

Final datasheet

CoolSiC™ 1200 V SiC Trench MOSFET

Features

- $V_{DS} = 1200\text{ V}$ at $T_{vj} = -55...175^\circ\text{C}$
- $I_{DC} = 100\text{ A}$ at $T_C = 25^\circ\text{C}$
- $R_{DS(on)} = 19\text{ m}\Omega$ at $V_{GS} = 20\text{ V}$, $T_{vj} = 25^\circ\text{C}$
- New performance-optimized chip technology (Gen1p) with improved $R_{DS(on)}$ * A FOM
- Increased recommended turn-on voltage ($V_{GS(on)} = 20\text{ V}$) for lower $R_{DS(on)}$
- Best in class switching energy for lower switching losses and reduced cooling efforts
- Lowest device capacitances for higher switching speeds and higher power density
- A combination of low C_{rSS}/C_{iSS} ratio and high $V_{GS(th)}$ to avoid parasitic turn-on and enable unipolar gate driving
- Reduced total gate charge Q_{Gtot} for lower driving power and losses
- .XT die attach technology for best in class thermal performance
- Sense pin for optimized switching performance
- Suitable for HV creepage requirements

Potential applications

- On-board charger
- DC/DC converter
- Auxiliary drives

Product validation

- Qualified for Automotive Applications. Product Validation according to AEC-Q100/101

Description

Pin definition:

- 1 – drain
- 2 – source
- 3 – Kelvin sense contact
- 4 – gate

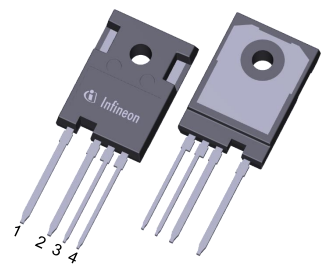
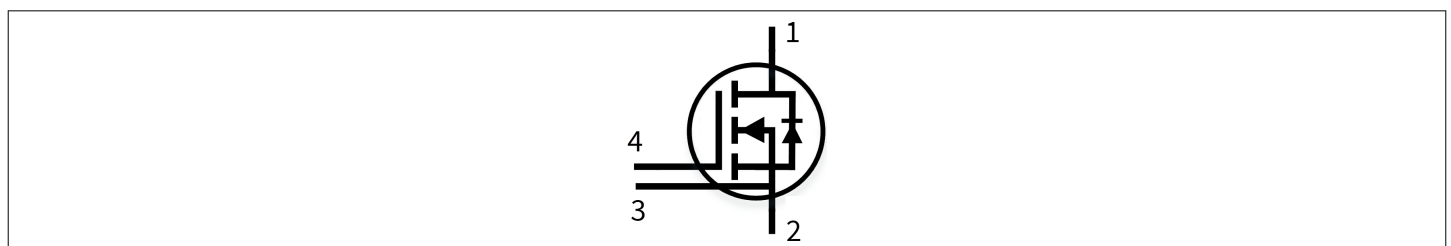

- Halogen-free
- Green
- Lead-free
- RoHS
- AEC-Q100 Qualified

Type	Package	Marking
AIMZH120R020M1T	PG-TO247-4-STD-NT6.7	A12M1T020

Table of contents

	Description	1
	Features	1
	Potential applications	1
	Product validation	1
	Table of contents	2
1	Package	3
2	MOSFET	3
3	Body diode (MOSFET)	5
4	Characteristics diagrams	7
5	Package outlines	12
6	Testing conditions	13
	Revision history	14
	Disclaimer	15

1 Package

Table 1 Characteristic values

Parameter	Symbol	Note or test condition	Values			Unit
			Min.	Typ.	Max.	
Storage temperature	T_{stg}		-55		150	°C
Soldering temperature	T_{sold}				260	°C
MOSFET/body diode thermal resistance, junction-case	$R_{th(j-c)}$			0.27	0.35	K/W

Note: Not subject to production test. Parameter verified by design/characterization.

2 MOSFET

Table 2 Maximum rated values

Parameter	Symbol	Note or test condition	Values	Unit	
Drain-source voltage	V_{DSS}	$T_{vj} = -55...175\text{ °C}$	1200	V	
Continuous DC drain current for $R_{th(j-c,max)}$, limited by $T_{vj(max)}$	I_{DDC}	$V_{GS} = 20\text{ V}$	$T_c = 25\text{ °C}$	100	A
			$T_c = 100\text{ °C}$	71	
Peak drain current, t_p limited by $T_{vj(max)}$	I_{DM}	$V_{GS} = 20\text{ V}$	256	A	
Gate-source voltage, max. transient voltage ¹⁾	V_{GS}	$t_p \leq 0.5\ \mu\text{s}, D < 0.01$	-10...25	V	
Gate-source voltage, max. static voltage	V_{GS}		-5...23	V	
Avalanche energy, single pulse	E_{AS}	$I_D = 32\text{ A}, V_{DD} = 50\text{ V}, L = 0.67\text{ mH}$	340	mJ	
Power dissipation, limited by $T_{vj(max)}$	P_{tot}		$T_c = 25\text{ °C}$	429	W
			$T_c = 100\text{ °C}$	214	

1) **Important note:** The selection of positive and negative gate-source voltages impacts the long-term behavior of the device. The design guidelines described in Application Note AN2018-09 must be considered to ensure sound operation of the device over the planned lifetime.

Table 3 Recommended values

Parameter	Symbol	Note or test condition	Values	Unit
Recommended turn-on gate voltage	$V_{GS(on)}$		20	V
Recommended turn-off gate voltage	$V_{GS(off)}$		0	V

Table 4 Characteristic values

Parameter	Symbol	Note or test condition	Values			Unit	
			Min.	Typ.	Max.		
Drain-source on-state resistance	$R_{DS(on)}$	$I_D = 43\text{ A}$	$T_{vj} = 25\text{ °C}$, $V_{GS(on)} = 20\text{ V}$		19	25	mΩ
			$T_{vj} = 100\text{ °C}$, $V_{GS(on)} = 20\text{ V}$		27		
			$T_{vj} = 175\text{ °C}$, $V_{GS(on)} = 20\text{ V}$		38		
			$T_{vj} = 25\text{ °C}$, $V_{GS(on)} = 18\text{ V}$		20.6		
Gate-source threshold voltage	$V_{GS(th)}$	$I_D = 13.7\text{ mA}$, $V_{DS} = V_{GS}$ (tested after 1 ms pulse at $V_{GS} = 20\text{ V}$)	$T_{vj} = 25\text{ °C}$	3.5	4.3	5.1	V
			$T_{vj} = 175\text{ °C}$		3.8		
Zero gate-voltage drain current	I_{DSS}	$V_{DS} = 1200\text{ V}$, $V_{GS} = 0\text{ V}$	$T_{vj} = 25\text{ °C}$		0.6	42	μA
			$T_{vj} = 175\text{ °C}$		50		
Gate leakage current	I_{GSS}	$V_{DS} = 0\text{ V}$	$V_{GS} = 25\text{ V}$			100	nA
			$V_{GS} = -10\text{ V}$			-100	
Forward transconductance	g_{fs}	$I_D = 43\text{ A}$, $V_{DS} = 20\text{ V}$			27		S
Short-circuit withstand time ¹⁾	t_{SC}	$V_{DD} \leq 800\text{ V}$, $V_{DS,peak} < 1200\text{ V}$, $T_{vj(start)} = 25\text{ °C}$, $R_{G,ext} = 2\text{ }\Omega$	$V_{GS(on)} = 20\text{ V}$		1.5		μs
			$V_{GS(on)} = 18\text{ V}$		2		
			$V_{GS(on)} = 15\text{ V}$		2.5		
Internal gate resistance	$R_{G,int}$	$f = 1\text{ MHz}$, $V_{AC} = 25\text{ mV}$			2.2		Ω
Input capacitance	C_{iss}	$V_{DD} = 800\text{ V}$, $V_{GS} = 0\text{ V}$, $f = 100\text{ kHz}$, $V_{AC} = 25\text{ mV}$			2667		pF
Output capacitance	C_{oss}	$V_{DD} = 800\text{ V}$, $V_{GS} = 0\text{ V}$, $f = 100\text{ kHz}$, $V_{AC} = 25\text{ mV}$			126		pF
Reverse transfer capacitance	C_{riss}	$V_{DD} = 800\text{ V}$, $V_{GS} = 0\text{ V}$, $f = 100\text{ kHz}$, $V_{AC} = 25\text{ mV}$			7		pF
C_{oss} stored energy	E_{oss}	$V_{DD} = 800\text{ V}$, $V_{GS} = 0\text{ V}$, $f = 100\text{ kHz}$, $V_{AC} = 25\text{ mV}$			52		μJ
Total gate charge	Q_G	$V_{DD} = 800\text{ V}$, $I_D = 43\text{ A}$, $V_{GS} = 0/20\text{ V}$, turn-on pulse			82		nC
Plateau gate charge	$Q_{GS(pl)}$	$V_{DD} = 800\text{ V}$, $I_D = 43\text{ A}$, $V_{GS} = 0/20\text{ V}$, turn-on pulse			22		nC
Gate-to-drain charge	Q_{GD}	$V_{DD} = 800\text{ V}$, $I_D = 43\text{ A}$, $V_{GS} = 0/20\text{ V}$, turn-on pulse			14		nC
Turn-on delay time	$t_{d(on)}$	$V_{DD} = 800\text{ V}$, $I_D = 43\text{ A}$, $V_{GS} = 0/20\text{ V}$, $R_{GS(on)} = 2\text{ }\Omega$, $R_{GS(off)} = 2\text{ }\Omega$, $L_\sigma = 15\text{ nH}$	$T_{vj} = 25\text{ °C}$		13		ns
			$T_{vj} = 175\text{ °C}$		13		

(table continues...)

Table 4 (continued) **Characteristic values**

Parameter	Symbol	Note or test condition	Values			Unit
			Min.	Typ.	Max.	
Rise time	t_r	$V_{DD} = 800 \text{ V}, I_D = 43 \text{ A},$ $V_{GS} = 0/20 \text{ V},$ $R_{GS(on)} = 2 \Omega,$ $R_{GS(off)} = 2 \Omega, L_\sigma = 15 \text{ nH}$	$T_{vj} = 25 \text{ }^\circ\text{C}$	11		ns
			$T_{vj} = 175 \text{ }^\circ\text{C}$	16		
Turn-off delay time	$t_{d(off)}$	$V_{DD} = 800 \text{ V}, I_D = 43 \text{ A},$ $V_{GS} = 0/20 \text{ V},$ $R_{GS(on)} = 2 \Omega,$ $R_{GS(off)} = 2 \Omega, L_\sigma = 15 \text{ nH}$	$T_{vj} = 25 \text{ }^\circ\text{C}$	27		ns
			$T_{vj} = 175 \text{ }^\circ\text{C}$	31		
Fall time	t_f	$V_{DD} = 800 \text{ V}, I_D = 43 \text{ A},$ $V_{GS} = 0/20 \text{ V},$ $R_{GS(on)} = 2 \Omega,$ $R_{GS(off)} = 2 \Omega, L_\sigma = 15 \text{ nH}$	$T_{vj} = 25 \text{ }^\circ\text{C}$	8		ns
			$T_{vj} = 175 \text{ }^\circ\text{C}$	9		
Turn-on energy	E_{on}	$V_{DD} = 800 \text{ V}, I_D = 43 \text{ A},$ $V_{GS} = 0/20 \text{ V},$ $R_{GS(on)} = 2 \Omega,$ $R_{GS(off)} = 2 \Omega, L_\sigma = 15 \text{ nH}$	$T_{vj} = 25 \text{ }^\circ\text{C}$	283		μJ
			$T_{vj} = 175 \text{ }^\circ\text{C}$	468		
Turn-off energy	E_{off}	$V_{DD} = 800 \text{ V}, I_D = 43 \text{ A},$ $V_{GS} = 0/20 \text{ V},$ $R_{GS(on)} = 2 \Omega,$ $R_{GS(off)} = 2 \Omega, L_\sigma = 15 \text{ nH}$	$T_{vj} = 25 \text{ }^\circ\text{C}$	145		μJ
			$T_{vj} = 175 \text{ }^\circ\text{C}$	164		
Total switching energy	E_{tot}	$V_{DD} = 800 \text{ V}, I_D = 43 \text{ A},$ $V_{GS} = 0/20 \text{ V},$ $R_{GS(on)} = 2 \Omega,$ $R_{GS(off)} = 2 \Omega, L_\sigma = 15 \text{ nH}$	$T_{vj} = 25 \text{ }^\circ\text{C}$	428		μJ
			$T_{vj} = 175 \text{ }^\circ\text{C}$	632		
Virtual junction temperature	T_{vj}		-55		175	$^\circ\text{C}$

1) verified by the design/characterization

Note: Dynamic test circuit see Fig. F.

3 Body diode (MOSFET)

Table 5 **Maximum rated values**

Parameter	Symbol	Note or test condition	Values	Unit	
Drain-source voltage	V_{DSS}	$T_{vj} = -55\dots175 \text{ }^\circ\text{C}$	1200	V	
Continuous reverse drain current for $R_{th(j-c,max)}$, limited by $T_{vj(max)}$	I_{SDC}	$V_{GS} = 0 \text{ V}$	$T_c = 25 \text{ }^\circ\text{C}$	83	A
			$T_c = 100 \text{ }^\circ\text{C}$	49	
Peak reverse drain current, t_p limited by $T_{vj(max)}$	I_{SM}	$V_{GS} = 0 \text{ V}$	95	A	

Table 6 Characteristic values

Parameter	Symbol	Note or test condition	Values			Unit	
			Min.	Typ.	Max.		
Drain-source reverse voltage	V_{SD}	$I_{SD} = 43 \text{ A}, V_{GS} = 0 \text{ V}$	$T_{vj} = 25 \text{ °C}$		3.9	5	V
			$T_{vj} = 100 \text{ °C}$		3.8		
			$T_{vj} = 175 \text{ °C}$		3.7		
MOSFET forward recovery charge	Q_{fr}	$V_{DD} = 800 \text{ V},$ $I_{SD} = 43 \text{ A}, V_{GS} = 0 \text{ V},$ $di_{SD}/dt = 3000 \text{ A}/\mu\text{s}, Q_{fr}$ includes also Q_C	$T_{vj} = 25 \text{ °C}$		290		nC
			$T_{vj} = 175 \text{ °C}$		643		
MOSFET peak forward recovery current	I_{frm}	$V_{DD} = 800 \text{ V},$ $I_{SD} = 43 \text{ A}, V_{GS} = 0 \text{ V},$ $di_{SD}/dt = 3000 \text{ A}/\mu\text{s}, Q_{fr}$ includes also Q_C	$T_{vj} = 25 \text{ °C}$		10		A
			$T_{vj} = 175 \text{ °C}$		30		
Virtual junction temperature	T_{vj}			-55		175	°C

4 Characteristics diagrams

Reverse bias safe operating area (RBSOA)

$$I_{DS} = f(V_{DS})$$

$$T_{vj} \leq 175\text{ °C}, V_{GS} = 0/20\text{ V}, T_c = 25\text{ °C}$$

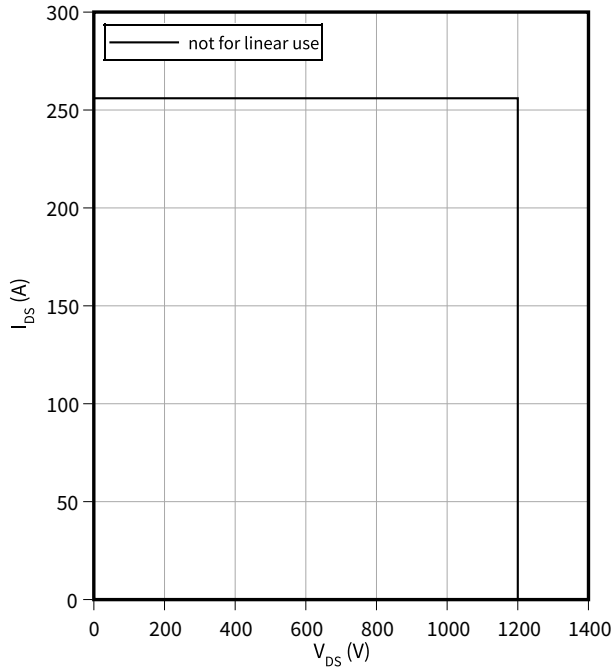

Power dissipation as a function of case temperature

$$P_{tot} = f(T_c)$$

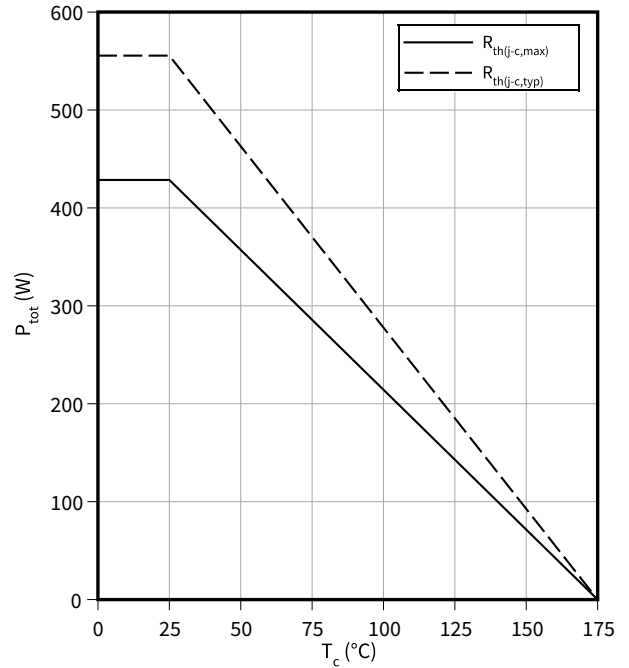

Maximum DC drain to source current as a function of case temperature

$$I_{DS} = f(T_c)$$

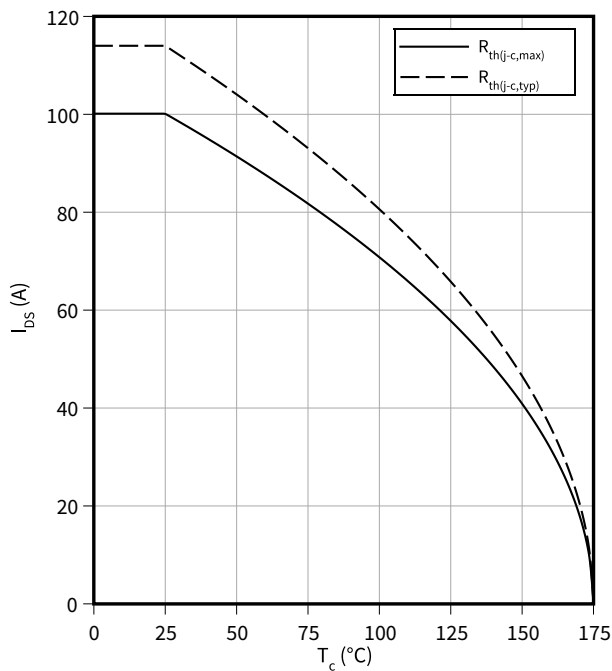

Maximum source to drain current as a function of case temperature

$$I_{SD} = f(T_c)$$

$$V_{GS} = 0\text{ V}$$

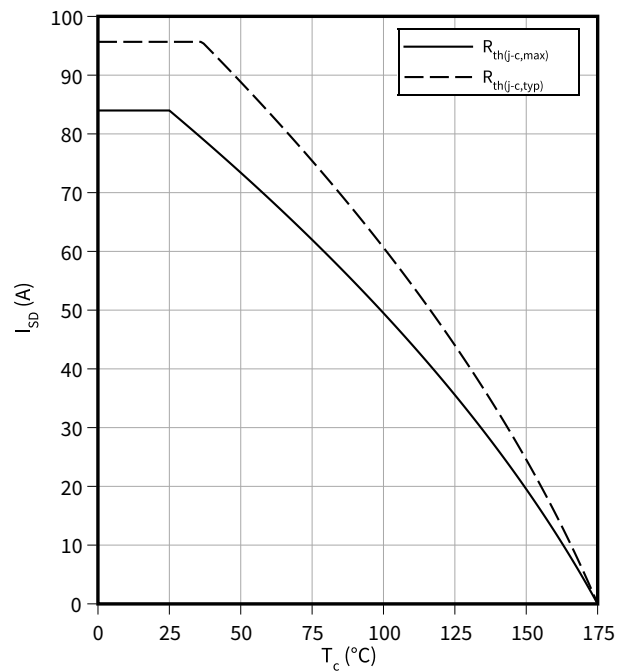

4 Characteristics diagrams

Typical transfer characteristic

$I_{DS} = f(V_{GS})$
 $V_{DS} = 20\text{ V}$

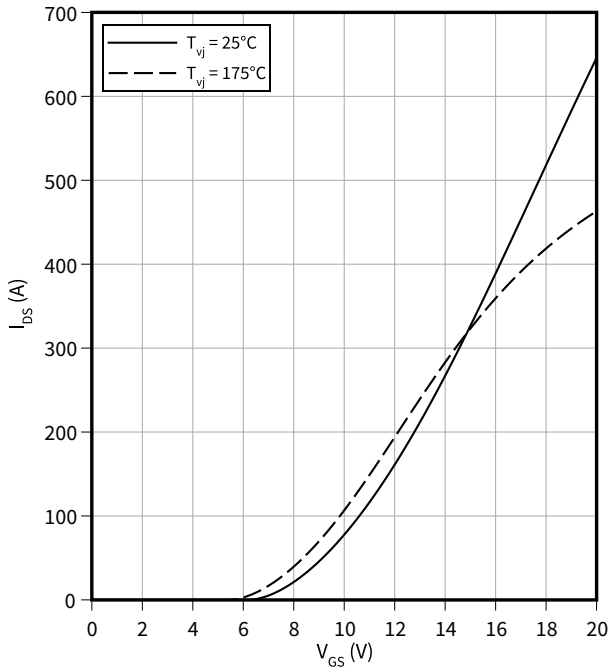

Typical gate-source threshold voltage as a function of junction temperature

$V_{GS(th)} = f(T_{vj})$
 $I_D = 13.7\text{ mA}$

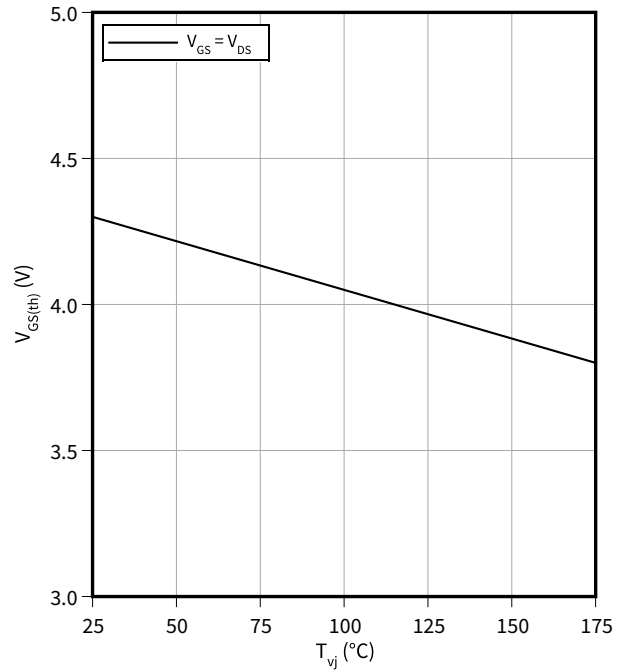

Typical output characteristic, V_{GS} as parameter

$I_{DS} = f(V_{DS})$
 $T_{vj} = 25\text{ °C}$

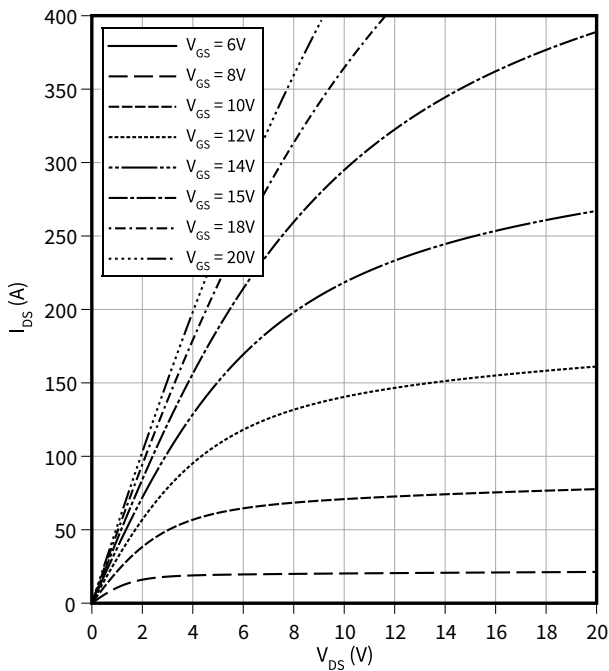

Typical output characteristic, V_{GS} as parameter

$I_{DS} = f(V_{DS})$
 $T_{vj} = 175\text{ °C}$

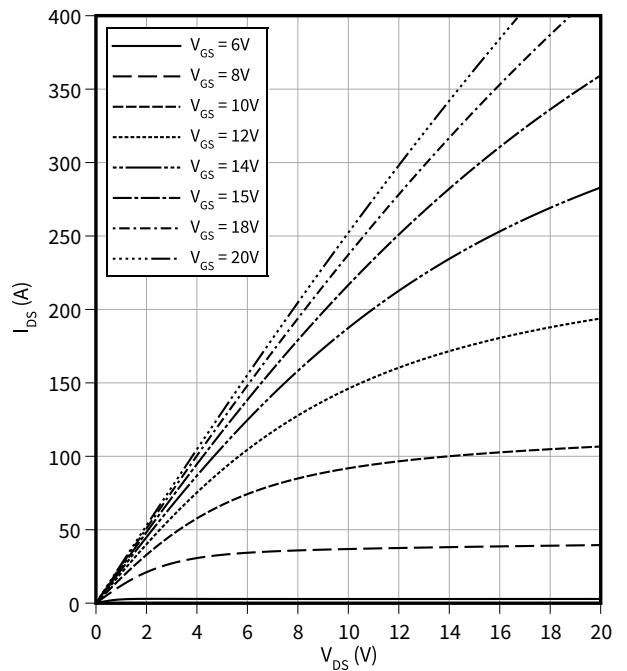

4 Characteristics diagrams

Typical on-state resistance as a function of junction temperature

$R_{DS(on)} = f(T_{vj})$
 $I_D = 43 \text{ A}$

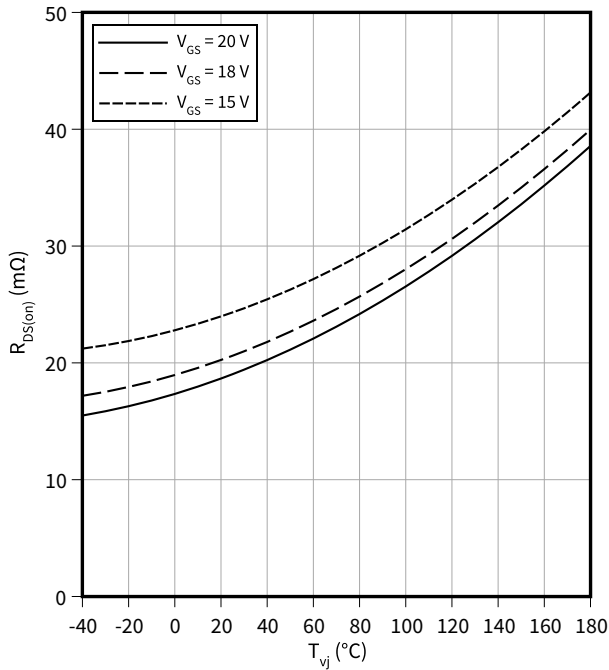

Typical gate charge

$V_{GS} = f(Q_G)$
 $I_D = 43 \text{ A}, V_{DS} = 800 \text{ V}$

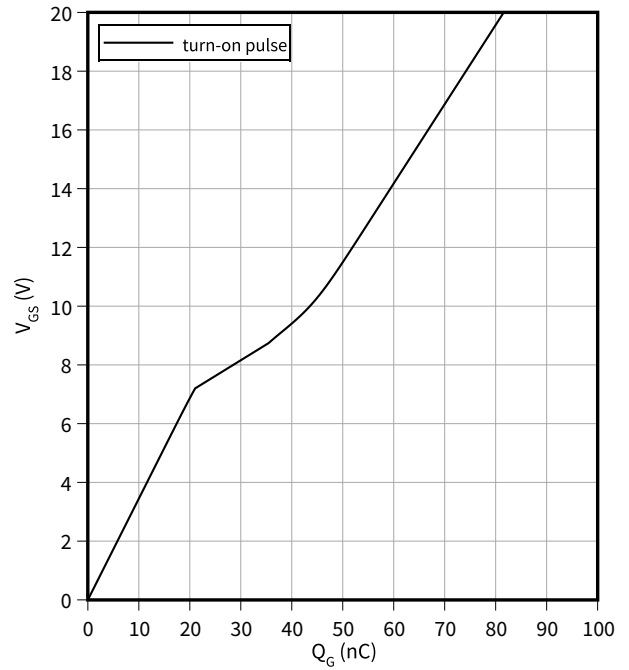

Typical capacitance as a function of drain-source voltage

$C = f(V_{DS})$
 $f = 100 \text{ kHz}, V_{GS} = 0 \text{ V}$

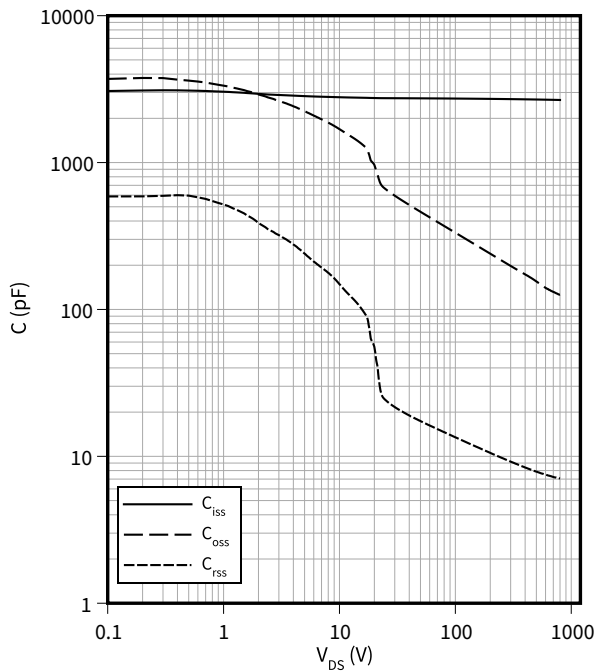

Typical reverse drain voltage as function of junction temperature

$V_{SD} = f(T_{vj})$
 $I_{SD} = 43 \text{ A}, V_{GS} = 0 \text{ V}$

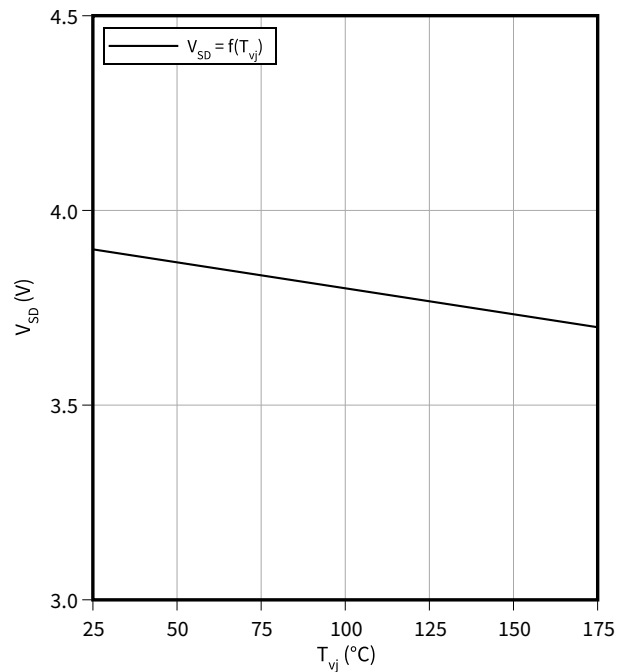

4 Characteristics diagrams

Typical reverse drain current as function of reverse drain voltage, V_{GS} as parameter

$I_{SD} = f(V_{SD})$
 $T_{vj} = 25\text{ °C}$

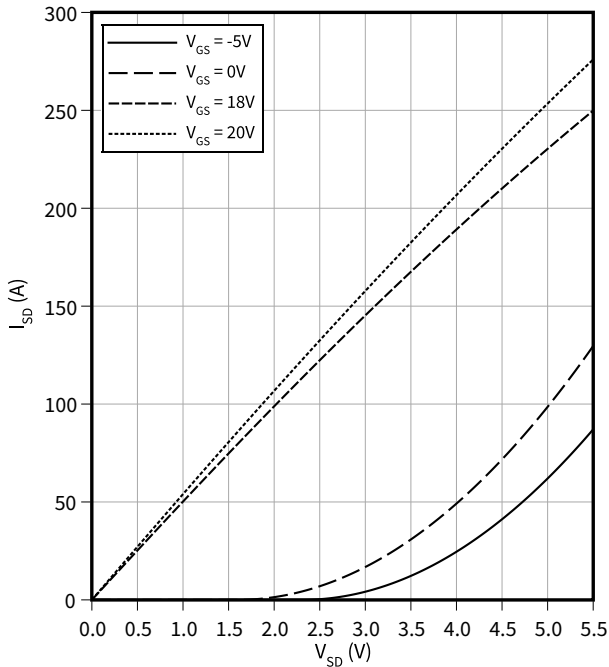

Typical reverse drain current as function of reverse drain voltage, V_{GS} as parameter

$I_{SD} = f(V_{SD})$
 $T_{vj} = 175\text{ °C}$

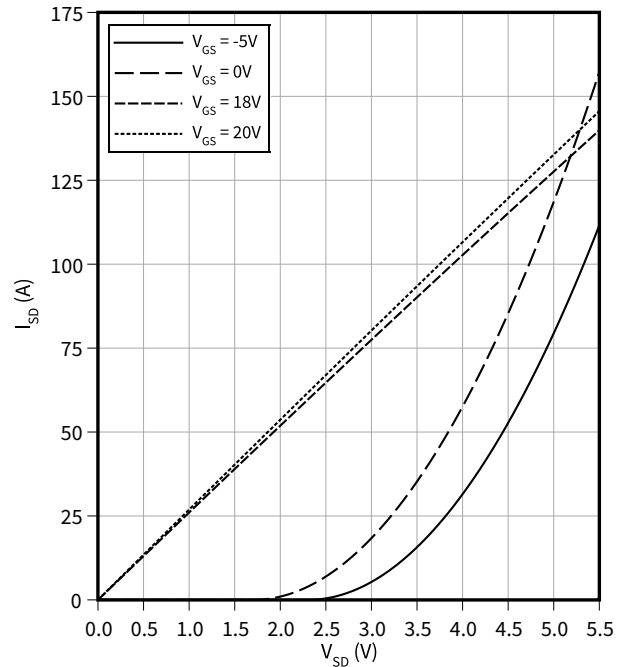

Typical switching energy as a function of junction temperature, test circuit in Fig. F, 2nd device own body diode: $V_{GS} = 0\text{ V}$

$E = f(T_{vj})$
 $V_{GS} = 0/20\text{ V}$, $I_D = 43\text{ A}$, $R_{G,ext} = 2\text{ }\Omega$, $V_{DD} = 800\text{ V}$

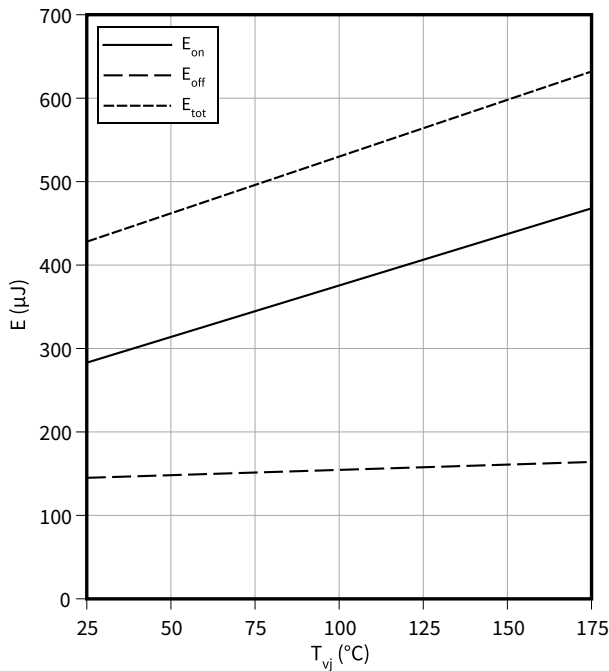

Typical switching energy as a function of drain current, test circuit in Fig. F, 2nd device own body diode: $V_{GS} = 0\text{ V}$

$E = f(I_D)$
 $V_{GS} = 0/20\text{ V}$, $T_{vj} = 175\text{ °C}$, $R_{G,ext} = 2\text{ }\Omega$, $V_{DD} = 800\text{ V}$

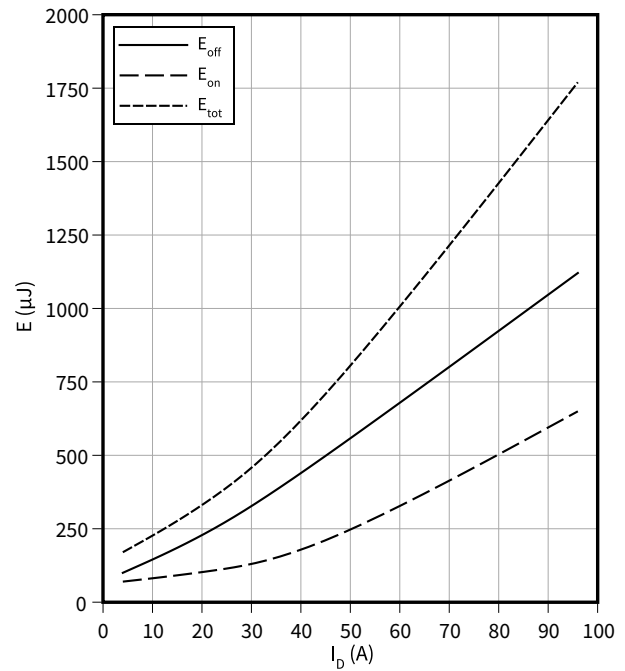

4 Characteristics diagrams

Typical switching energy as a function of gate resistance, test circuit in Fig. F, 2nd device own body diode: $V_{GS} = 0\text{ V}$

$E = f(R_{G,ext})$

$V_{GS} = 0/20\text{ V}$, $I_D = 43\text{ A}$, $T_{vj} = 175\text{ °C}$, $V_{DD} = 800\text{ V}$

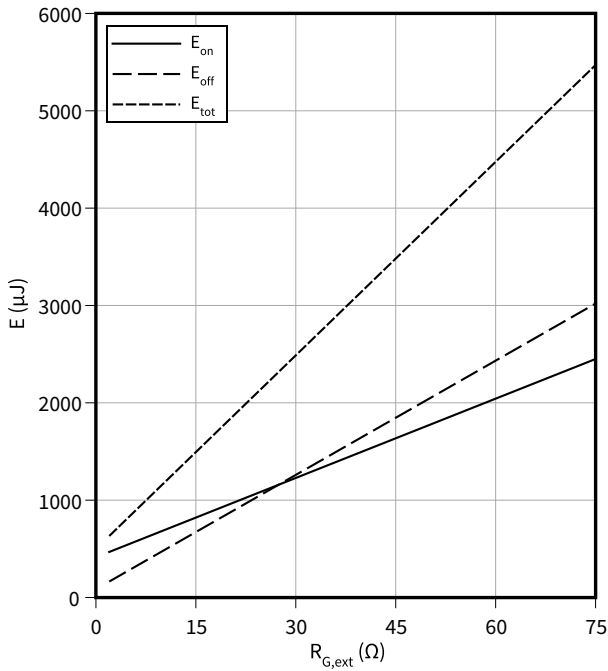

Typical switching times as a function of gate resistance, test circuit in Fig. F, 2nd device own body diode: $V_{GS} = 0\text{ V}$

$t = f(R_{G,ext})$

$V_{GS} = 0/20\text{ V}$, $I_D = 43\text{ A}$, $T_{vj} = 175\text{ °C}$, $V_{DD} = 800\text{ V}$

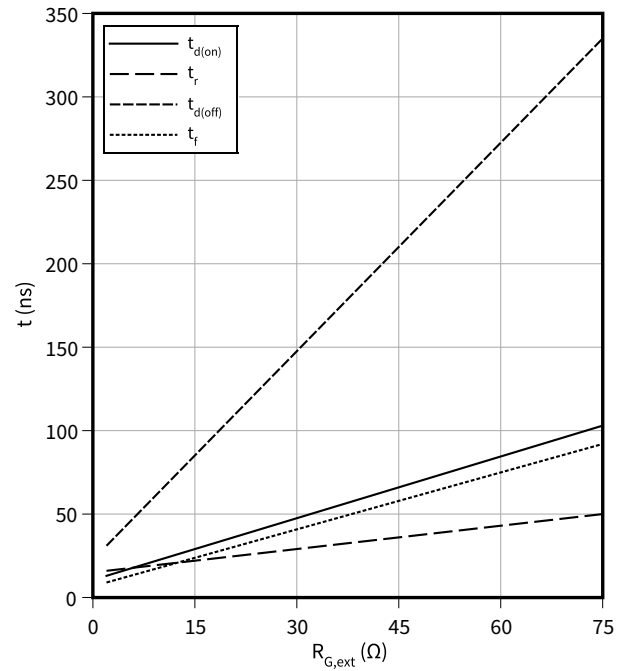

Max. transient thermal impedance (MOSFET/diode)

$Z_{th(j-c),max} = f(t_p)$

$D = t_p/T$

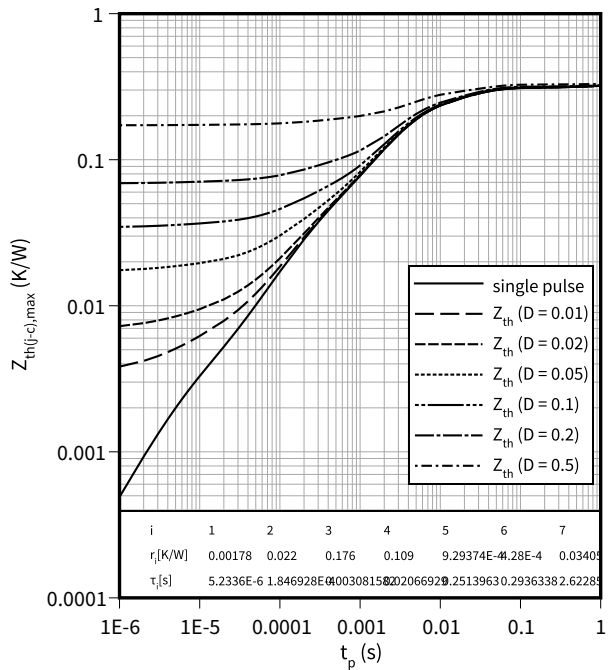

5 Package outlines

PG-TO247-4-STD-NT6.7

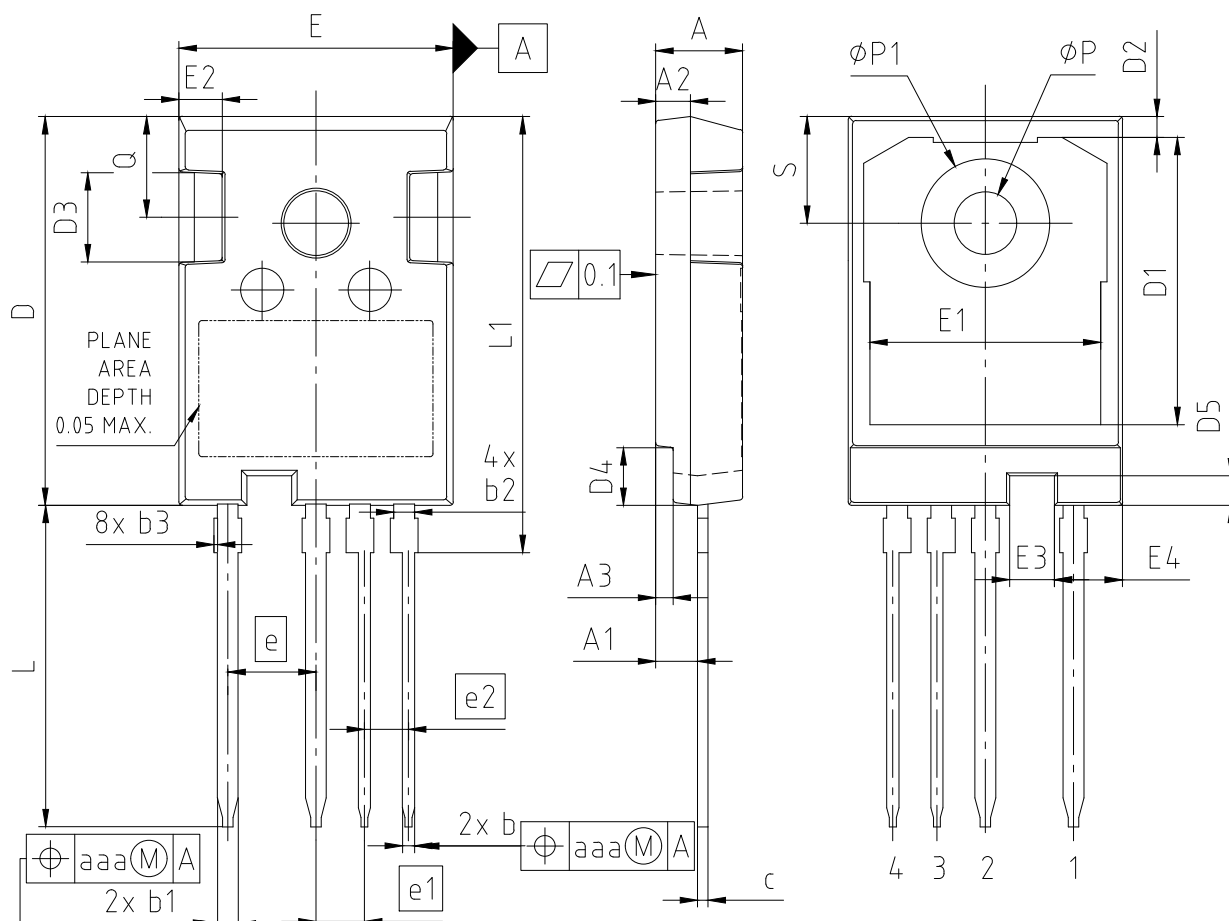

PACKAGE - GROUP NUMBER: **PG-TO247-4-U03**

DIMENSIONS	MILLIMETERS		DIMENSIONS	MILLIMETERS	
	MIN.	MAX.		MIN.	MAX.
A	4.90	5.10	E	15.70	15.90
A1	2.31	2.51	E1	13.10	13.50
A2	1.90	2.10	E2	2.40	2.60
A3	0.90	1.10	E3	2.48	2.68
b	0.66	0.79	E4	3.82	4.02
b1	1.16	1.29	e	5.08	
b2	1.16	1.29	e1	2.79	
b3		0.20	e2	2.54	
c	0.59	0.66	N	4	
D	22.30	22.50	L	18.40	18.70
D1	16.25	16.85	L1	24.97	25.27
D2	1.05	1.35	øP	3.50	3.70
D3	5.00	5.20	øP1		7.40
D4	3.22	3.42	S	6.00	6.30
D5	1.60	1.80	aaa	0.25	

NOTE: DIMENSIONS DO NOT INCLUDE MOLDFLASH; PROTRUSION OR GARE BURRS

Figure 1

6 Testing conditions

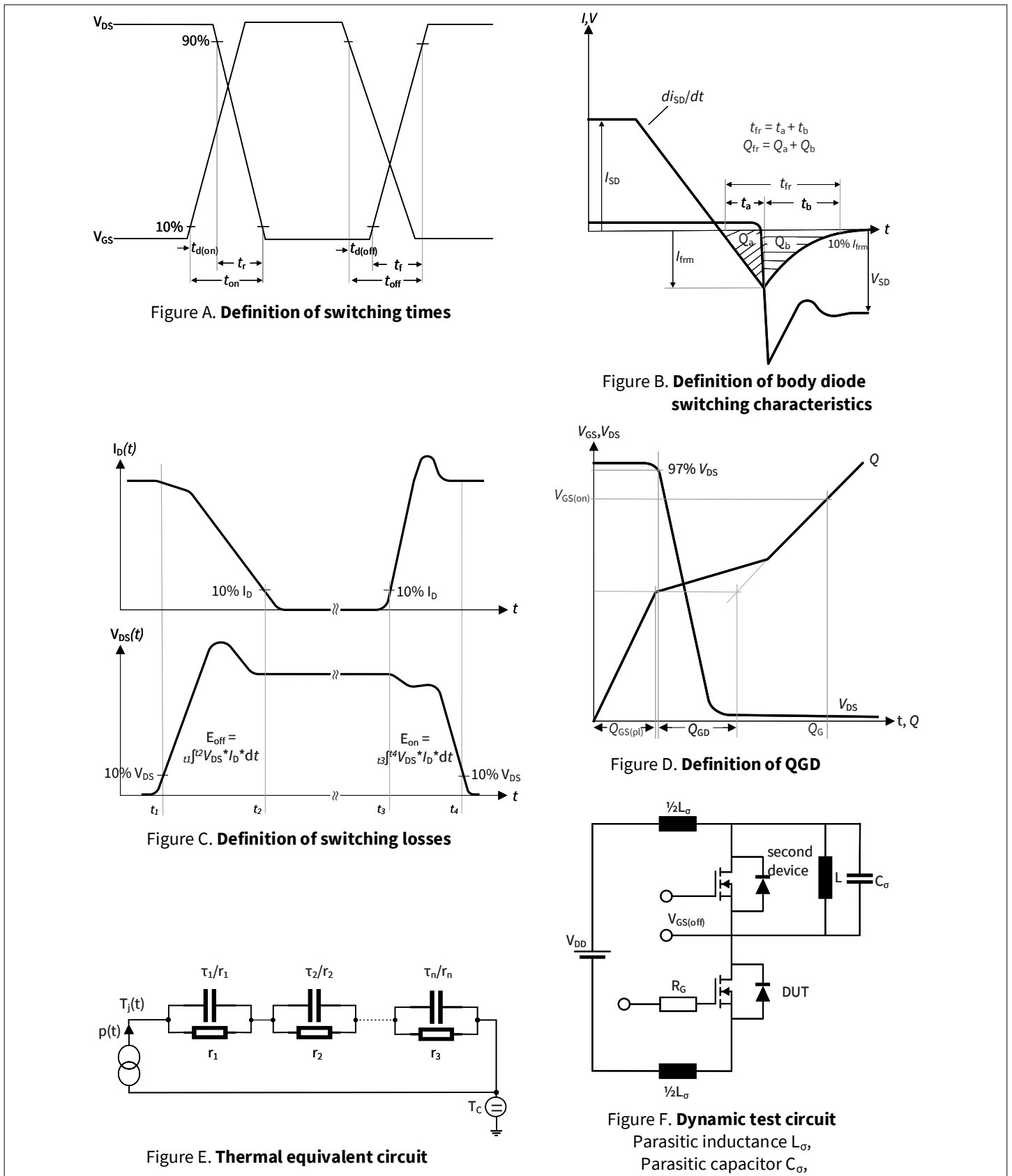

Figure 2

Revision history

Revision history

Document revision	Date of release	Description of changes
0.10	2022-04-19	Target datasheet
0.20	2023-07-31	Preliminary datasheet
0.30	2023-08-03	Correction of inductance unit (p. 3) Correction of diagram template E(Id)
1.00	2023-11-29	Final datasheet

Trademarks

All referenced product or service names and trademarks are the property of their respective owners.

Edition 2023-11-29

Published by

Infineon Technologies AG

81726 Munich, Germany

© 2023 Infineon Technologies AG

All Rights Reserved.

Do you have a question about any aspect of this document?

Email: erratum@infineon.com

Document reference

IFX-ABE568-004

Important notice

The information given in this document shall in no event be regarded as a guarantee of conditions or characteristics ("Beschaffheitsgarantie").

With respect to any examples, hints or any typical values stated herein and/or any information regarding the application of the product, Infineon Technologies hereby disclaims any and all warranties and liabilities of any kind, including without limitation warranties of non-infringement of intellectual property rights of any third party.

In addition, any information given in this document is subject to customer's compliance with its obligations stated in this document and any applicable legal requirements, norms and standards concerning customer's products and any use of the product of Infineon Technologies in customer's applications.

The data contained in this document is exclusively intended for technically trained staff. It is the responsibility of customer's technical departments to evaluate the suitability of the product for the intended application and the completeness of the product information given in this document with respect to such application.

Warnings

Due to technical requirements products may contain dangerous substances. For information on the types in question please contact your nearest Infineon Technologies office.

Except as otherwise explicitly approved by Infineon Technologies in a written document signed by authorized representatives of Infineon Technologies, Infineon Technologies' products may not be used in any applications where a failure of the product or any consequences of the use thereof can reasonably be expected to result in personal injury.