

BFP840FESD

High Gain Low Noise Amplifier using
BFP840FESD for 2.4 - 2.5 GHz WLAN
Application

Application Note AN320

Revision: Rev. 1.0
2013-03-27

Edition 2013-03-27

**Published by
Infineon Technologies AG
81726 Munich, Germany
© 2013 Infineon Technologies AG
All Rights Reserved.**

Legal Disclaimer

The information given in this document shall in no event be regarded as a guarantee of conditions or characteristics. With respect to any examples or hints given herein, any typical values stated herein and/or any information regarding the application of the device, Infineon Technologies hereby disclaims any and all warranties and liabilities of any kind, including without limitation, warranties of non-infringement of intellectual property rights of any third party.

Information

For further information on technology, delivery terms and conditions and prices, please contact the nearest Infineon Technologies Office (www.infineon.com).

Warnings

Due to technical requirements, components may contain dangerous substances. For information on the types in question, please contact the nearest Infineon Technologies Office.

Infineon Technologies components may be used in life-support devices or systems only with the express written approval of Infineon Technologies, if a failure of such components can reasonably be expected to cause the failure of that life-support device or system or to affect the safety or effectiveness of that device or system. Life support devices or systems are intended to be implanted in the human body or to support and/or maintain and sustain and/or protect human life. If they fail, it is reasonable to assume that the health of the user or other persons may be endangered.

Application Note AN320

Revision History: 2013-03-27

Previous Revision: No previous revision

| Page | Subjects (major changes since last revision) |
|------|--|
| | |
| | |
| | |
| | |
| | |
| | |
| | |
| | |

Trademarks of Infineon Technologies AG

AURIX™, C166™, CanPAK™, CIPOS™, CIPURSE™, EconoPACK™, CoolMOS™, CoolSET™, CORECONTROL™, CROSSAVE™, DAVE™, DI-POL™, EasyPIM™, EconoBRIDGE™, EconoDUAL™, EconoPIM™, EconoPACK™, EiceDRIVER™, eupec™, FCOS™, HITFET™, HybridPACK™, I²RF™, ISOFACE™, IsoPACK™, MIPAQ™, ModSTACK™, my-d™, NovalithIC™, OptiMOS™, ORIGA™, POWERCODE™, PRIMARION™, PrimePACK™, PrimeSTACK™, PRO-SIL™, PROFET™, RASIC™, ReversSave™, SatRIC™, SIEGET™, SINDRION™, SIPMOS™, SmartLEWIS™, SOLID FLASH™, TEMPFET™, thinQ!™, TRENCHSTOP™, TriCore™.

Other Trademarks

Advance Design System™ (ADS) of Agilent Technologies, AMBA™, ARM™, MULTI-ICE™, KEIL™, PRIMECELL™, REALVIEW™, THUMB™, µVision™ of ARM Limited, UK. AUTOSAR™ is licensed by AUTOSAR development partnership. Bluetooth™ of Bluetooth SIG Inc. CAT-iq™ of DECT Forum. COLOSSUS™, FirstGPS™ of Trimble Navigation Ltd. EMV™ of EMVCo, LLC (Visa Holdings Inc.). EPCOS™ of Epcos AG. FLEXGO™ of Microsoft Corporation. FlexRay™ is licensed by FlexRay Consortium. HYPERTERMINAL™ of Hilgraeve Incorporated. IEC™ of Commission Electrotechnique Internationale. IrDA™ of Infrared Data Association Corporation. ISO™ of INTERNATIONAL ORGANIZATION FOR STANDARDIZATION. MATLAB™ of MathWorks, Inc. MAXIM™ of Maxim Integrated Products, Inc. MICROTEC™, NUCLEUS™ of Mentor Graphics Corporation. MIPI™ of MIPI Alliance, Inc. MIPS™ of MIPS Technologies, Inc., USA. muRata™ of MURATA MANUFACTURING CO., MICROWAVE OFFICE™ (MWO) of Applied Wave Research Inc., OmniVision™ of OmniVision Technologies, Inc. Openwave™ Openwave Systems Inc. RED HAT™ Red Hat, Inc. RFMD™ RF Micro Devices, Inc. SIRIUS™ of Sirius Satellite Radio Inc. SOLARIS™ of Sun Microsystems, Inc. SPANSION™ of Spansion LLC Ltd. Symbian™ of Symbian Software Limited. TAIYO YUDEN™ of Taiyo Yuden Co. TEAKLITE™ of CEVA, Inc. TEKTRONIX™ of Tektronix Inc. TOKO™ of TOKO KABUSHIKI KAISHA TA. UNIX™ of X/Open Company Limited. VERILOG™, PALLADIUM™ of Cadence Design Systems, Inc. VLYNQ™ of Texas Instruments Incorporated. VXWORKS™, WIND RIVER™ of WIND RIVER SYSTEMS, INC. ZETEX™ of Diodes Zetex Limited.

Last Trademarks Update 2011-11-11

Table of Content

| | | |
|----------|--|-----------|
| 1 | Introduction | 5 |
| 1.1 | Wi-Fi® | 5 |
| 2 | BFP840FESD Overview | 7 |
| 2.1 | Features | 7 |
| 2.2 | Key Applications of BFP840FESD | 7 |
| 3 | High Gain Low Noise Amplifier using BFP840FESD for 2.4 – 2.5 GHz WLAN Application | 8 |
| 3.1 | Description | 8 |
| 3.2 | Performance overview | 10 |
| 3.3 | Schematics | 11 |
| 4 | Measured Graphs | 12 |
| 5 | Evaluation Board and Layout Information | 19 |
| 6 | Authors | 21 |
| 7 | Remark | 21 |

List of Figures

| | | |
|-----------|---|----|
| Figure 1 | 2.4 – 2.5 GHz Wi-Fi® Wireless LAN (WLAN, IEEE802.11b/g/n) and WiMAX (IEEE802.16e) Front-End | 6 |
| Figure 2 | BFP840FESD in TSFP-4-1 | 7 |
| Figure 3 | Package and pin connections of BFP840FESD in Topview | 8 |
| Figure 4 | Schematic Diagram of the used Circuit | 11 |
| Figure 5 | Insertion Power Gain of the 2.4 – 2.5 GHz WLAN LNA with BFP840FESD | 12 |
| Figure 6 | Wideband Insertion Power Gain of the 2.4 – 2.5 GHz WLAN LNA with BFP840FESD | 12 |
| Figure 7 | Noise Figure of BFP840FESD LNA for 2400 - 2500 MHz | 13 |
| Figure 8 | Reverse Isolation of the 2.4 – 2.5 GHz WLAN LNA with BFP840FESD | 13 |
| Figure 9 | Input Matching of the 2.4 – 2.5 GHz WLAN LNA with BFP840FESD | 14 |
| Figure 10 | Input Matching of the 2.4 – 2.5 GHz WLAN LNA with BFP840FESD (Smith Chart) | 14 |
| Figure 11 | Output Matching of the 2.4 – 2.5 GHz WLAN LNA with BFP840FESD | 15 |
| Figure 12 | Output Matching of the 2.4 – 2.5 GHz WLAN LNA with BFP840FESD (Smith Chart) | 15 |
| Figure 13 | Wideband Stability k Factor of the 2.4 – 2.5 GHz WLAN LNA with BFP840FESD | 16 |
| Figure 14 | Wideband Stability Mu Factor of the 2.4 – 2.5 GHz WLAN LNA with BFP840FESD | 16 |
| Figure 15 | Input 1dB Compression Point of the BFP840FESD Circuit at 2400 MHz | 17 |
| Figure 16 | Output 3 rd Order Intercept Point of BFP840FESD at 2400 MHz | 17 |
| Figure 17 | OFF-Mode (Vcc = 0V, Icc = 0mA) S21 of the 2.4 – 2.5 GHz WLAN LNA with BFP840FESD | 18 |
| Figure 18 | Photo of the BFP840FESD 2.4 – 2.5 GHz WLAN LNA Evaluation Board | 19 |
| Figure 19 | Zoom-In Picture of the BFP840FESD 2.4 – 2.5 GHz WLAN LNA Evaluation Board | 19 |
| Figure 20 | Layout Proposal for RF Grounding of the 2.4 – 2.5 GHz WLAN LNA with BFP840FESD | 20 |
| Figure 21 | PCB Layer Information | 20 |

List of Tables

| | | |
|---------|--------------------------------------|----|
| Table 1 | Summary of Measurement Results | 10 |
| Table 2 | Bill-of-Materials | 11 |

1 Introduction

1.1 Wi-Fi®

Wireless-Fidelity (Wi-Fi) is a registered trademark made of the Wi-Fi Alliance created to certify devices for wireless LAN (WLAN) applications based on the IEEE 802.11 standard. The Wi-Fi function is one of the most important connectivity functions in notebooks, smart phones and tablet PCs. The WLAN standard has evolved over the years from its legacy systems known as 802.11-1997, through 802.11a, b, g, and n, to the newest 802.11ac. Today the trend is rapidly changing where Wi-Fi is not only used for high data rate access to internet but also for content consumption such as streaming music and High Definition video on TVs, smart phones, tablets, game consoles etc.

With the requirements on wireless data quality becoming more stringent than ever, the new Wireless LAN standards are being developed by using higher order modulation schemes such as 256 Quadrature Amplitude Modulation (256-QAM), wider channels (40MHz) and multiple data streams up to 8 (MIMO-Multiple input multiple output).

Wi-Fi according to IEEE802.11b/g/n at 2.4 GHz widely implemented over years suffers from interference from other devices such as cordless phones, microwave ovens, Bluetooth devices etc. in the 2.4 GHz space. Different applications like home entertainment with wireless high-quality multimedia signal transmission, home networking notebooks, mass data storages and printers implement 2.4 – 2.5 GHz Wi-Fi® into their system to offer high-speed wireless connectivity. 802.11a operating at 5 GHz has less interference and can transmit data at greater speeds (54Mbps) but at the cost of reduced range. 802.11n provides enhanced performance and range over prior 802.11 technologies by operating in both the 2.4 GHz and 5 GHz. It adds two significant technologies: MIMO (Multiple input-Multiple output) and 40 MHz channels. With this, data rates upto 600Mbps (for 4 streams) can be achieved in the 5 GHz band. To cater to these high throughput requirements, major performance criteria have to be fulfilled: sensitivity, strong signal capability and interference immunity.

Below a general application diagram of a 2.4-2.5 GHz WLAN system is shown.

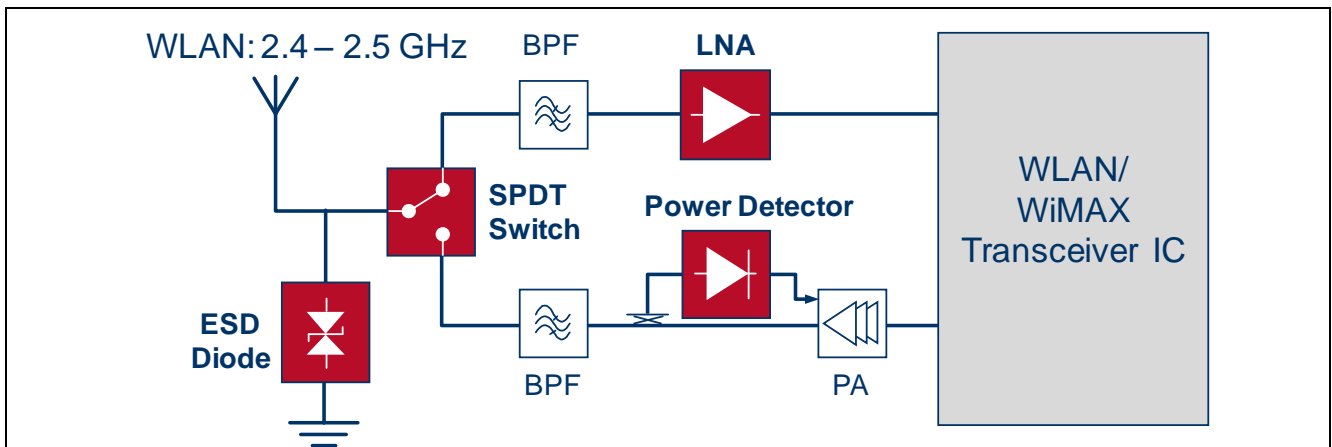

Figure 1 2.4 – 2.5 GHz Wi-Fi® Wireless LAN (WLAN, IEEE802.11b/g/n) and WiMAX (IEEE802.16e) Front-End

A Wi-Fi router has to receive relatively weak signals from Wi-Fi enabled devices such as mobile phones. Therefore, it should have high sensitivity to detect a weak signal in the presence of strong interfering signals. A low noise amplifier (LNA) as a first block of the receiver front end is mandatory to improve the sensitivity of the receiver and overcome the the insertion loss of the SPDT switch and the Bandpass Filter (BPF) or diplexer. As an example, an increase in the sensitivity by 5 dB corresponds to doubling the link distance. The typical allowed receiver chain Noise Figure (NF) of approx. 2 dB can only be achieved by using a high-gain low noise amplifier.

WLAN systems are subject to co-channel interference and also interference from strong co-existing cellular signals. High linearity characteristics such as IIP3 and Input 1dB compression point are required to improve an application's ability to distinguish between desired signals and spurious signals received close together. This avoids saturation, degradation of the gain and increased noise figure.

This application note is focusing on the LNA block, but Infineon does also support with [RF-switches](#), [TVS-diodes](#) for ESD protection and [RF Schottky diodes](#) for power detection.

2 BFP840FESD Overview

2.1 Features

- Robust ultra low noise amplifier based on Infineon's reliable high volume SiGe:C technology
- Unique combination of high end RF performance and robustness: 20 dBm maximum RF input power, 1.5 kV HBM ESD hardness
- Very high transition frequency $f_T = 85$ GHz enables best in class noise performance at high frequencies: $NF_{min} = 0.75$ dB at 5.5 GHz, 1.8 V, 5 mA
- High gain $|S_{21}|^2 = 19$ dB @ 5.5 GHz, 1.8 V, 10 mA
- $OIP3 = 22.5$ dBm at 5.5 GHz, 1.5 V, 6 mA
- Ideal for low voltage applications e.g. $V_{CC} = 1.2$ V and 1.8 V (2.85 V, 3.3 V, 3.6 V requires corresponding collector resistor)
- Low power consumption, ideal for mobile applications
- Pb free (RoHS compliant) and halogen free thin flat package with visible leads

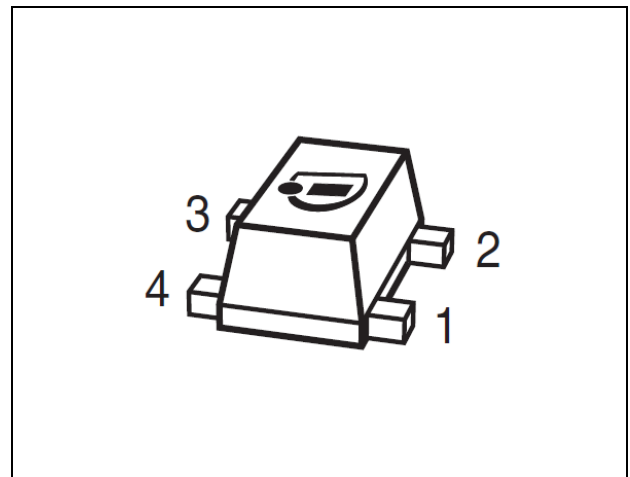

Figure 2 BFP840FESD in TSFP-4-1



2.2 Key Applications of BFP840FESD

As Low Noise Amplifier (LNA) in:

- Mobile and fixed connectivity applications: WLAN IEEE802.11, WiMAX and UWB
- Satellite communication systems: satellite radio (SDARs, DAB), navigation systems (e.g. GPS, GLONASS, COMPASS...) and satellite C-band LNB (1st and 2nd stage LNA)
- Ku-band LNB front-end (2nd stage or 3rd stage LNA and active mixer)
- Ka-band oscillators (DROs)

3 High Gain Low Noise Amplifier using BFP840FESD for 2.4 – 2.5 GHz WLAN Application

3.1 Description

The BFP840FESD is a discrete hetero-junction bipolar transistor (HBT) specifically designed for high performance 2.4 and 5 GHz band low noise amplifier (LNA) solutions for Wi-Fi connectivity applications. It combines the 80 GHz f_T silicon-germanium:carbide (SiGe:C) B9HFM process with special device geometry engineering to reduce the parasitic capacitance between substrate and transistor that degrades high-frequency characteristics, resulting in an inherent input matching and a major improvement in power gain 5 GHz band together with a low noise figure performance that is industry's best.

The BFP840FESD has an integrated 1.5kV HBM ESD protection which makes the device robust against electrostatic discharge and extreme RF input power. The device offers its high performance at low current and voltage and is especially well-suited for portable battery powered applications in which energy efficiency is a key requirement.

The BFP840FESD is housed in flat-leads TSFP-4-1 package. Further variants are available in industry standard visible-leads SOT343 package (BFP840ESD) and in the low-height 0.31mm TSLP-3-9 package (BFR840L3RHESD) specially fitting into modules.

Figure 3 shows the pin assignment of package of BFP840FESD in the top view:

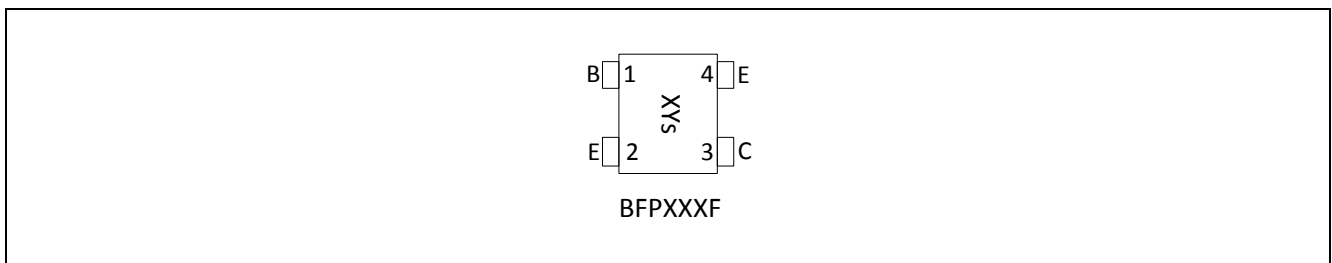

Figure 3 Package and pin connections of BFP840FESD in Topview

This application note presents the measurement results of the Low Noise Amplifier using BFP840FESD for 2400 MHz to 2500 MHz WLAN applications. It requires 10 passive 0402 SMD components and can provide 20.5 dB gain at 2400 MHz. The noise figure varies from 1.05 dB to 1.0 dB (SMA and PCB losses are subtracted) over the frequency band.

The circuit achieves an input return loss of 11 dB and output return loss 14 dB. Furthermore, the circuit is unconditionally stable from 10 MHz to 15 GHz. However, Proper RF grounding on PCB has to be ensured in order to achieve stability k -factor > 1 (Figure 20).

At 2400 MHz, using two tones spacing of 1 MHz, the output third order intercept point OIP3 reaches 13 dBm. Besides, we obtain input 1dB input compression point IP1dB of -16.2 dBm at 2400 MHz.

3.2 Performance overview

Device: BFP840FESD

Application: Low Noise Amplifier for 2.4 - 2.5 GHz WLAN

PCB Marking: BFP840FESD TSFP-4-1 **M13031106**

Table 1 Summary of Measurement Results

| Parameter | Symbol | Value | | Unit | Note/Test Condition |
|--------------------|-------------------|-------|-------|------|--|
| DC Voltage | V_{CC} | 3.0 | | V | |
| DC Current | I_{CC} | 14.1 | | mA | |
| Frequency Range | Freq | 2400 | 2500 | MHz | |
| Gain (ON-Mode) | G_{ON} | 20.6 | 20.3 | dB | |
| Gain (OFF-Mode) | G_{OFF} | -27.3 | -26.9 | dB | |
| Noise Figure | NF | 1.05 | 1.0 | dB | SMA and PCB losses (~0.05 dB) are subtracted |
| Input Return Loss | RL_{in} | 11.3 | 11.6 | dB | |
| Output Return Loss | RL_{out} | 14 | 14.6 | dB | |
| Reverse Isolation | IR _{rev} | 26.3 | 26 | dB | |
| Input P1dB | IP1dB | -16.2 | -15.8 | dBm | |
| Output P1dB | OP1dB | 3.4 | 3.5 | dBm | |
| Input IP3 | IIP3 | -7.2 | -7.3 | dBm | |
| Output IP3 | OIP3 | 13.4 | 13 | dBm | Power @ Input: -30 dBm |
| Stability | k | > 1.0 | | -- | Stability measured from 10MHz to 15GHz |

3.3 Schematics

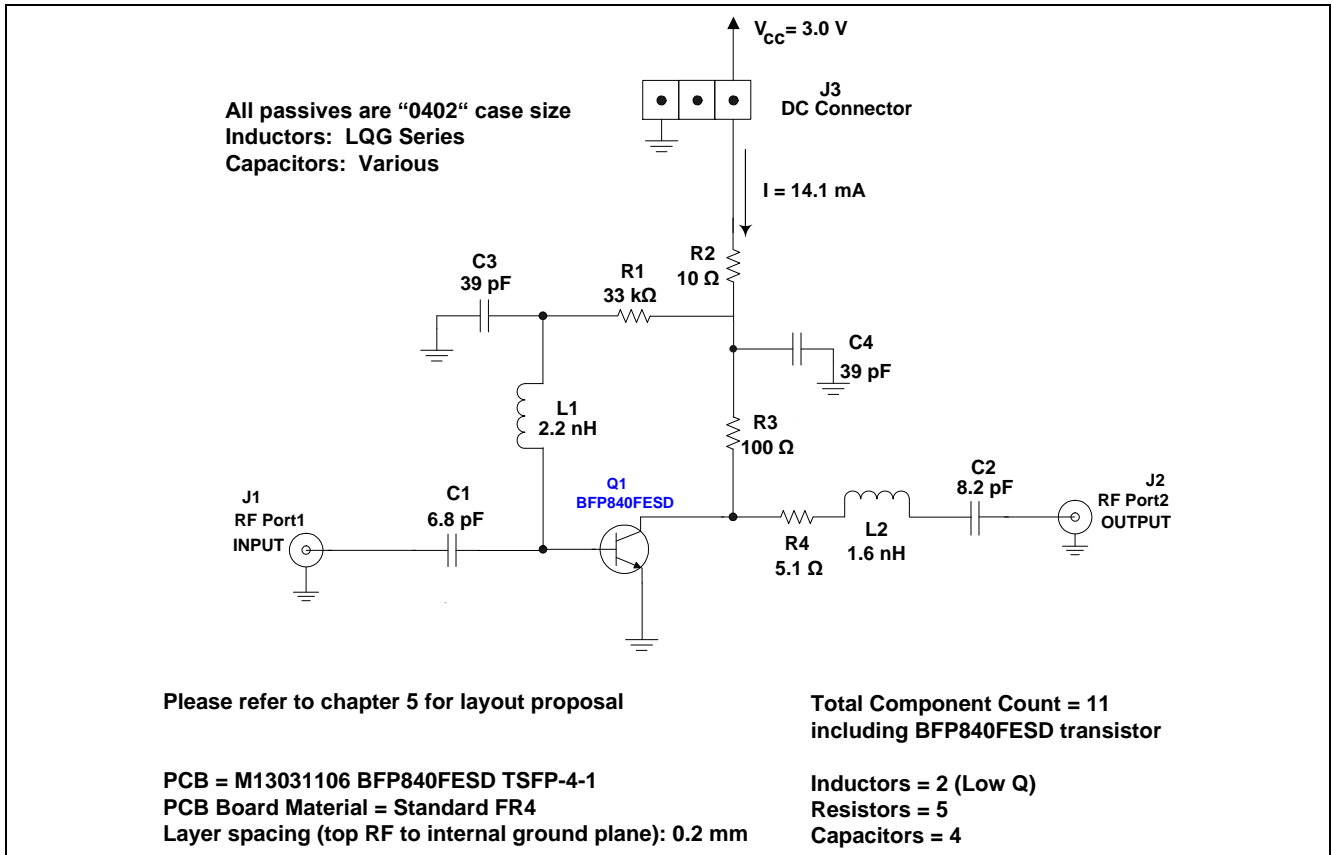

Figure 4 Schematic Diagram of the used Circuit

Table 2 Bill-of-Materials

| Symbol | Value | Unit | Size | Manufacturer | Comment |
|--------|-------|------|----------|-----------------------|--|
| C1 | 6.8 | pF | 0402 | Various | Input DC block & input matching |
| C2 | 8.2 | pF | 0402 | Various | Output DC block & output matching |
| C3 | 39 | pF | 0402 | Various | RF decoupling |
| C4 | 39 | pF | 0402 | Various | RF decoupling |
| L1 | 2.2 | nH | 0402 | LQG | Input matching |
| L2 | 1.6 | nH | 0402 | LQG | Output matching and high frequency stability improvement |
| R1 | 33 | kΩ | 0402 | Various | DC biasing |
| R2 | 10 | Ω | 0402 | Various | DC biasing (provides DC negative feedback to stabilize DC operating point over temperature variation, transistor h_{FE} variation, etc.) |
| R3 | 100 | Ω | 0402 | Various | Stability improvement & input/output matching |
| R4 | 5.1 | Ω | 0402 | Various | stability improvement |
| Q1 | | | TSFP-4-1 | Infineon Technologies | BFP840FESD SiGe:C Heterojunction Bipolar RF Transistor |

4 Measured Graphs

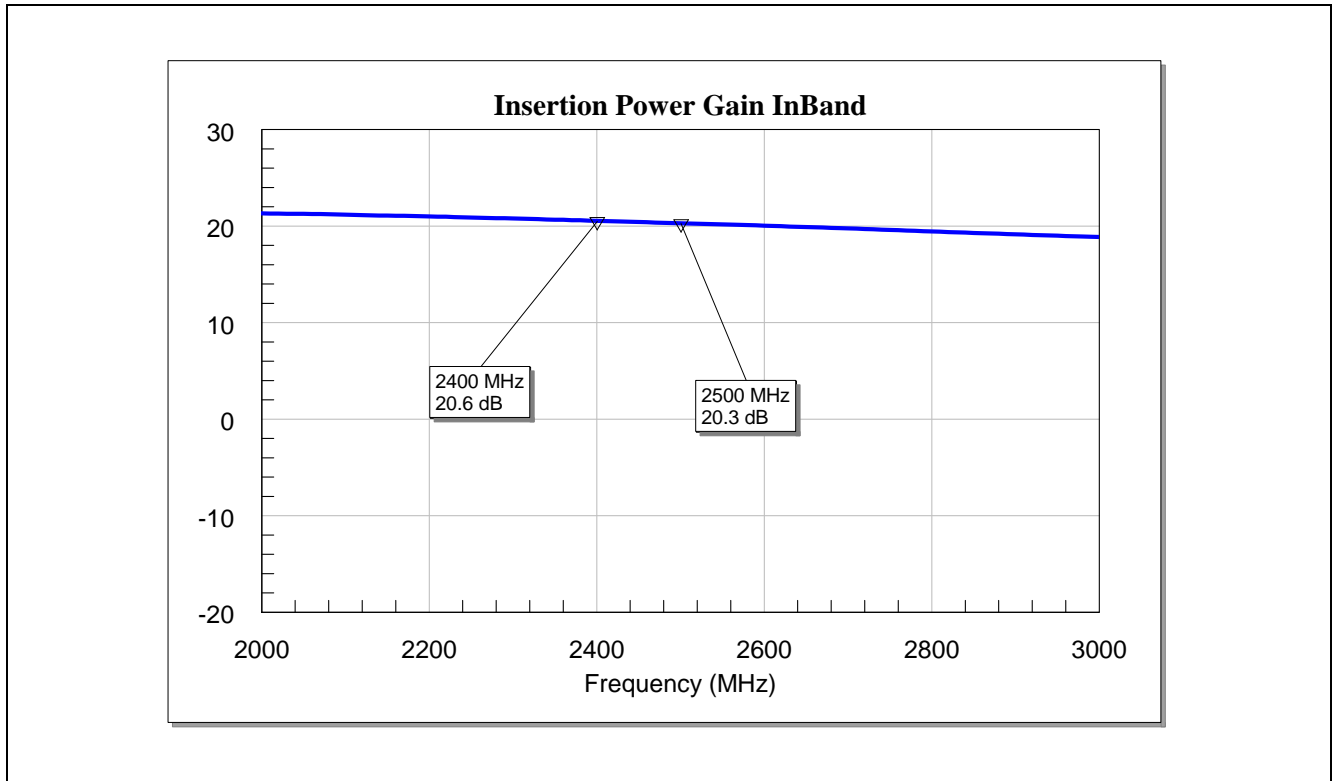

Figure 5 Insertion Power Gain of the 2.4 – 2.5 GHz WLAN LNA with BFP840FESD

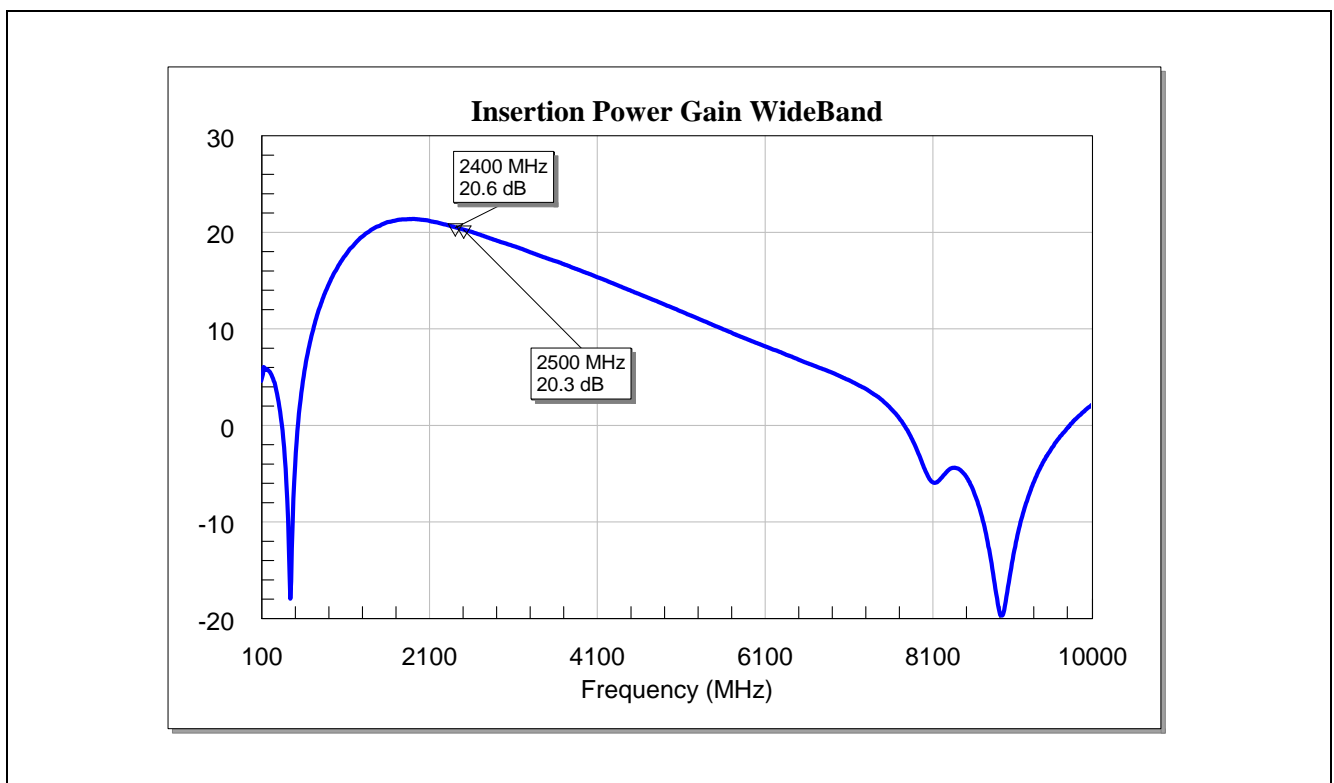

Figure 6 Wideband Insertion Power Gain of the 2.4 – 2.5 GHz WLAN LNA with BFP840FESD

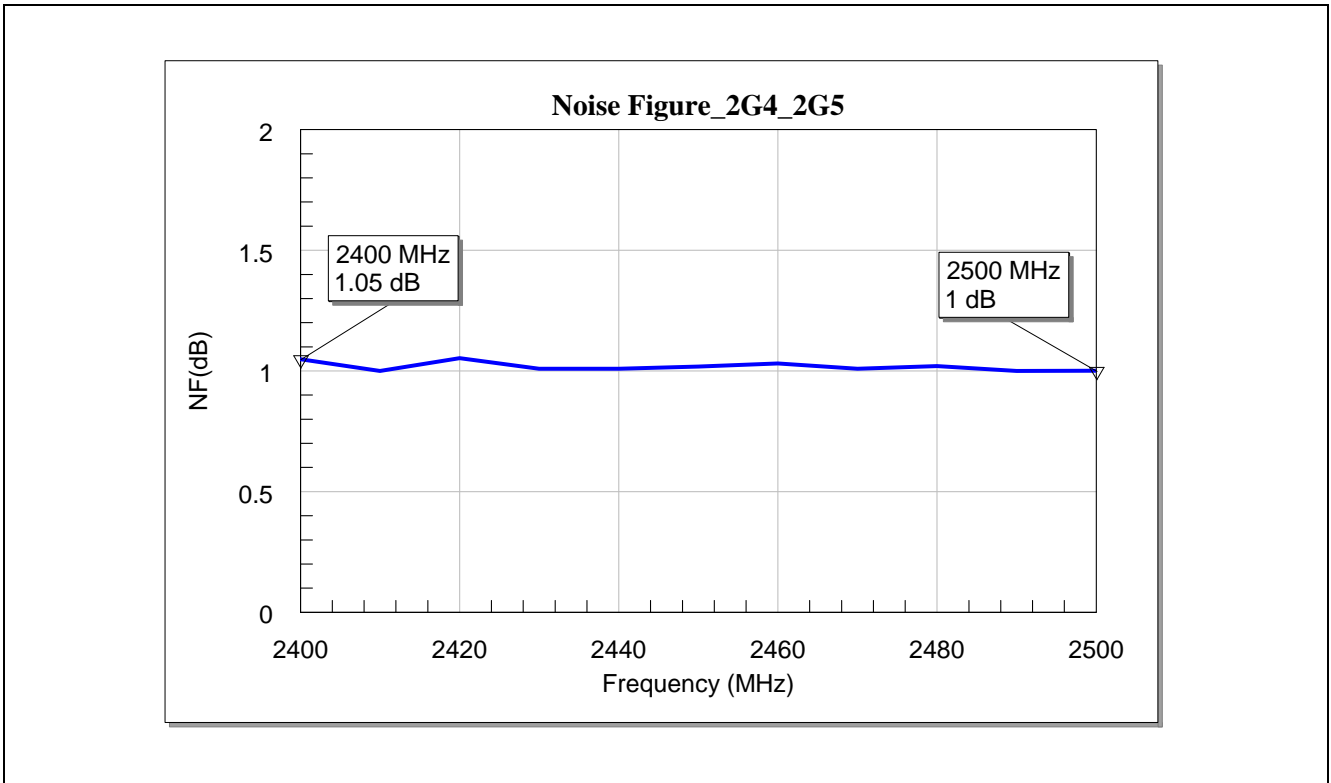

Figure 7 Noise Figure of BFP840FESD LNA for 2400 - 2500 MHz

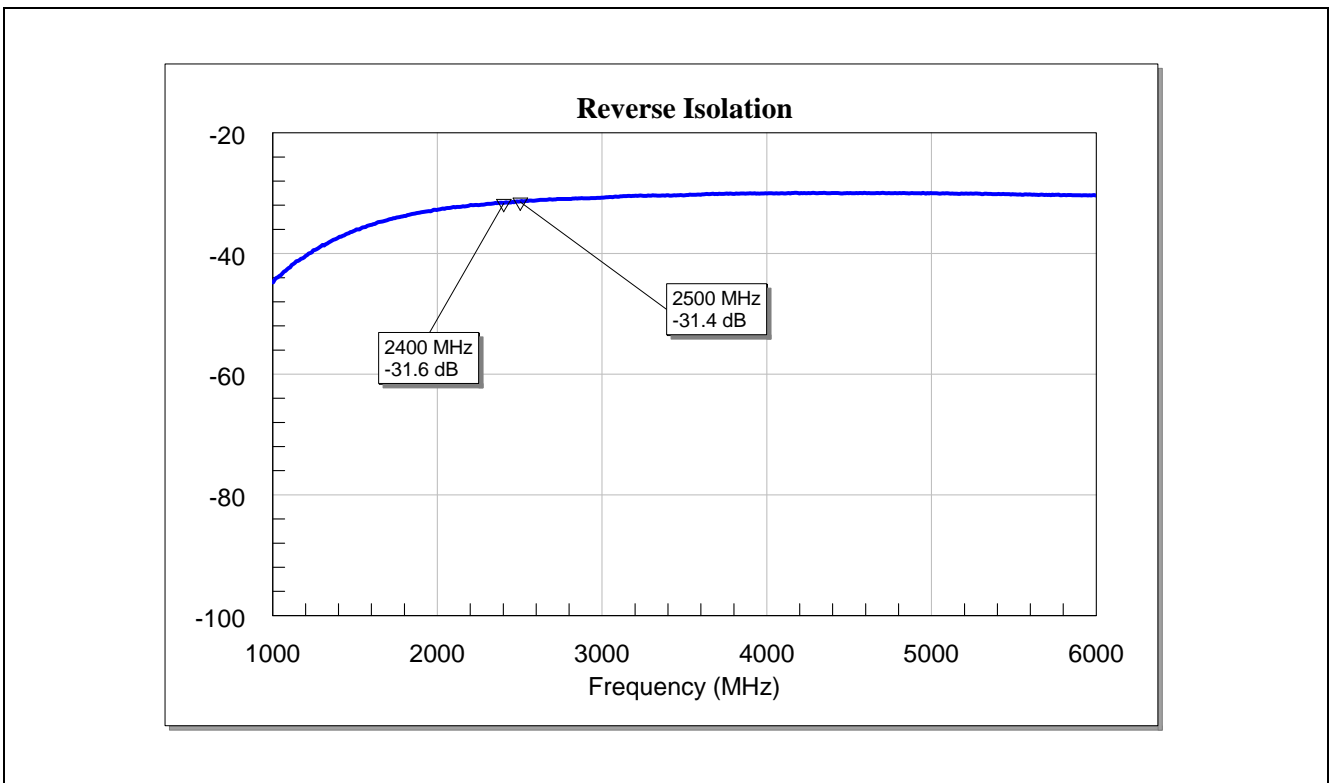

Figure 8 Reverse Isolation of the 2.4 – 2.5 GHz WLAN LNA with BFP840FESD

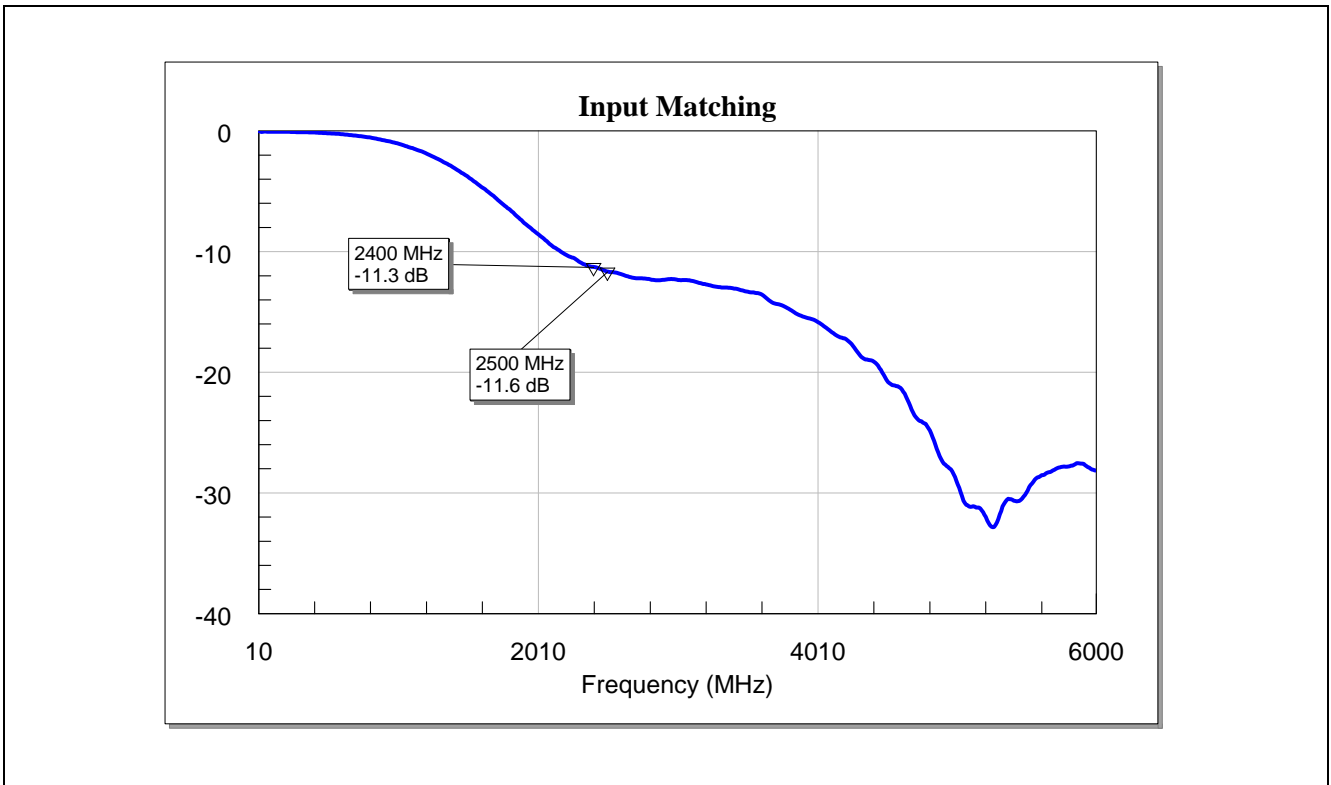

Figure 9 Input Matching of the 2.4 – 2.5 GHz WLAN LNA with BFP840FESD

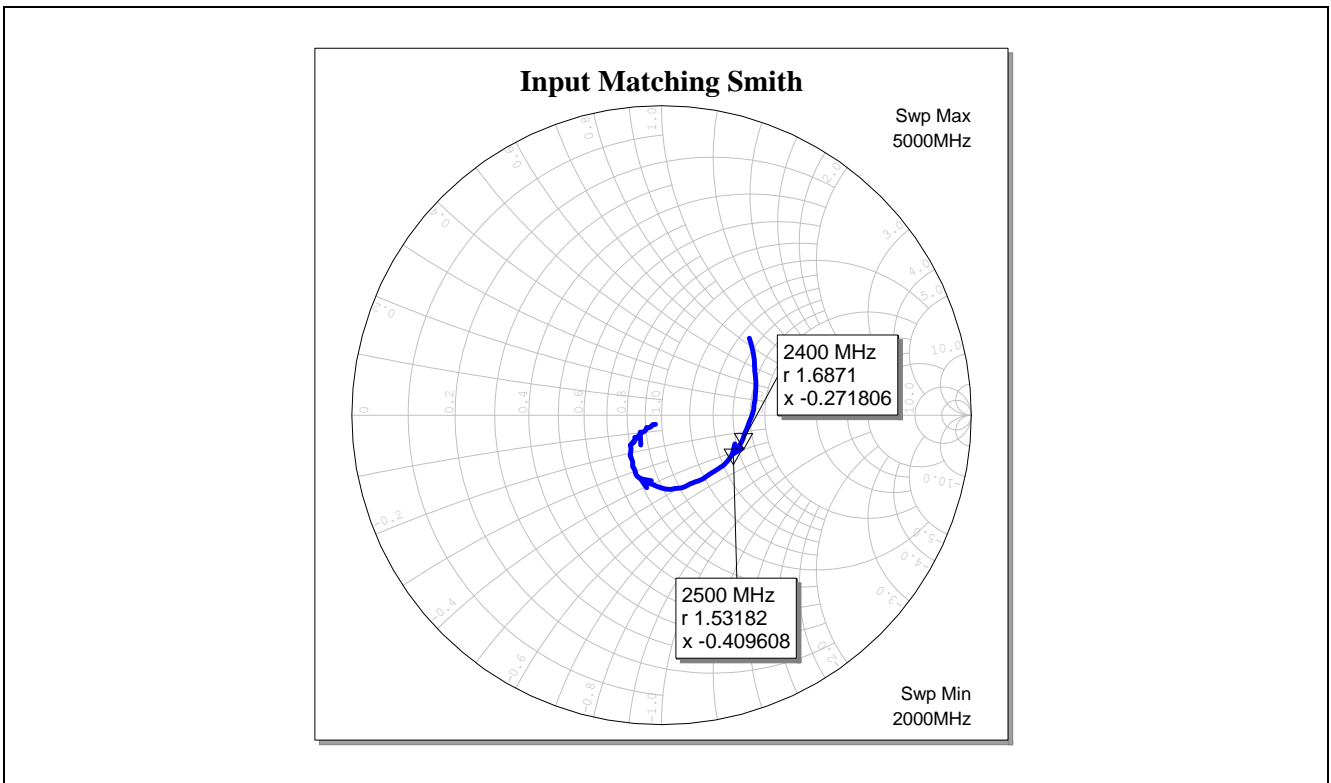

Figure 10 Input Matching of the 2.4 – 2.5 GHz WLAN LNA with BFP840FESD (Smith Chart)

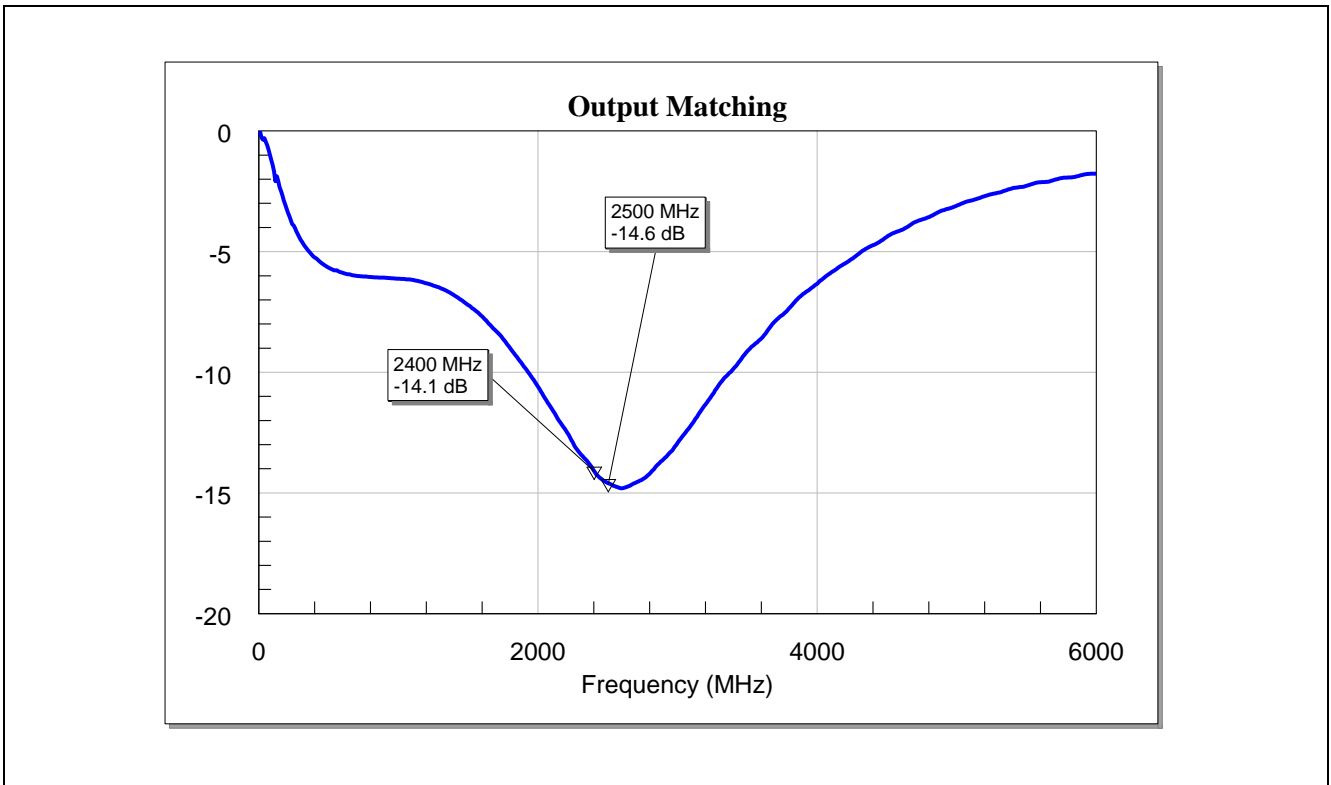

Figure 11 Output Matching of the 2.4 – 2.5 GHz WLAN LNA with BFP840FESD

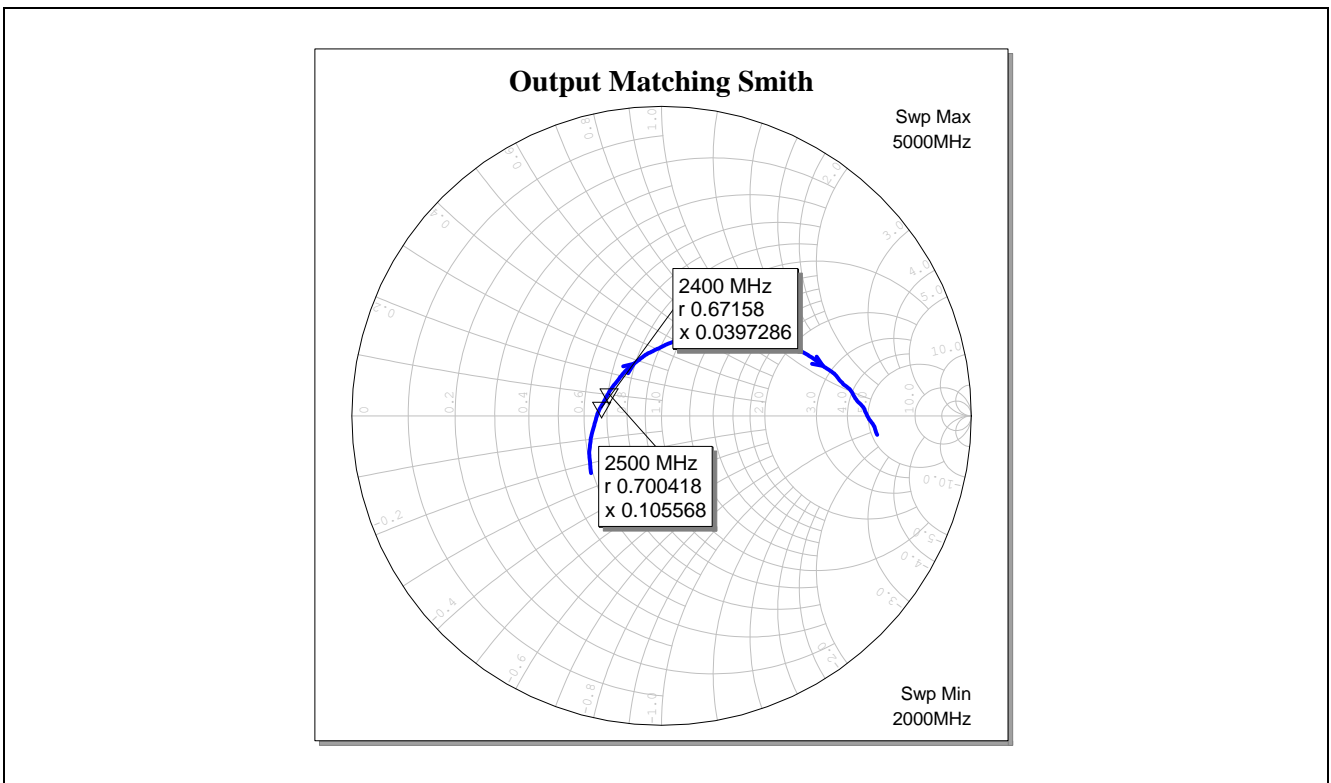

Figure 12 Output Matching of the 2.4 – 2.5 GHz WLAN LNA with BFP840FESD (Smith Chart)

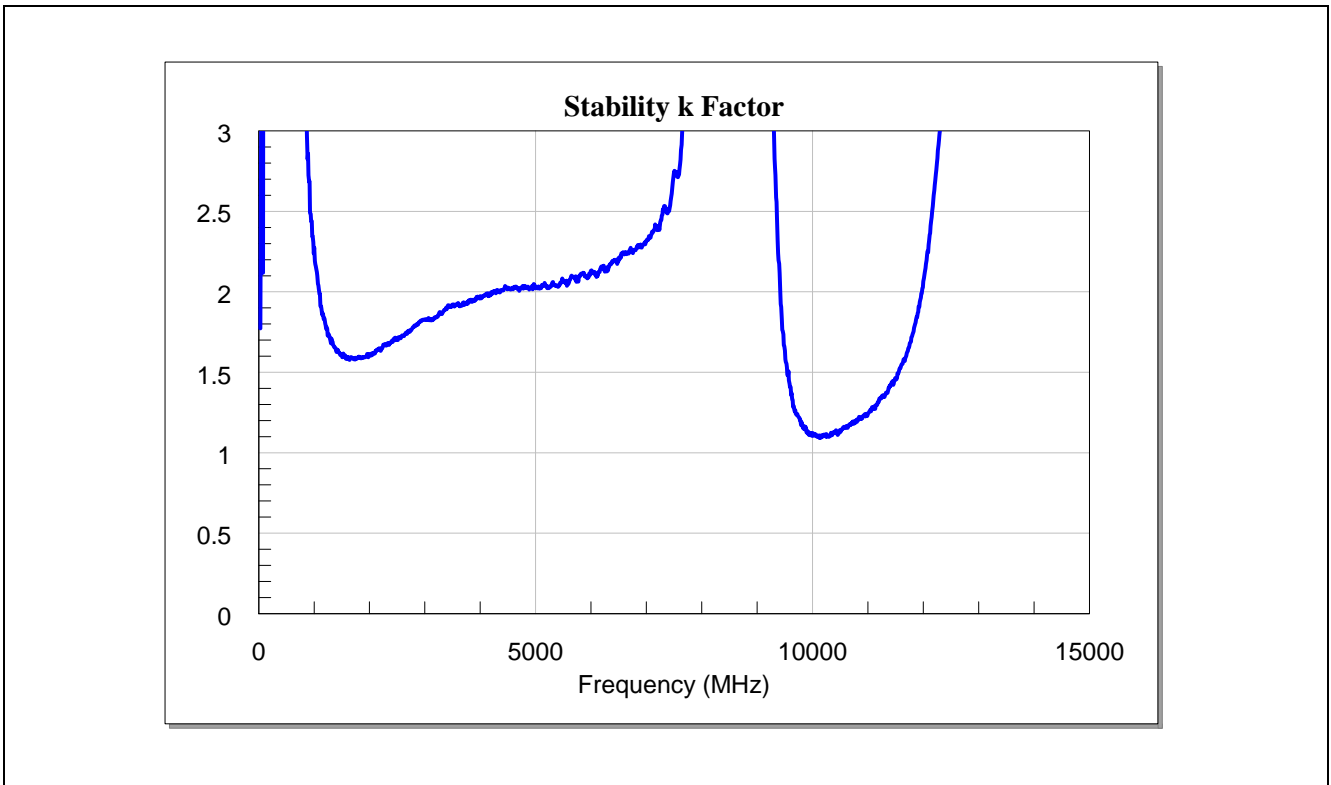

Figure 13 Wideband Stability k Factor of the 2.4 – 2.5 GHz WLAN LNA with BFP840FESD

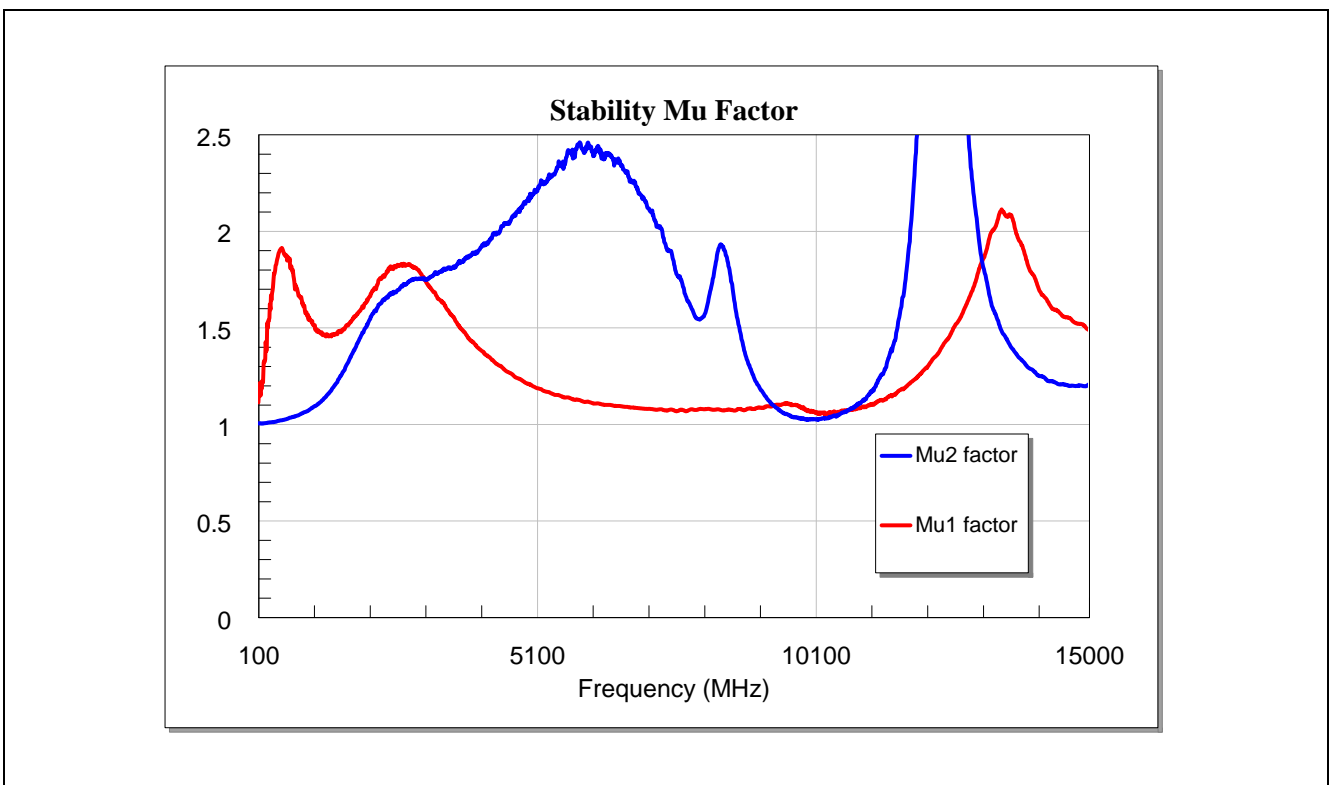

Figure 14 Wideband Stability Mu Factor of the 2.4 – 2.5 GHz WLAN LNA with BFP840FESD

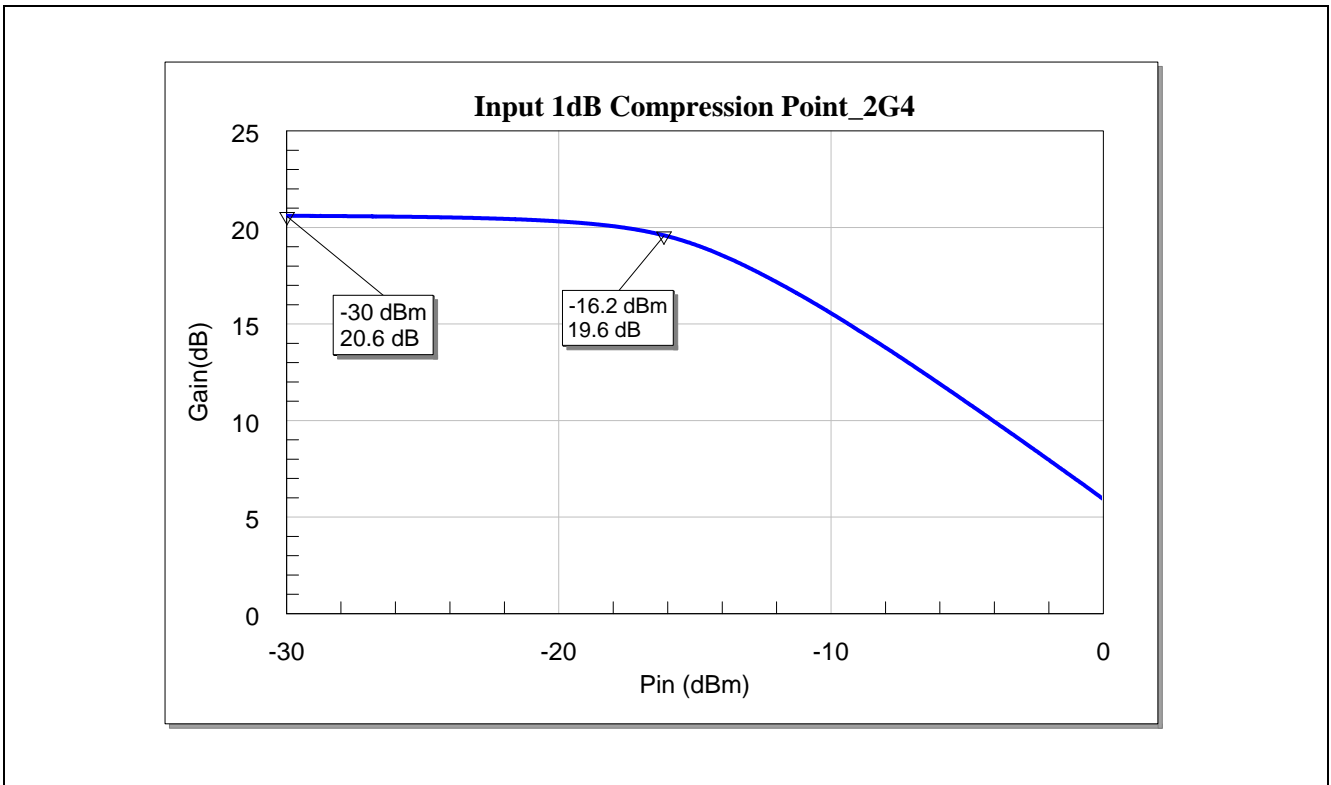

Figure 15 Input 1dB Compression Point of the BFP840FESD Circuit at 2400 MHz

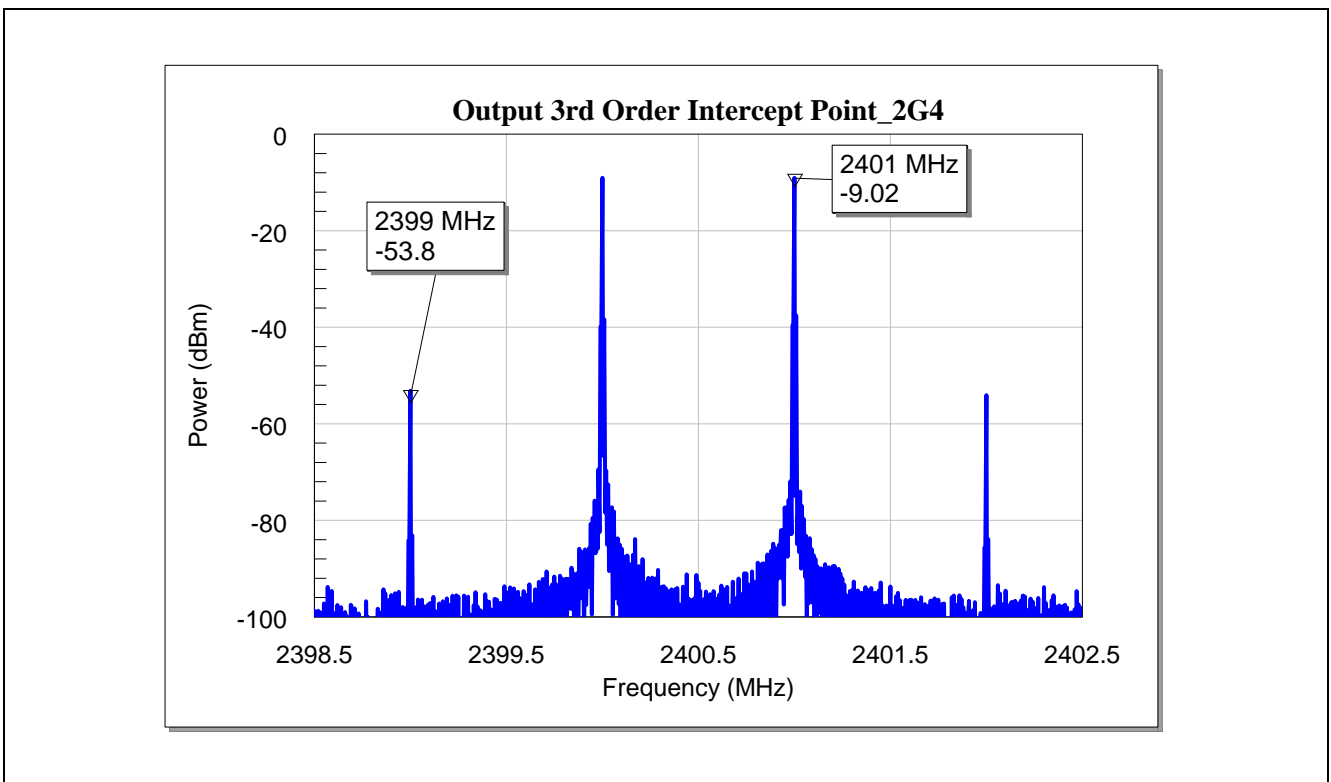

Figure 16 Output 3rd Order Intercept Point of BFP840FESD at 2400 MHz

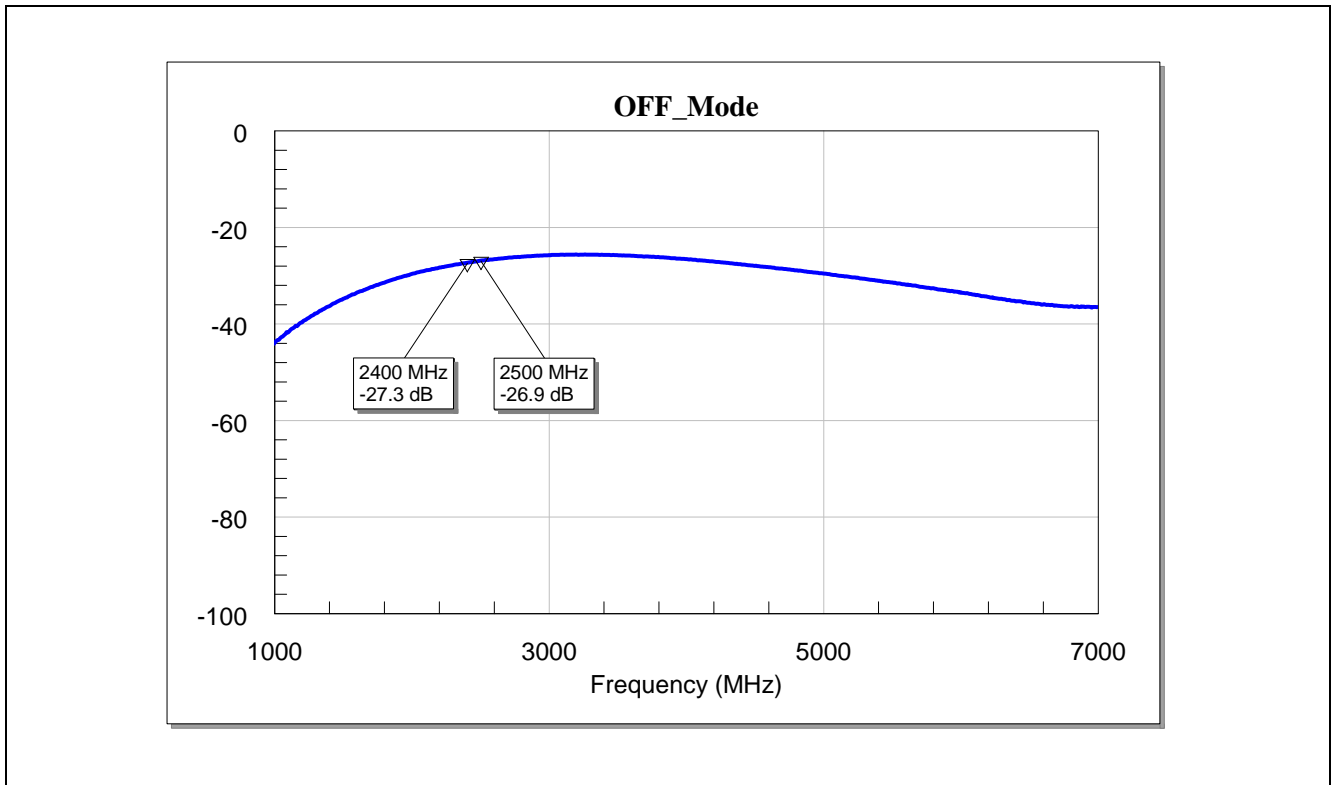

Figure 17 OFF-Mode ($V_{cc} = 0V$, $I_{cc} = 0mA$) S₂₁ of the 2.4 – 2.5 GHz WLAN LNA with BFP840FESD

5 Evaluation Board and Layout Information

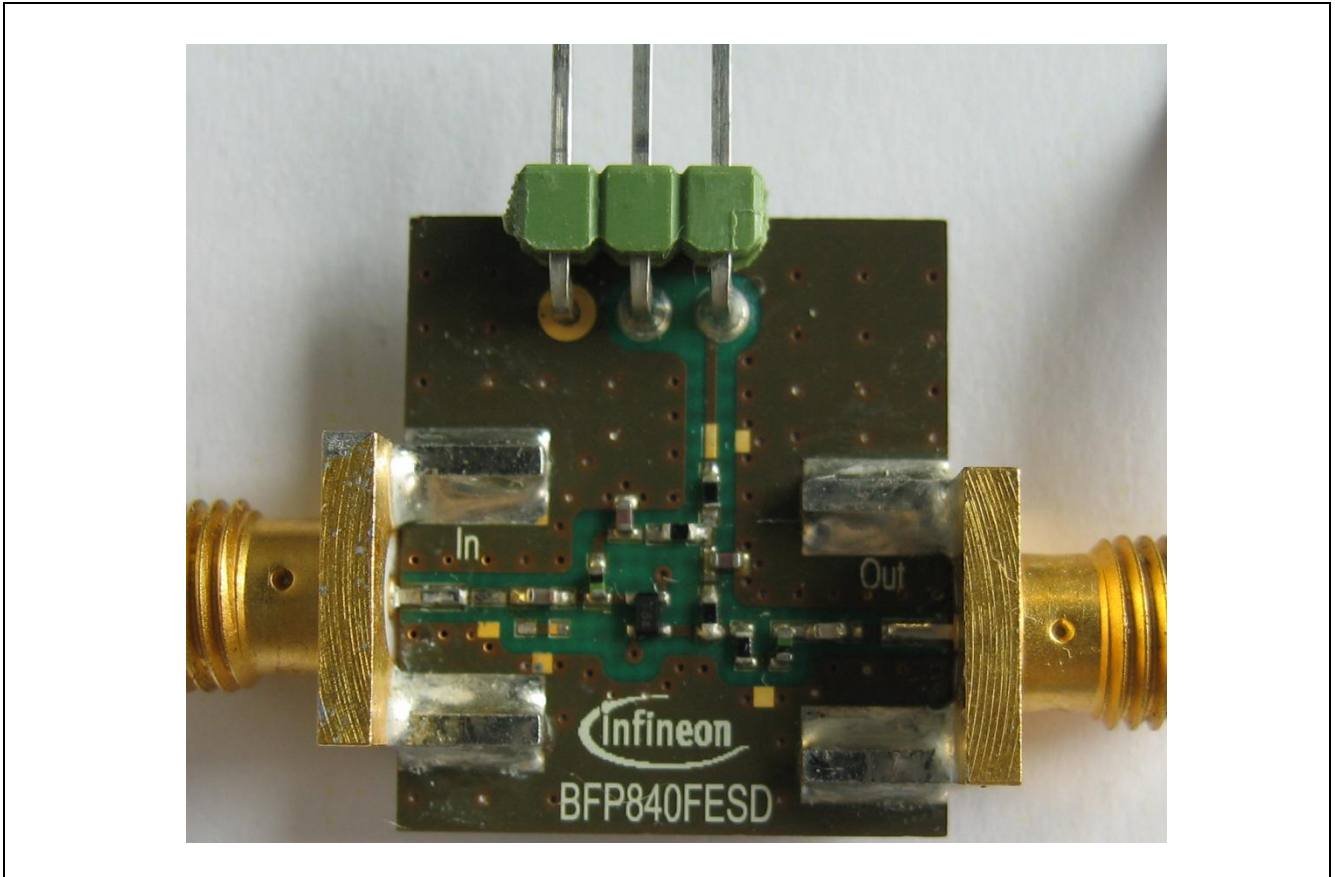

Figure 18 Photo of the BFP840FESD 2.4 – 2.5 GHz WLAN LNA Evaluation Board

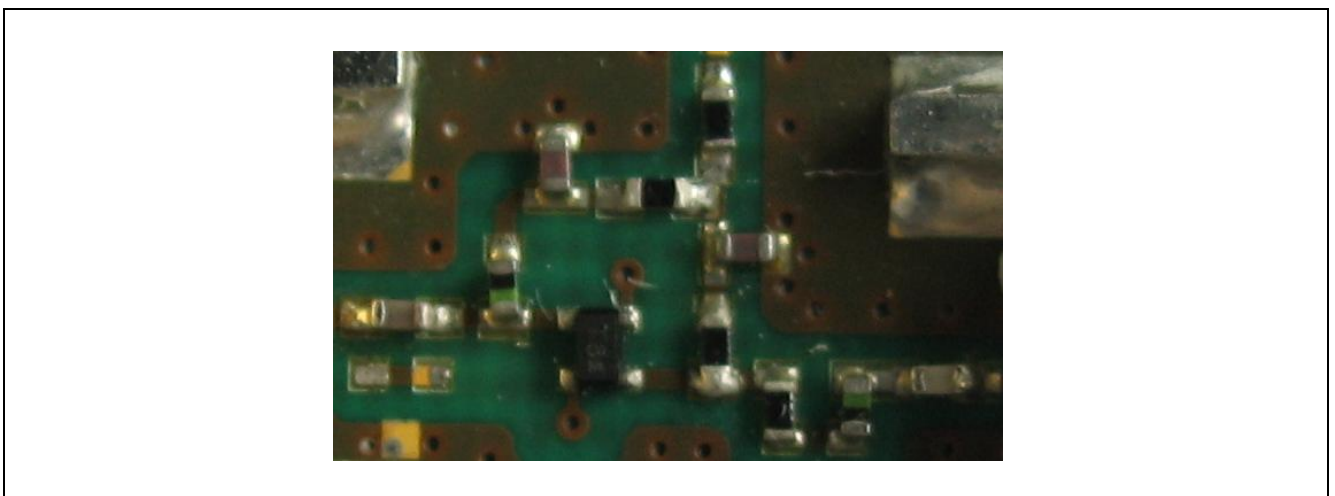

Figure 19 Zoom-In Picture of the BFP840FESD 2.4 – 2.5 GHz WLAN LNA Evaluation Board

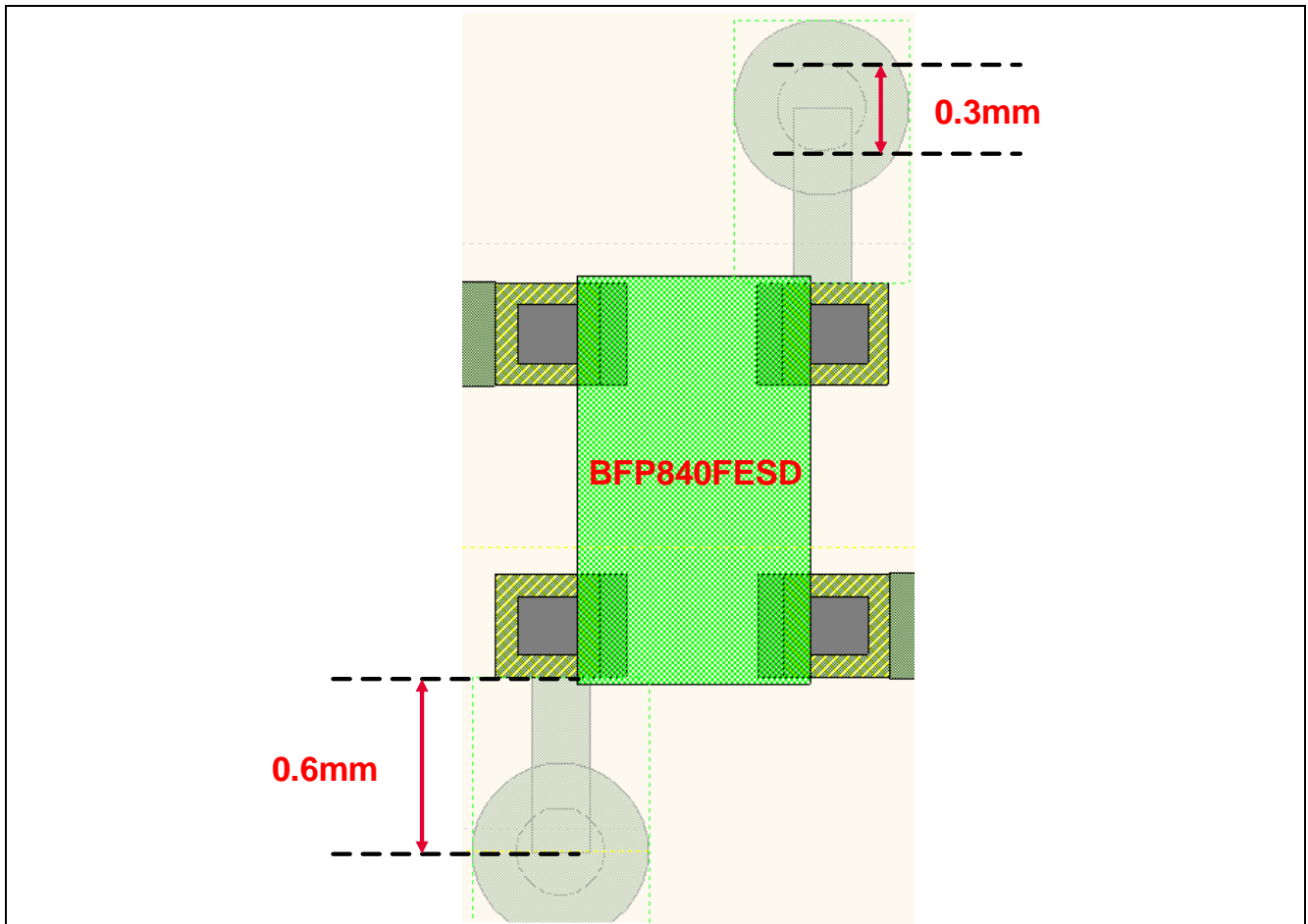

Figure 20 Layout Proposal for RF Grounding of the 2.4 – 2.5 GHz WLAN LNA with BFP840FESD

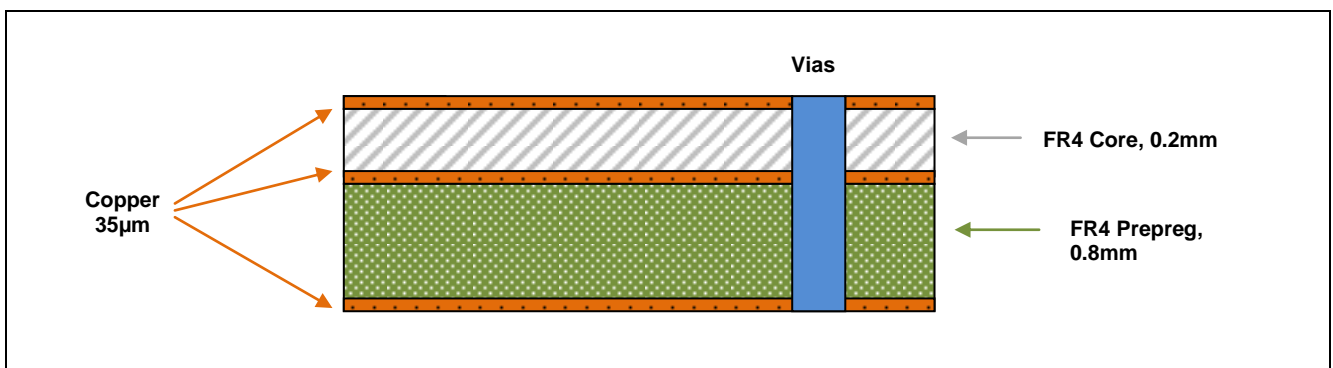

Figure 21 PCB Layer Information

6 Authors

Xi Chen, Internship Student of Application Engineering of Business Unit “RF and Protection Devices”

Shamsuddin Ahmed, Application Engineer of Business Unit “RF and Protection Devices”

7 Remark

The graphs are generated with the simulation program AWR Microwave Office®.

www.infineon.com