

BFR840L3RHESD

**BFR840L3RHESD SiGe:C Ultra Low
Noise RF Transistor in Low Parts Count
Wideband / Dual Band 2.4 – 5.8 GHz
WLAN LNA Application**

'0201' case size passives

< 1 microsecond Turn-On / Turn-Off Time

18.5 dB Gain, 1.1 dB Noise Figure at 2.4 GHz;

14.1 dB Gain, 1.4 dB Noise Figure at 5.8 GHz

(For 802.11a / ac / b / g / n Wireless LAN Applications)

Application Note AN292

Revision: Rev. 1.0

2012-08-14

Edition 2012-08-14

**Published by
Infineon Technologies AG
81726 Munich, Germany**

**© 2012 Infineon Technologies AG
All Rights Reserved.**

Legal Disclaimer

The information given in this document shall in no event be regarded as a guarantee of conditions or characteristics. With respect to any examples or hints given herein, any typical values stated herein and/or any information regarding the application of the device, Infineon Technologies hereby disclaims any and all warranties and liabilities of any kind, including without limitation, warranties of non-infringement of intellectual property rights of any third party.

Information

For further information on technology, delivery terms and conditions and prices, please contact the nearest Infineon Technologies Office (www.infineon.com).

Warnings

Due to technical requirements, components may contain dangerous substances. For information on the types in question, please contact the nearest Infineon Technologies Office.

Infineon Technologies components may be used in life-support devices or systems only with the express written approval of Infineon Technologies, if a failure of such components can reasonably be expected to cause the failure of that life-support device or system or to affect the safety or effectiveness of that device or system. Life support devices or systems are intended to be implanted in the human body or to support and/or maintain and sustain and/or protect human life. If they fail, it is reasonable to assume that the health of the user or other persons may be endangered.

Application Note AN292**Revision History: 2012-08-14****Previous Revision: No previous revision**

Page	Subjects (major changes since last revision)

Trademarks of Infineon Technologies AG

AURIX™, C166™, CanPAK™, CIPOS™, CIPURSE™, EconoPACK™, CoolMOS™, CoolSET™, CORECONTROL™, CROSSAVE™, DAVE™, DI-POL™, EasyPIM™, EconoBRIDGE™, EconoDUAL™, EconoPIM™, EconoPACK™, EiceDRIVER™, eupec™, FCOS™, HITFET™, HybridPACK™, I²RF™, ISOFACE™, IsoPACK™, MIPAQ™, ModSTACK™, my-d™, NovalithIC™, OptiMOS™, ORIGA™, POWERCODE™, PRIMARION™, PrimePACK™, PrimeSTACK™, PRO-SIL™, PROFET™, RASIC™, ReverSave™, SatRIC™, SIEGET™, SINDRION™, SIPMOS™, SmartLEWIS™, SOLID FLASH™, TEMPFET™, thinQ!™, TRENCHSTOP™, TriCore™.

Other Trademarks

Advance Design System™ (ADS) of Agilent Technologies, AMBA™, ARM™, MULTI-ICE™, KEIL™, PRIMECELL™, REALVIEW™, THUMB™, µVision™ of ARM Limited, UK. AUTOSAR™ is licensed by AUTOSAR development partnership. Bluetooth™ of Bluetooth SIG Inc. CAT-ig™ of DECT Forum. COLOSSUS™, FirstGPS™ of Trimble Navigation Ltd. EMV™ of EMVCo, LLC (Visa Holdings Inc.). EPCOS™ of Epcos AG. FLEXGO™ of Microsoft Corporation. FlexRay™ is licensed by FlexRay Consortium. HYPERTERMINAL™ of Hilgraeve Incorporated. IEC™ of Commission Electrotechnique Internationale. IrDA™ of Infrared Data Association Corporation. ISO™ of INTERNATIONAL ORGANIZATION FOR STANDARDIZATION. MATLAB™ of MathWorks, Inc. MAXIM™ of Maxim Integrated Products, Inc. MICROTEC™, NUCLEUS™ of Mentor Graphics Corporation. MIPI™ of MIPI Alliance, Inc. MIPS™ of MIPS Technologies, Inc., USA. muRata™ of MURATA MANUFACTURING CO., MICROWAVE OFFICE™ (MWO) of Applied Wave Research Inc., OmniVision™ of OmniVision Technologies, Inc. Openwave™ Openwave Systems Inc. RED HAT™ Red Hat, Inc. RFMD™ RF Micro Devices, Inc. SIRIUS™ of Sirius Satellite Radio Inc. SOLARIS™ of Sun Microsystems, Inc. SPANSION™ of Spansion LLC Ltd. Symbian™ of Symbian Software Limited. TAIYO YUDEN™ of Taiyo Yuden Co. TEAKLITE™ of CEVA, Inc. TEKTRONIX™ of Tektronix Inc. TOKO™ of TOKO KABUSHIKI KAISHA TA. UNIX™ of X/Open Company Limited. VERILOG™, PALLADIUM™ of Cadence Design Systems, Inc. VLYNQ™ of Texas Instruments Incorporated. VXWORKS™, WIND RIVER™ of WIND RIVER SYSTEMS, INC. ZETEX™ of Diodes Zetex Limited.

Last Trademarks Update 2011-11-11

Table of Contents

1	Introduction	5
3	Schematic	7
2	Measured Graphs	9
3	Evaluation Board and Layout Information	27
4	Author	29
5	Remark	29

List of Figures

Figure 1	Block Diagram of low-cost WLAN application with Dual Band LNA	6
Figure 2	Schematic Diagram	7
Figure 3	Noise Figure, 2.4 – 6 GHz Wideband / Dual Band LNA	9
Figure 4	Noise Figure, Tabular Data	10
Figure 5	Amplifier Gain compression at 2400 MHz	11
Figure 6	Amplifier Gain Compression at 5825 MHz	12
Figure 7	Amplifier stability factor “ $\mu 1$ ”	13
Figure 8	Input Match of Broadband / Dual Band LNA	14
Figure 9	Input Matching of the Broadband / Dual Band LNA, Smith Chart	15
Figure 10	Wideband Gain of Amplifier, DC Power ON	16
Figure 11	Wideband Gain of Amplifier, DC POWER OFF	17
Figure 12	Reverse Isolation, DC power ON	18
Figure 13	Reverse Isolation, DC Power OFF	19
Figure 14	Amplifier Wideband Output Return Loss	20
Figure 15	Amplifier Output Return Loss, Smith Chart	21
Figure 16	Amplifier Input 3 rd Order Intercept Point Measurement, 2400 MHz	22
Figure 17	Amplifier Input 3 rd Order Intercept Point Measurement, 5825 MHz	23
Figure 18	Diagram of setup for making amplifier turn-on and turn-off times	24
Figure 19	Oscilloscope screen shot, amplifier turn-on time	25
Figure 20	Oscilloscope screen-shot, amplifier turn-off time	26
Figure 21	View of Entire PC Board	27
Figure 22	Close-In View of LNA Section.	28
Figure 23	PC Board Cross-Section Information	29

List of Tables

Table 1	Summary of Measurement Results	6
Table 2	Bill-of-Materials	7

1 Introduction

1.1 Device Overview: BFR840L3RHESD

Infineon Technologies' **BFR840L3RHESD** is a high gain, ultra low noise Silicon-Germanium-Carbon (SiGe:C) HBT device suitable for a wide range of Low Noise Amplifier (LNA) applications. This RF Transistor has integrated protection structures to guard against Electro Static Discharge (ESD) events up to 1.5kV per the Human Body Model (HBM), and these same structures also protect the transistor against damage caused by excessive RF input power levels up to +20 dBm. The device is housed in the RoHS-compliant, Halogen-free TSLP-3-9 leadless package, which is only 1.0 x 0.6 x 0.31mm. The 0.31mm package height makes this transistor a good choice for RF Module applications.

1.2 Circuitry

The circuit shown is targeted for Wireless LAN (WLAN) 802.11a / ac / b / g / n applications where lowest possible cost, low external parts count, and high receiver sensitivity / long range are primary goals. "0201" case size passives are used throughout. Resistive Feedback is used to achieve unconditional stability and a good broadband 50 ohm match at both input and output. Feedback also makes the amplifier more tolerant of component & device variation, as well as making the design more forgiving of variations in PC board layout. The price paid for using feedback is a slight increase in amplifier noise figure, as well as some decrease in gain. (The penalty paid in Noise Figure from the feedback is approximately 0.4 dB at 2.4 GHz, and ~0.3 dB at 5 – 6 GHz). The LNA may be used as either a single-band amplifier at 2.4 or at 5 – 6 GHz with no changes made to the element values, or the LNA may be used in a dualband configuration where both WLAN bands are amplified together in a single device, i.e. for legacy systems where Dual Band Dual Concurrent operation is not required (refer to **Figure 1**). This simplification and commonality allows the end user to use one LNA design across his or her different systems, at either WLAN frequency band, simplifying logistics and reducing design effort. Potential applications may include WLAN transceivers used in Access Points, laptop PCs, Tablets, Gaming Consoles, USB dongles, etc. Generally, LNA's for these applications must be able to switch on & off within about 1 microsecond or less. The charge storage (capacitance) used in this circuit is

minimized to reduce on / off times, and this LNA achieves a switching time of ~ 15 nanoseconds. One potential trade-off for reduced capacitance values is a reduction in Third Order Intercept (IP₃) performance. The good wideband match of the LNA – with an input and output return loss of -10 dB or better across the entire 2.4 – 6 GHz frequency range - makes integrating the amplifier with other system blocks (filters, switches, diplexers, etc.) faster, easier and more predictable, reducing risk and time-to-market. No external emitter degeneration is required. The LNA is unconditionally stable over the 50 MHz – 12 GHz frequency range. External parts count (not including BFR840L3RHESD transistor) is 8; 4 capacitors, 3 resistors, and 1 chip inductors. All passives are ‘0201’ case size. At 2.4 GHz, the amplifier achieves ~ 18 dB gain with a Noise Figure of 1.1 dB, while at 5.8 GHz, the gain is ~ 14 dB with a Noise Figure of 1.4 dB.

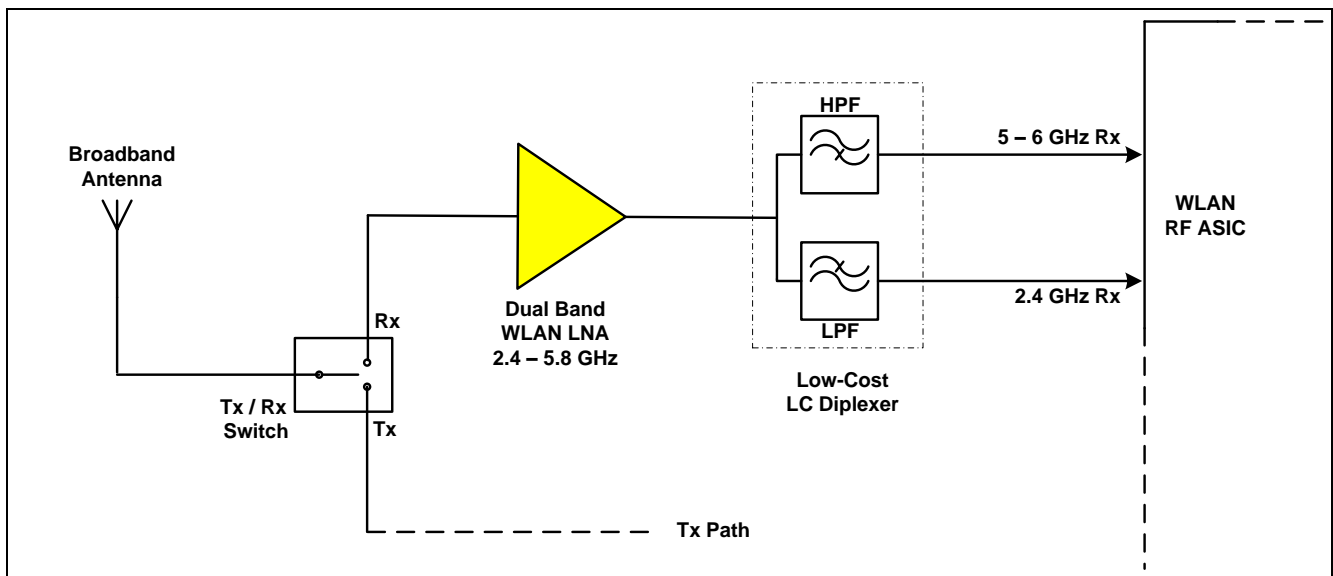

Figure 1 Block Diagram of low-cost WLAN application with Dual Band LNA

Table 1 Summary of Measurement Results

(T=25 °C, network analyzer source power ≈ -25 dBm, V_{CC} = 3.0 V, V_{CE} = 1.87 V, I_C=9.4 mA, Z_S=Z_L=50 Ω)

Frequency MHz	dB[s11] ²	DC ON dB[s21] ²	DC OFF dB[s21] ²	Δ dB[s21] ² ON→ OFF	dB[s12] ²	dB[s22] ²	* NF dB	IIP ₃ dBm	OIP ₃ dBm	IP _{1dB} dBm	OP _{1dB} dBm
2400	-12.8	18.5	-19.2	~ - 38	-24.1	-11.1	1.1	-5.5	+13.0	-15.6	+1.9
2483.5	-12.7	18.4	-19.2	---	-24.1	-11.0	1.1	---	---	---	---
4900	-11.9	15.0	-19.2	---	-22.3	-12.5	1.4	---	---	---	---
5825	-13.0	14.1	-20.1	~ - 34	-21.4	-12.7	1.4	+0.3	+14.4	-12.6	+0.5

* Does not extract PCB loss. If PCB loss (at input) were extracted, noise figure would be ~ 0.1 dB lower @ 2.4 GHz, ~ 0.2 dB lower @ 5.8 GHz.

Turn-On Time: ~ 15 nanoseconds; Turn-Off Time ~ 15 nanoseconds.

Note: reverse isolation (dB[s12]²) when DC power to LNA is OFF = -15.8 dB @ 2.4 GHz, -14.7 dB @ 5.825 GHz

3 Schematic Diagram

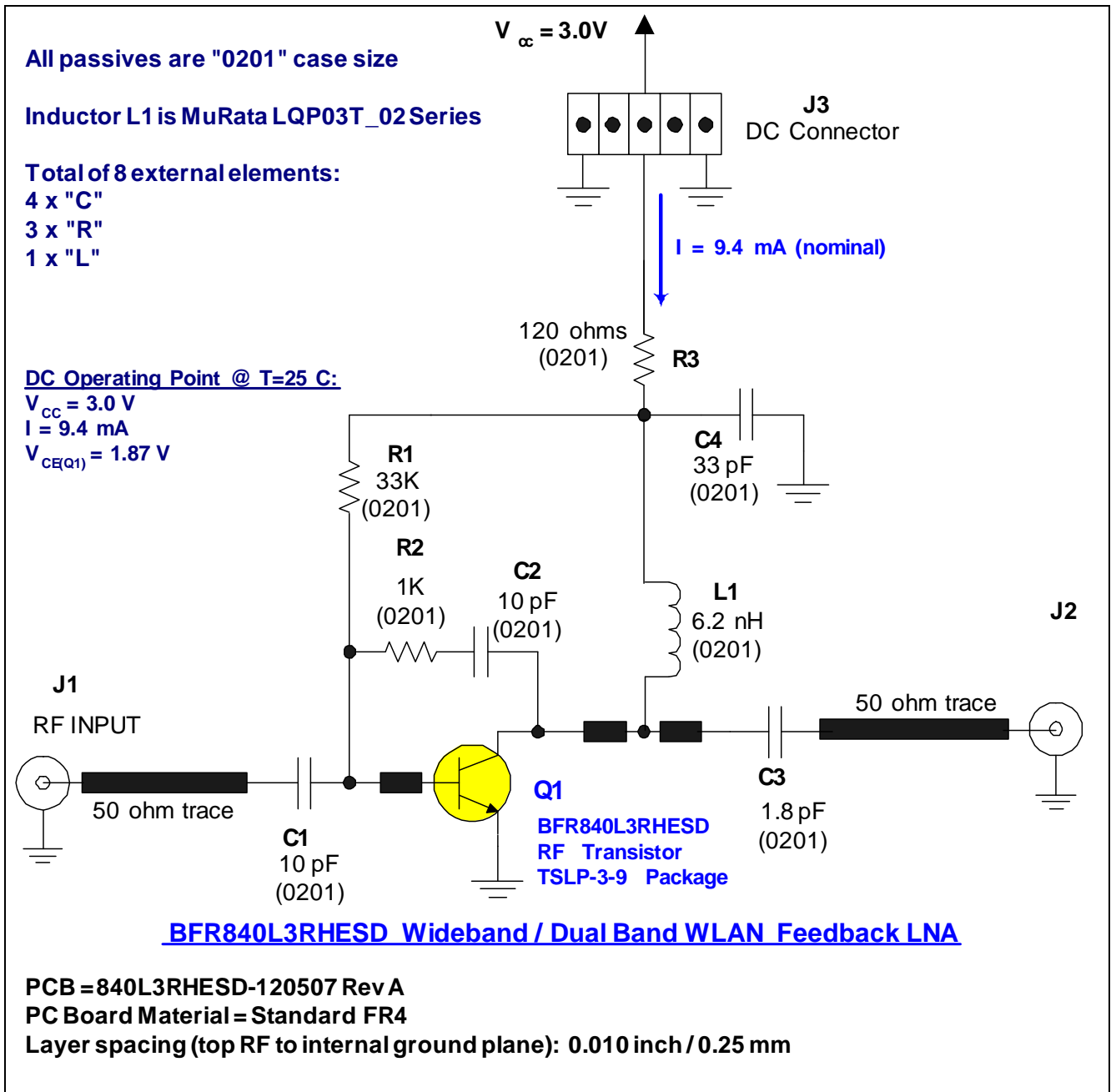

Figure 2 Schematic Diagram

Table 2 Bill-of-Materials

Symbol	Value	Unit	Size	Manufacturer	Comment
C1	10	pF	0201	Various	Input DC block
C2	10	pF	0201	Various	DC block for RF Feedback path
C3	1.8	pF	0201	Various	Output DC block; also influences input and output matching

Table 2 Bill-of-Materials

Symbol	Value	Unit	Size	Manufacturer	Comment
C4	33	pF	0201	Various	RF decoupling / lower frequency decoupling / blocking cap. Strongest influence on Turn-On / Turn-Off time. Value was minimized to speed up ON-OFF and OFF-ON time
L1	6.2	nH	0201	Murata	LQP03T series. RF choke at LNA output. Influences output match
R1	33K	Ohm	0201	Various	DC biasing
R2	1K	Ohm	0201	Various	RF feedback resistor, output (collector) to input (base). Provides wideband matching, improves stability margin at price of reduced gain and slightly degraded noise figure (~ 0.1 dB).
R3	120	Ohm	0201	Various	DC biasing. Drops supply voltage below transistor's safe limit (V_{CE}); also provides some DC negative feedback to stabilize DC operating point of transistor over temperature, h_{FE} variation of transistor, etc.
Q1	---	---	TSLP-3-9 1.0 x 0.6 x 0.31mm	Infineon Technologies	BFR840L3RHESD SiGe:C RF Transistor
J1, J2	---	---	---	Emerson – Johnson	RF edge Mount SMA Female Connector, 142-0701-841 (Input, Output RF Connectors)
J3	---	---	---	Tyco (AMP)	5 Pin DC connector header, MTA-100 Series, 640456-5

2 Measured Graphs

Noise Figure Plot. From Rohde & Schwarz FS-K3 + FSEM30.
System preamplifier = MITEQ AFS3-00101200-22-10P-4-HS.
Noise Source = Agilent 346A

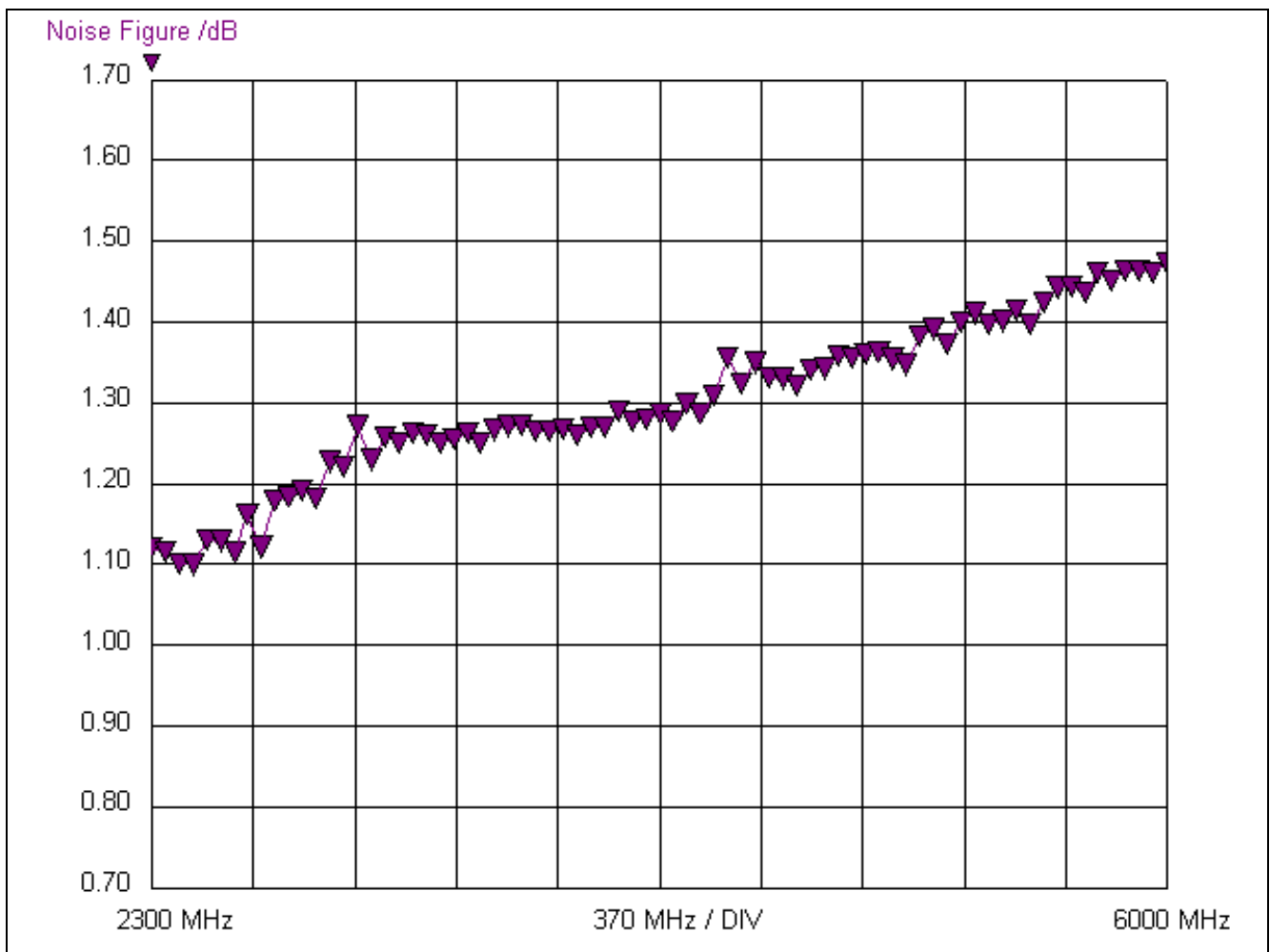

Figure 3 Noise Figure, 2.4 – 6 GHz Wideband / Dual Band LNA

Frequency	Nf	Temp			
2300 MHz	1.12 dB	85.3 K			
2350 MHz	1.12 dB	85 K			
2400 MHz	1.10 dB	83.7 K			
2450 MHz	1.10 dB	83.6 K			
2500 MHz	1.13 dB	86.1 K			
2550 MHz	1.13 dB	86.1 K			
2600 MHz	1.11 dB	84.9 K			
2650 MHz	1.16 dB	89 K			
2700 MHz	1.12 dB	85.5 K			
2750 MHz	1.18 dB	90.5 K			
2800 MHz	1.18 dB	90.9 K			
2850 MHz	1.19 dB	91.6 K			
2900 MHz	1.18 dB	90.7 K			
2950 MHz	1.23 dB	94.7 K			
3000 MHz	1.22 dB	94.2 K			
3050 MHz	1.27 dB	98.6 K			
3100 MHz	1.23 dB	94.9 K			
3150 MHz	1.26 dB	97.5 K			
3200 MHz	1.25 dB	96.8 K			
3250 MHz	1.26 dB	97.8 K			
3300 MHz	1.26 dB	97.7 K			
3350 MHz	1.25 dB	96.8 K	5350 MHz	1.40 dB	110.1 K
3400 MHz	1.26 dB	97.2 K	5400 MHz	1.40 dB	110.4 K
3450 MHz	1.26 dB	97.9 K	5450 MHz	1.42 dB	111.7 K
3500 MHz	1.25 dB	96.8 K	5500 MHz	1.40 dB	110.2 K
3550 MHz	1.27 dB	98.2 K	5550 MHz	1.43 dB	112.7 K
3600 MHz	1.27 dB	98.6 K	5600 MHz	1.44 dB	114.3 K
3650 MHz	1.27 dB	98.8 K	5650 MHz	1.44 dB	114.4 K
3700 MHz	1.27 dB	98.1 K	5700 MHz	1.44 dB	113.7 K
3750 MHz	1.27 dB	98.1 K	5750 MHz	1.46 dB	115.9 K
3800 MHz	1.27 dB	98.4 K	5800 MHz	1.45 dB	115.1 K
3850 MHz	1.26 dB	97.7 K	5850 MHz	1.46 dB	116.3 K
3900 MHz	1.27 dB	98.5 K	5900 MHz	1.46 dB	116.2 K
3950 MHz	1.27 dB	98.5 K	5950 MHz	1.46 dB	116 K
4000 MHz	1.29 dB	100.2 K	6000 MHz	1.47 dB	117.1 K
4050 MHz	1.28 dB	99.2 K			
4100 MHz	1.28 dB	99.5 K			
4150 MHz	1.29 dB	100 K			
4200 MHz	1.28 dB	99.2 K			
4250 MHz	1.30 dB	101.1 K			
4300 MHz	1.29 dB	100 K			
4350 MHz	1.31 dB	102 K			
4400 MHz	1.36 dB	106.3 K			
4450 MHz	1.32 dB	103.4 K			
4500 MHz	1.35 dB	105.7 K			
4550 MHz	1.33 dB	104 K			
4600 MHz	1.33 dB	103.9 K			
4650 MHz	1.32 dB	103.1 K			
4700 MHz	1.34 dB	104.9 K			
4750 MHz	1.34 dB	105 K			
4800 MHz	1.36 dB	106.5 K			
4850 MHz	1.35 dB	106.2 K			
4900 MHz	1.36 dB	106.6 K			
4950 MHz	1.36 dB	106.9 K			
5000 MHz	1.35 dB	106.2 K			
5050 MHz	1.35 dB	105.5 K			
5100 MHz	1.38 dB	108.8 K			
5150 MHz	1.39 dB	109.5 K			
5200 MHz	1.37 dB	107.9 K			
5250 MHz	1.40 dB	110.3 K			
5300 MHz	1.41 dB	111.3 K			

Figure 4 Noise Figure, Tabular Data

Amplifier Compression Point Measurement, 2400 MHz

Gain Compression at 2400 MHz, $V_{CC} = +3.0\text{ V}$, $I = 9.4\text{ mA}$, $V_{CE} = 1.9\text{ V}$, $T = 25^\circ\text{C}$:

ZVB20 Vector Network Analyzer is set up to sweep input power to LNA in a "Power Sweep" at a fixed frequency of 2400 MHz. ZVB20 Port 1, which provides INPUT power to drive the LNA, has its power level calibrated ("SOURCE POWER CAL") with the NRP-Z21 power sensor to ensure power level accuracy with the reference plane at the RF input connector of the amplifier. X-axis of VNA screen-shot below shows input power to LNA swept from -30 to -5 dBm.

Input $P_{1\text{dB}} = -15.6\text{ dBm}$

Output $P_{1\text{dB}} = -15.6\text{ dBm} + (\text{Gain}-1\text{dB}) = -15.6 + 17.5 = +1.9\text{ dBm}$

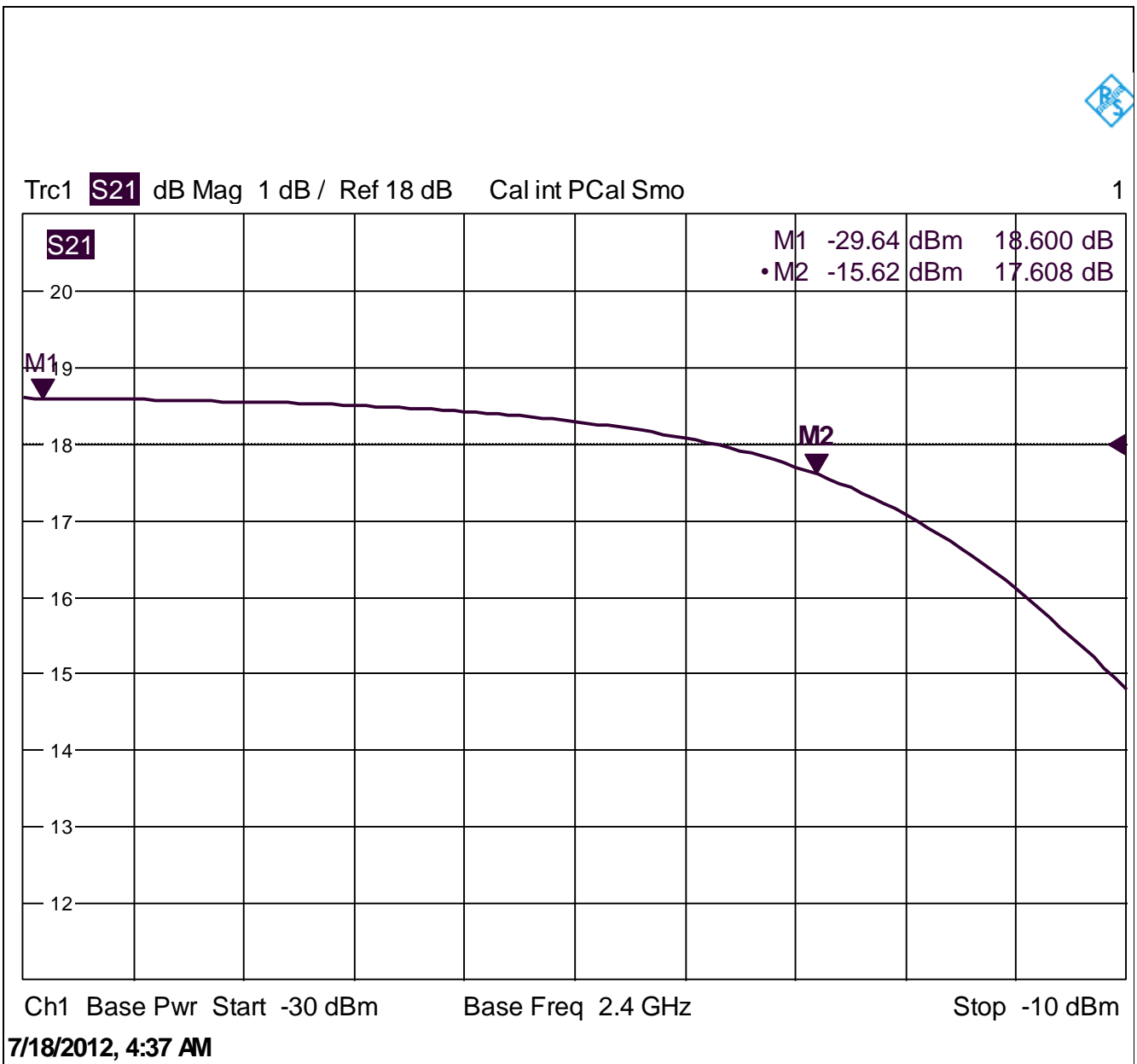

Figure 5 Amplifier Gain compression at 2400 MHz

Amplifier Compression Point Measurement, 5825 MHz

Gain Compression at 5825 MHz, $V_{CC} = +3.0\text{ V}$, $I = 9.4\text{ mA}$, $V_{CE} = 1.9\text{ V}$, $T = 25^\circ\text{C}$:

Input $P_{1\text{dB}} = -12.6\text{ dBm}$

Output $P_{1\text{dB}} = -12.6\text{ dBm} + (\text{Gain}-1\text{dB}) = -12.6 + 13.1 = +0.5\text{ dBm}^*$

*(Used small signal gain from S21 plot on page 16, 14.1 dB gain)

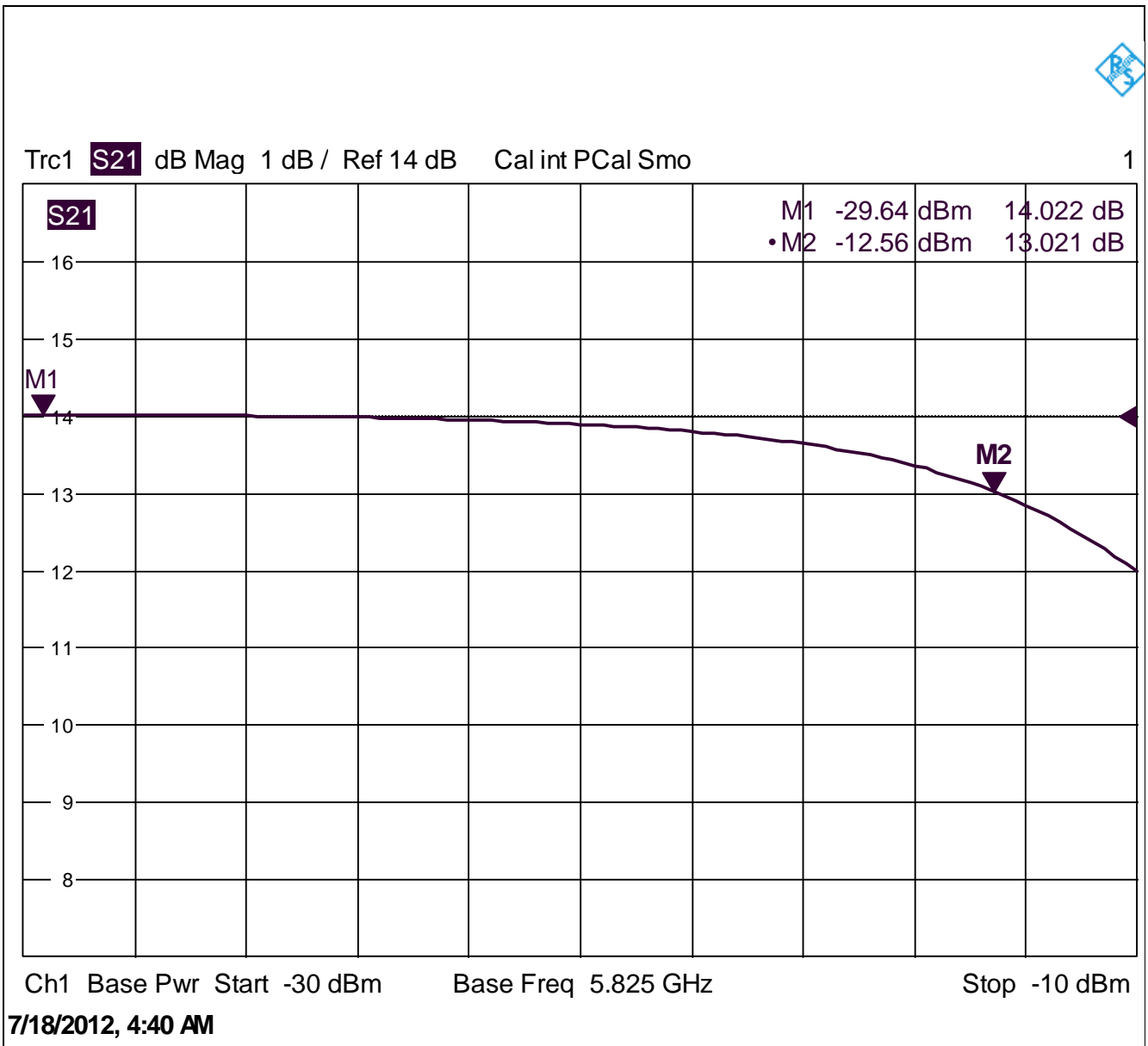

Figure 6 Amplifier Gain Compression at 5825 MHz

Rohde and Schwarz ZVB Network Analyzer Calculates and plots stability factor “ μ_1 ” of the BFR840L3RHESD Wideband LNA in real time. Stability Factor μ_1 is defined as follows [1]:

$$\mu_1 = \frac{1 - |S_{11}|^2}{|S_{22} - S_{11}^* \det(\mathbf{S})| + |S_{21}S_{12}|}$$

The necessary & sufficient condition for Unconditional Stability is $\mu_1 > 1.0$. In the plot, $\mu_1 > 1.0$ over 10 MHz – 12 GHz; **amplifier is Unconditionally Stable over 50 MHz – 12 GHz frequency range.**

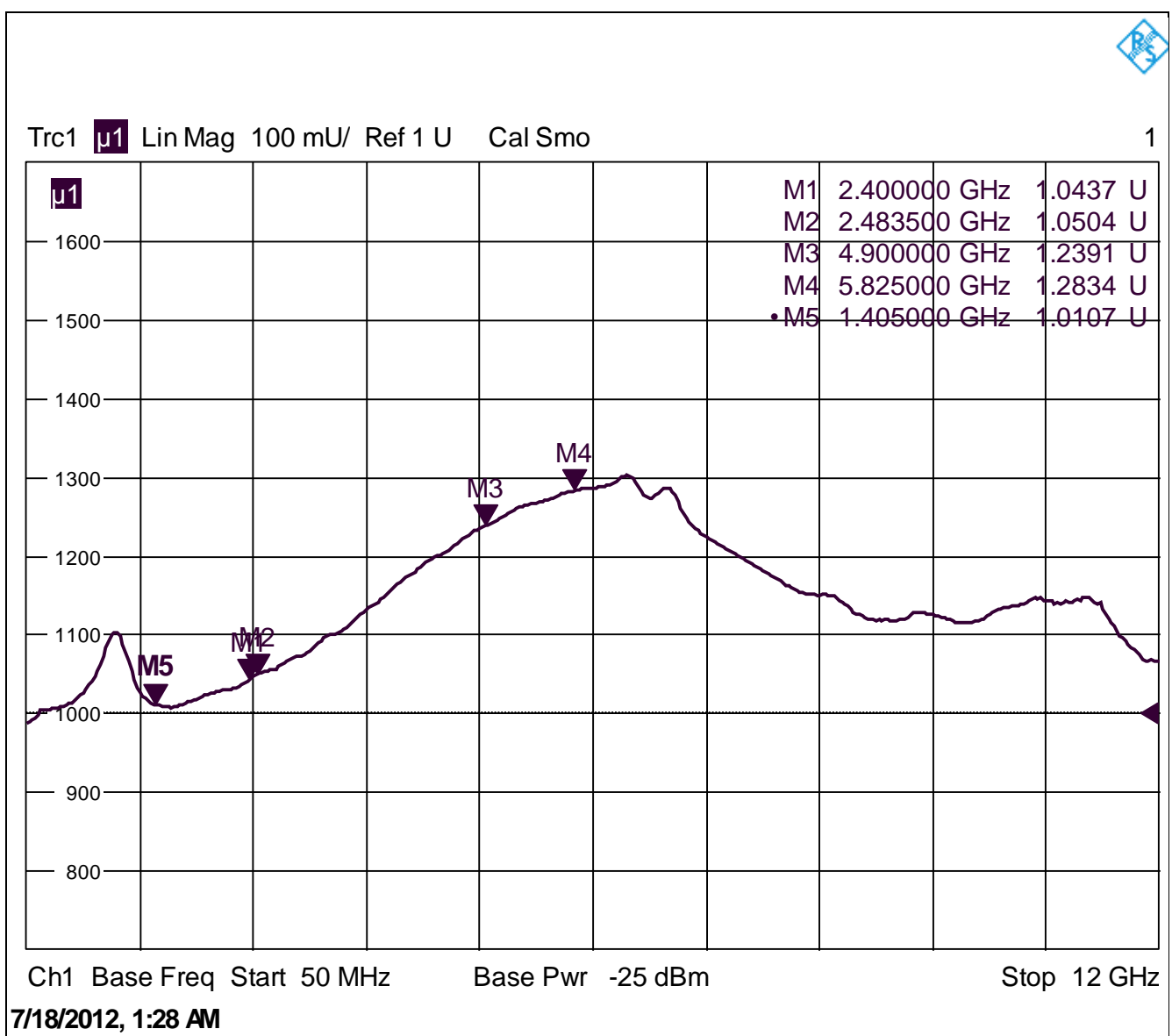

Figure 7 Amplifier stability factor “ μ_1 ”

Note excellent input match of amplifier over entire 2.4 – 6 GHz frequency range.

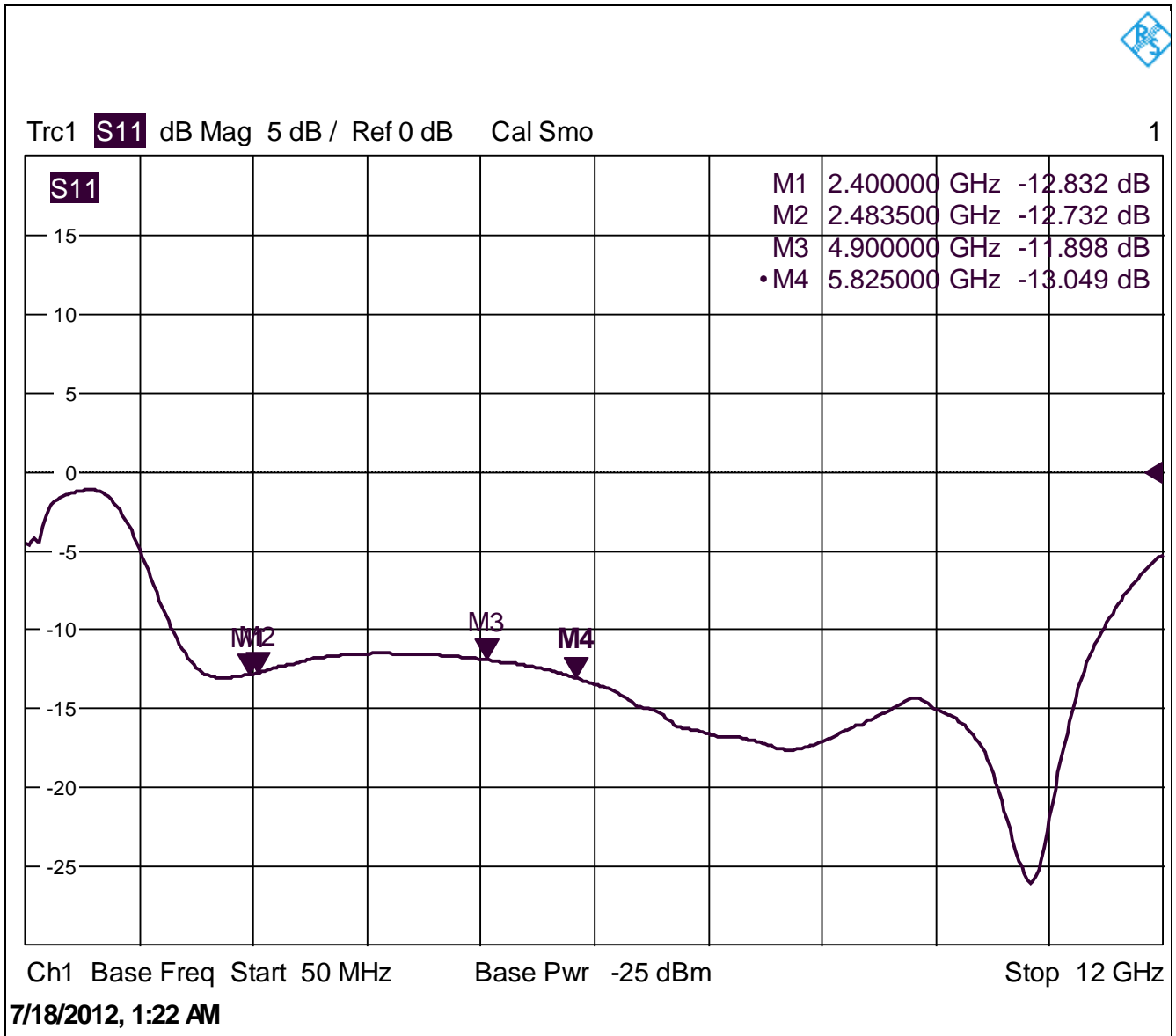

Figure 8 Input Match of Broadband / Dual Band LNA

Reference Plane = SMA RF Input Connector to PC Board.

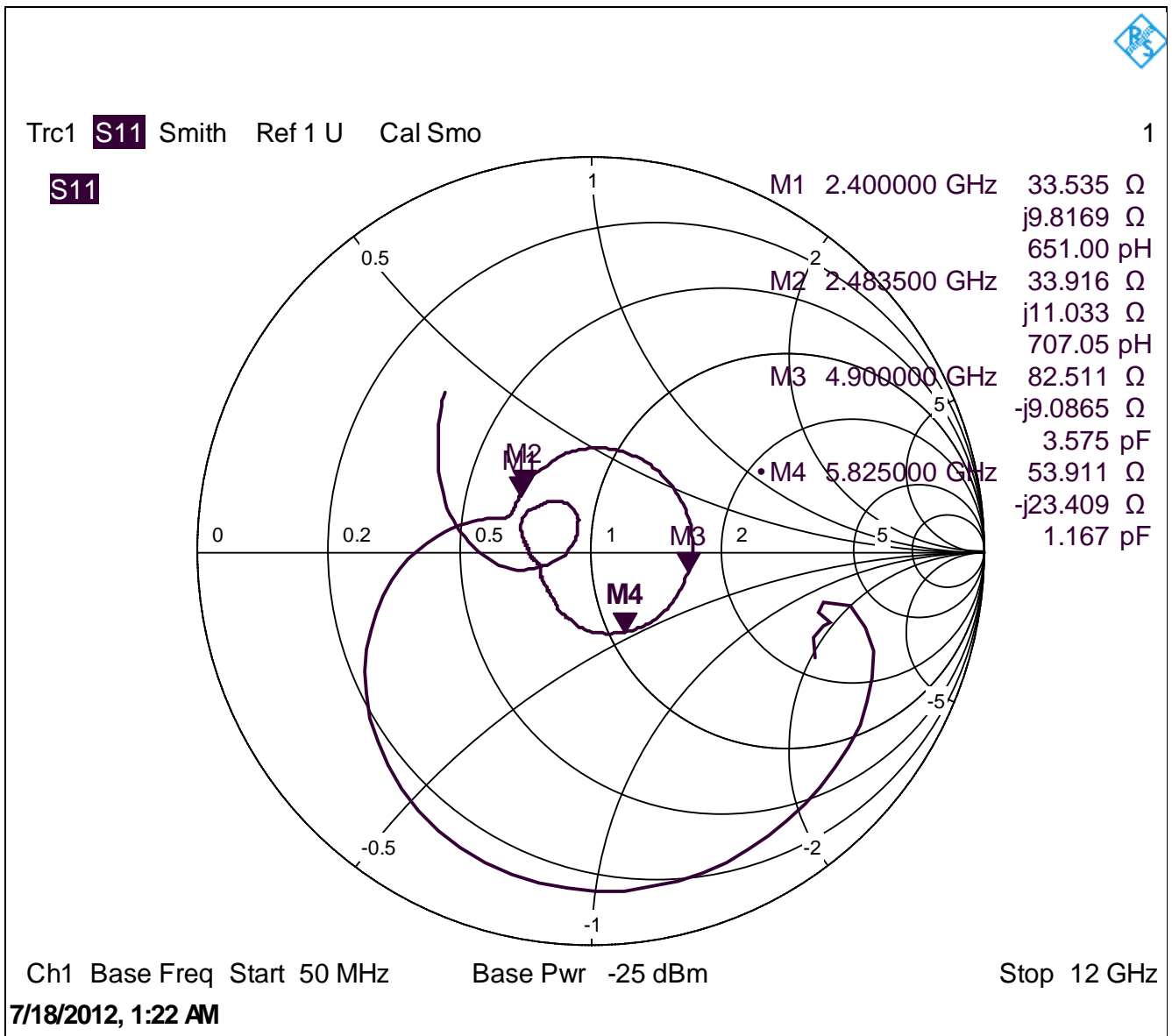

Figure 9 Input Matching of the Broadband / Dual Band LNA, Smith Chart

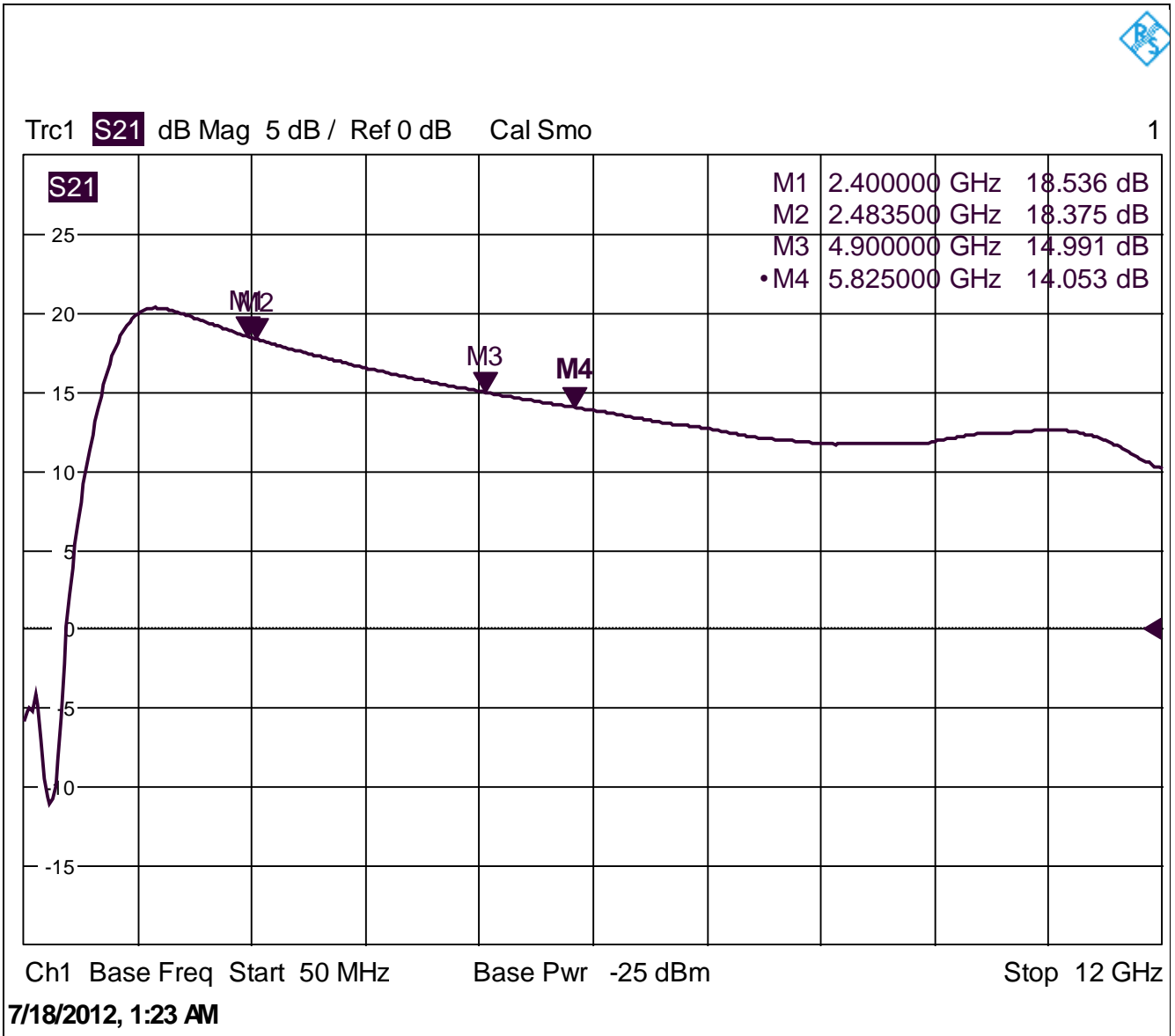

Figure 10 Wideband Gain of Amplifier, DC Power ON

Note: Gain change, ON to OFF, is ~ -38 dB at 2.4 GHz, and ~ -34 dB at 5.8 GHz

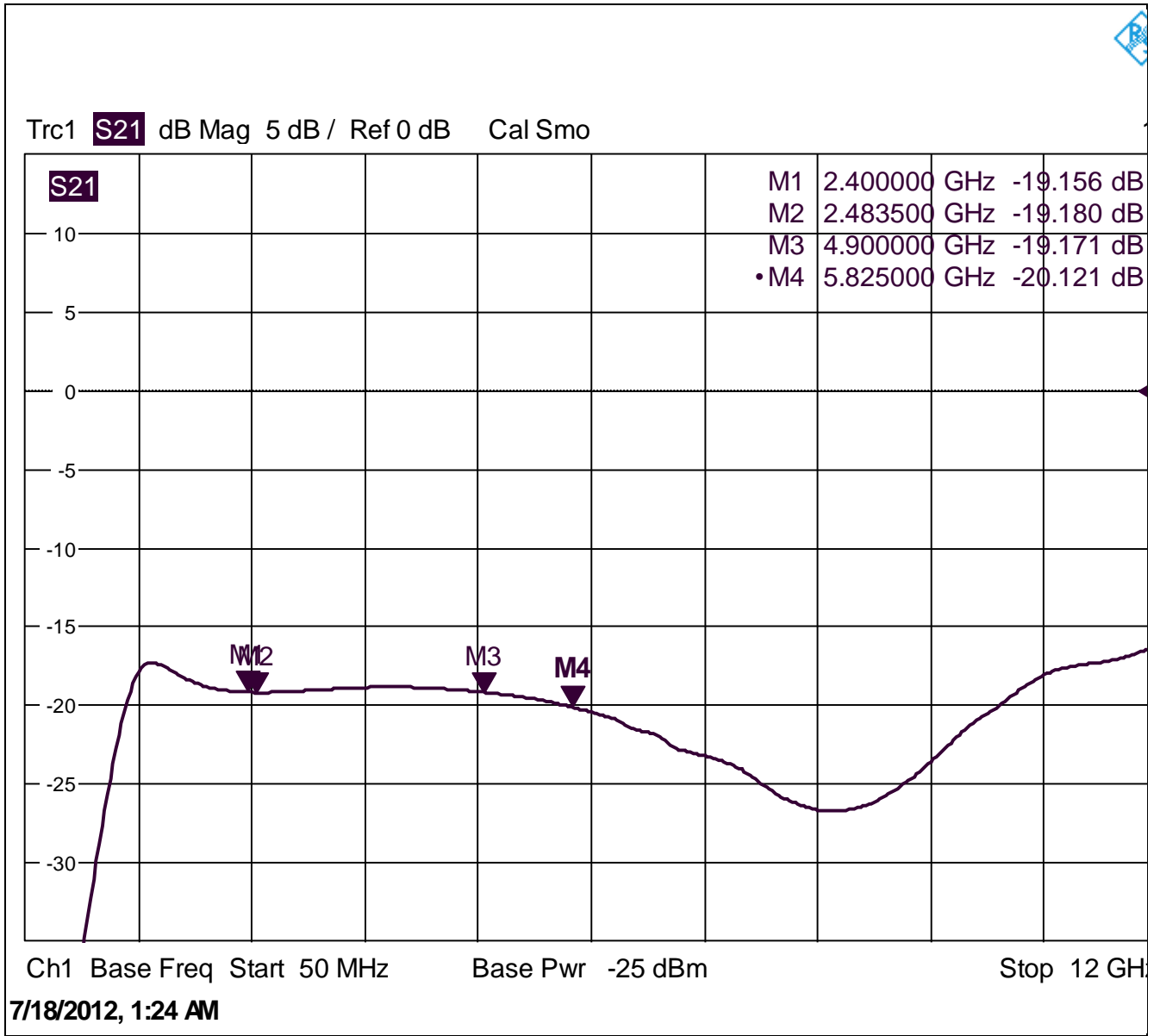

Figure 11 Wideband Gain of Amplifier, DC POWER OFF

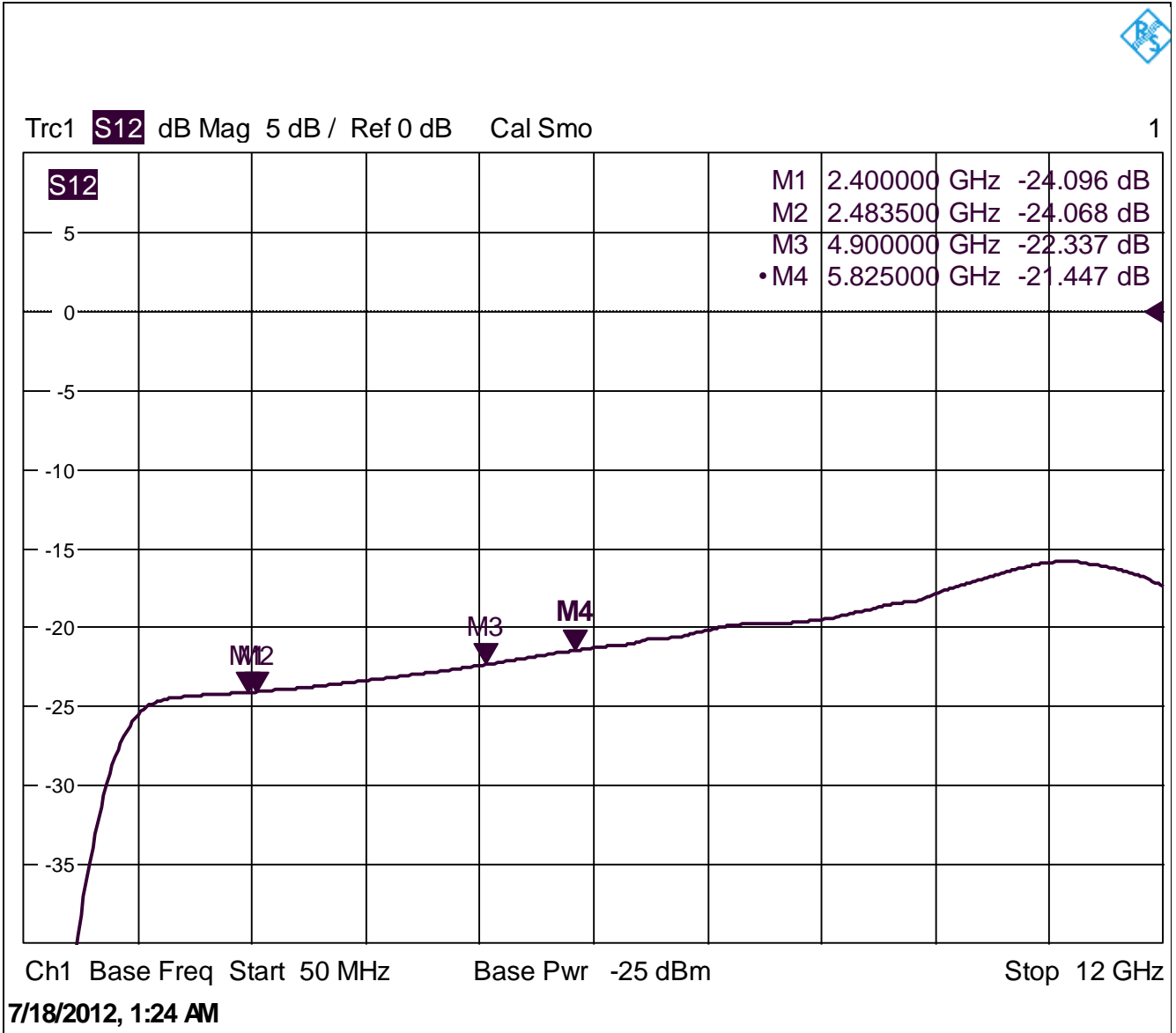

Figure 12 Reverse Isolation, DC power ON

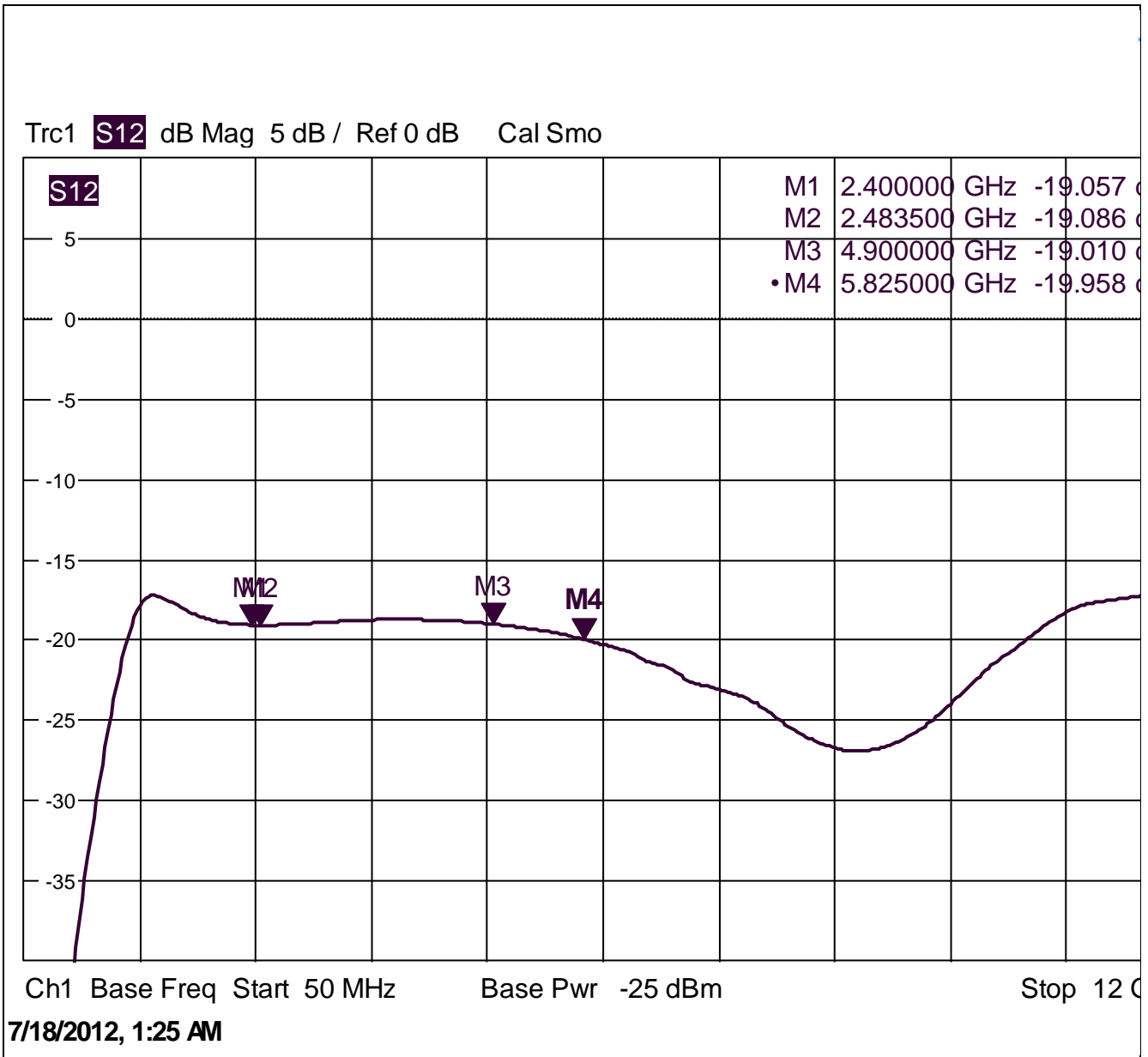

Figure 13 Reverse Isolation, DC Power OFF

Note excellent output match of amplifier over entire 2.4 – 6 GHz frequency range. This eases integration with other receiver chain blocks (i.e. filters, switches, etc.)

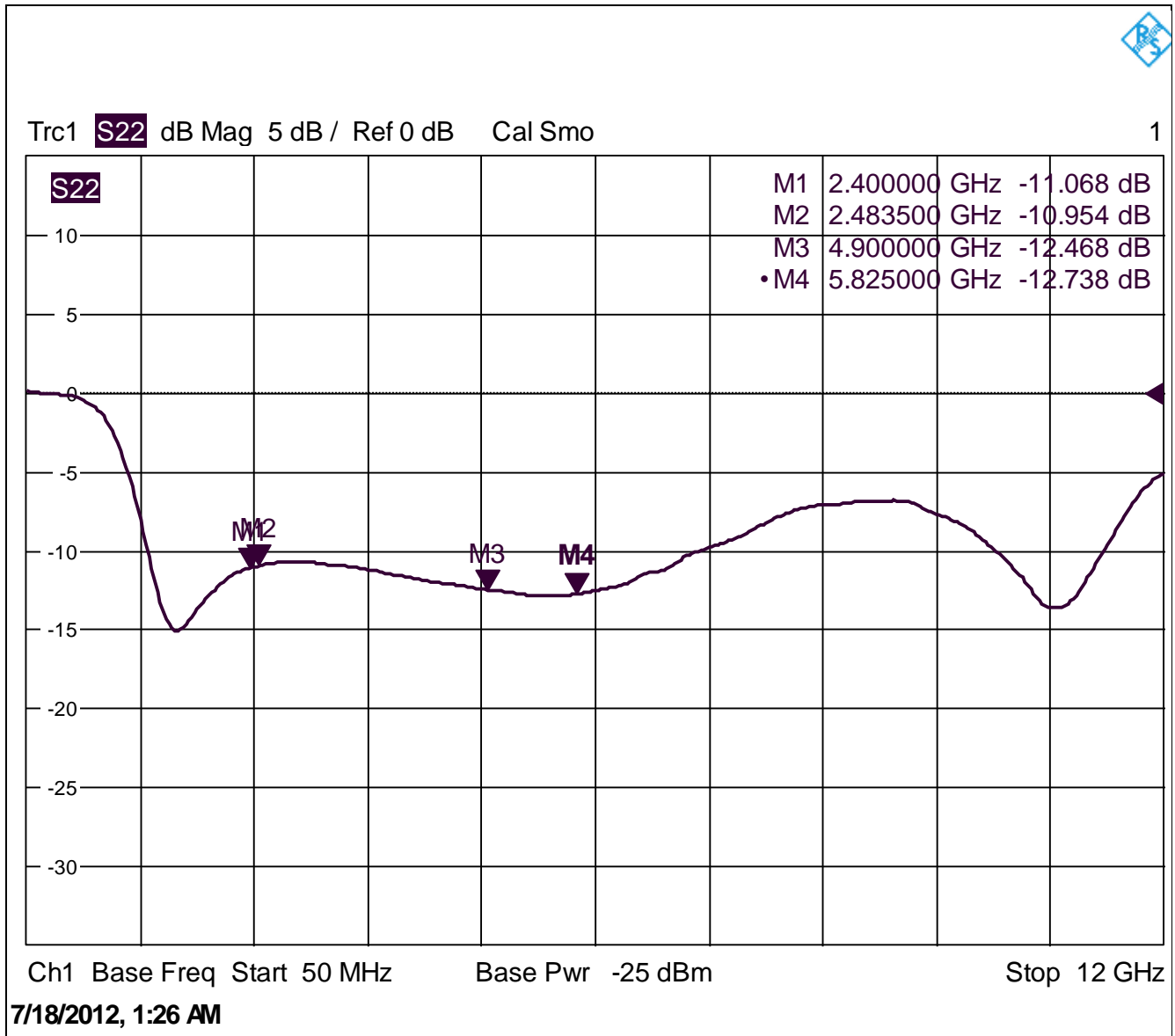

Figure 14 Amplifier Wideband Output Return Loss

Reference Plane = SMA RF Output Connector to PC Board.

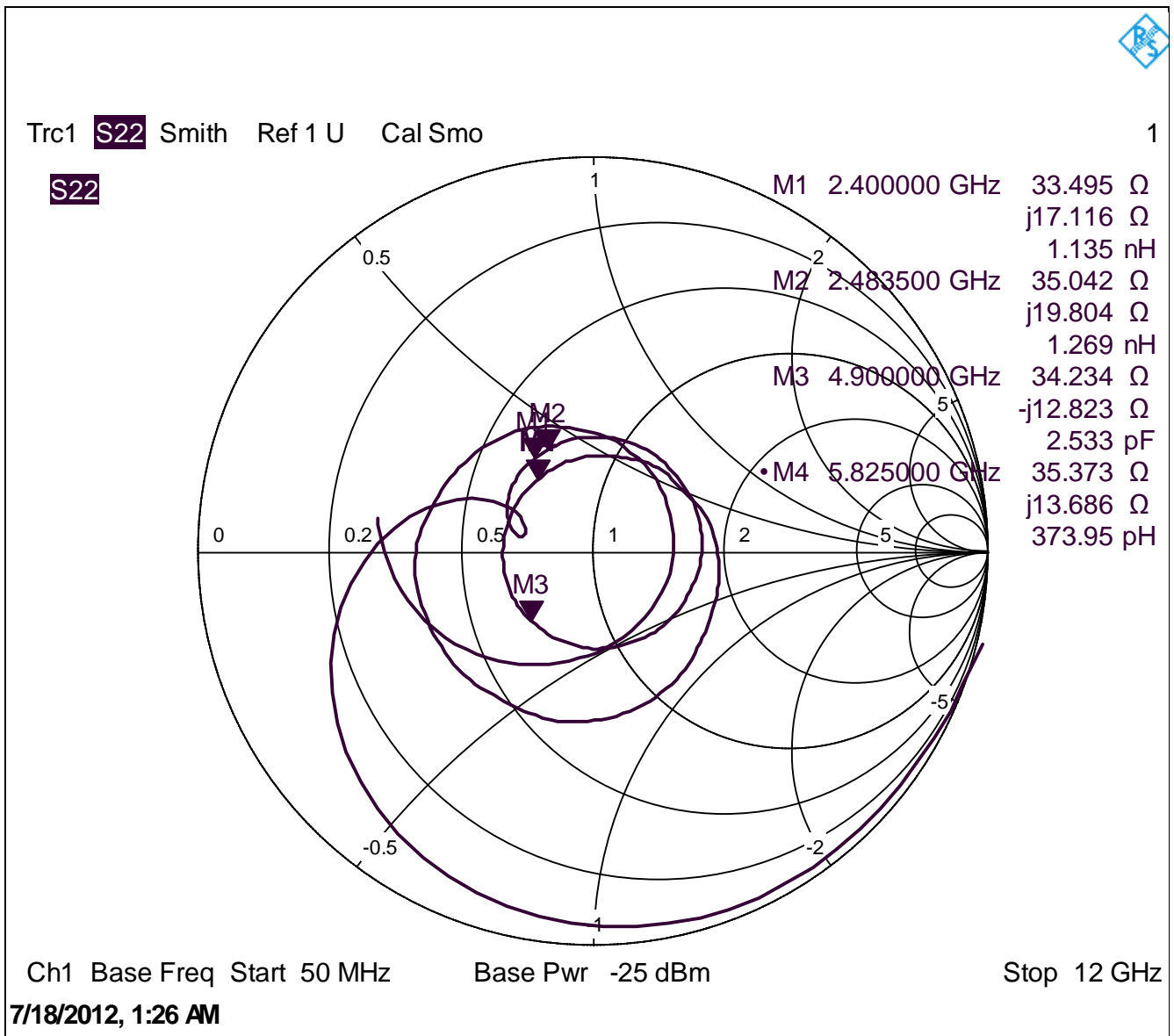

Figure 15 Amplifier Output Return Loss, Smith Chart

In-Band Third Order Intercept (IIP₃) Test, 2400 MHz:

Input Stimulus: $f_1=2400$ MHz, $f_2=2401$ MHz, -28 dBm each tone

Input IP₃ = $-28+(45.0 / 2) = -5.5$ dBm

Output IP₃ = -5.5 dBm + 18.5 dB gain = +13.0 dBm

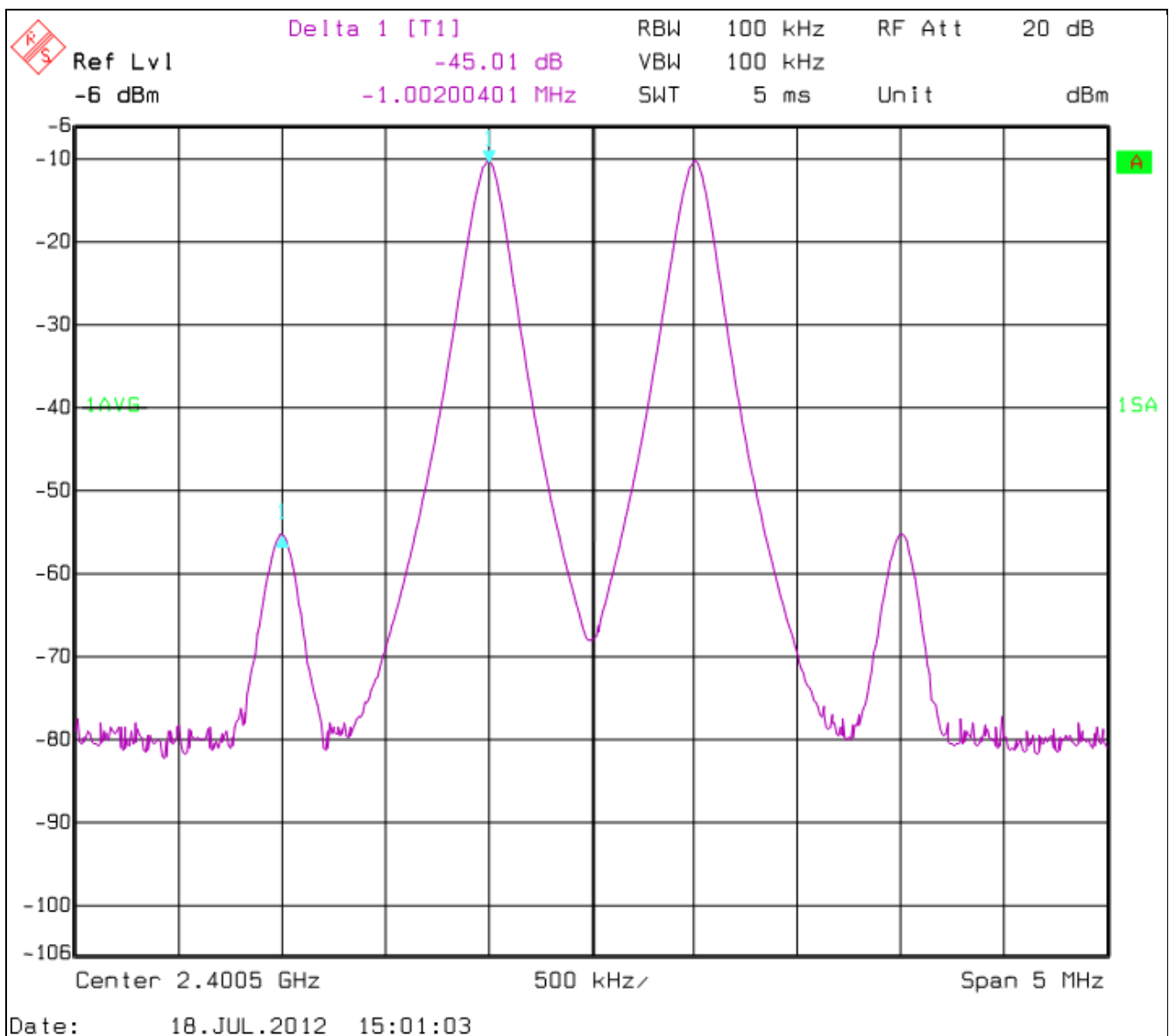

Figure 16 Amplifier Input 3rd Order Intercept Point Measurement, 2400 MHz

Input Third Order Intercept (IIP₃) Test, 5825 MHz:

Input Stimulus: $f_1=5824$ MHz, $f_2=5825$ MHz, -28 dBm each tone

Input IP₃ = $-28+(56.6 / 2) = +0.3$ dBm

Output IP₃ = $+0.3$ dBm + 14.1 dB gain = +14.4 dBm

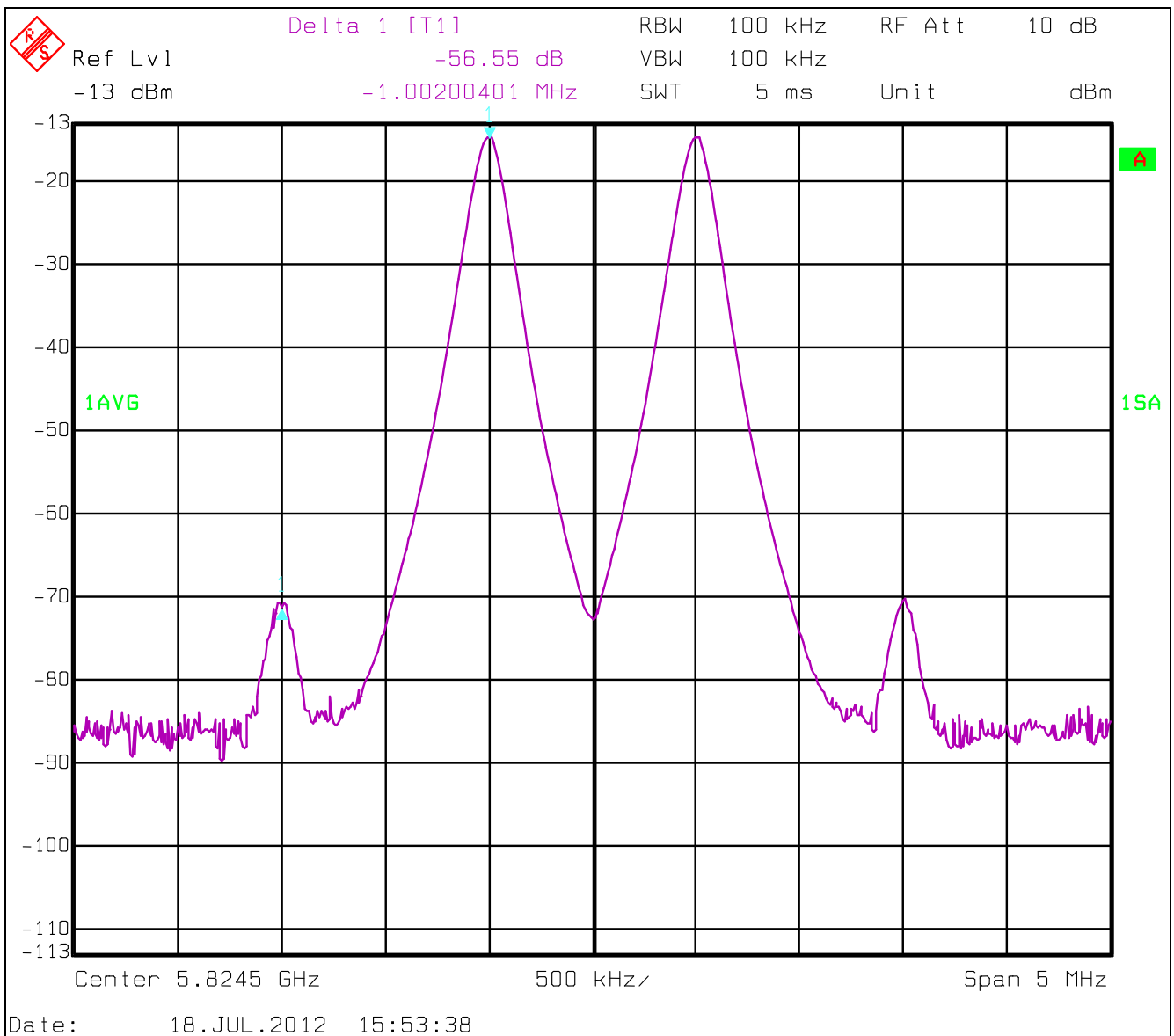

Figure 17 Amplifier Input 3rd Order Intercept Point Measurement, 5825 MHz

Block Diagram, Test Setup for Amplifier Turn-On / Turn Off time measurement

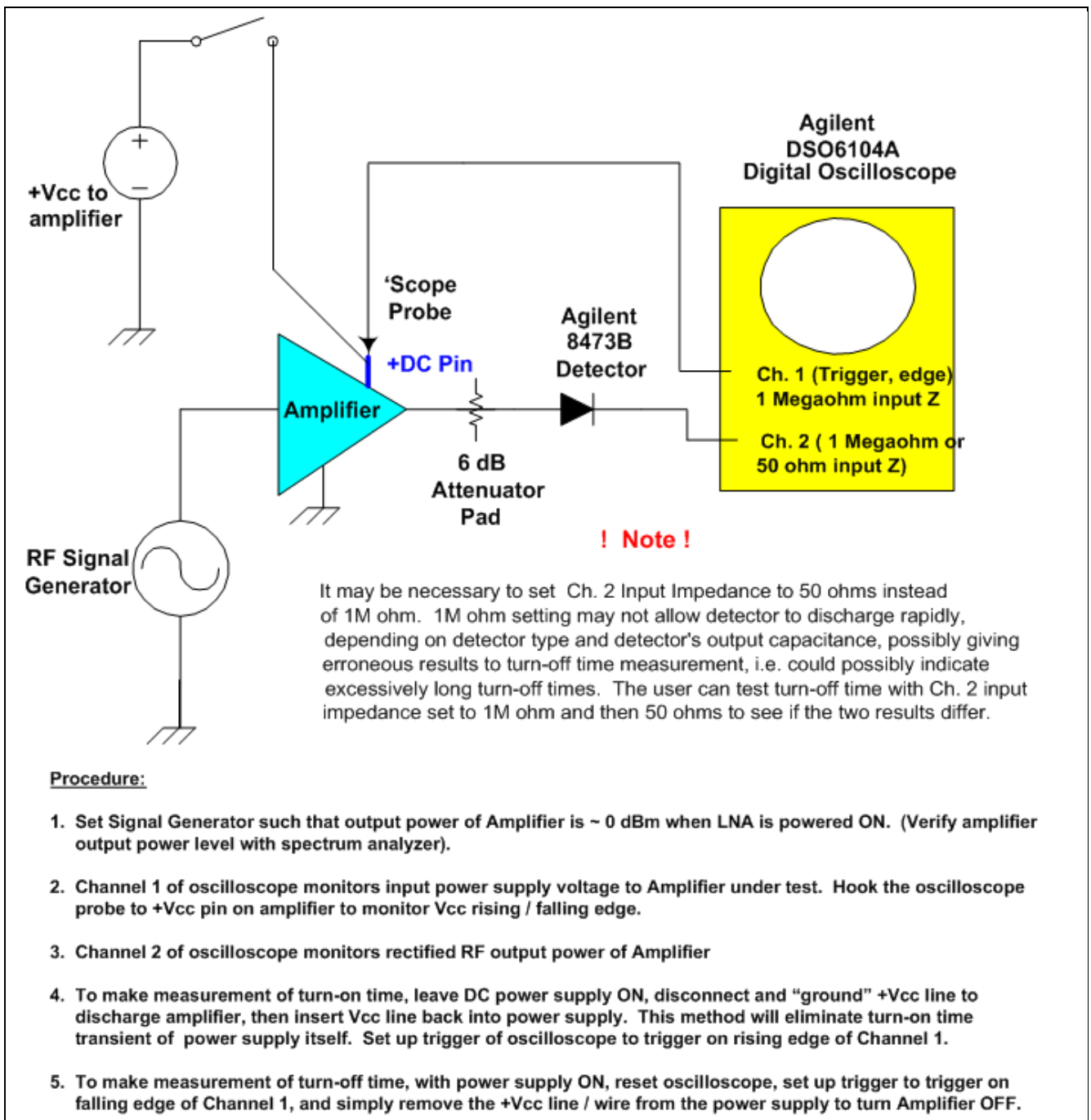

Figure 18 Diagram of Setup for Making Amplifier Turn-On and Turn-Off Times.

Amplifier Turn On Time:

Refer to oscilloscope screen-shot below. Upper trace (yellow, Channel 1) is the DC power supply turn-on step waveform whereas the lower trace (green, Channel 2) is the rectified RF output signal of the LNA stage. **Amplifier turn-on time is approximately 15 nanoseconds, or ~ 0.015 microseconds.** Main source of time delay in the LNA turn-on event are the R-C time constants formed by (R3 * C4), etc. Charge storage has been minimized in this circuit so as to speed up turn on and turn off times. (Refer to Schematic diagram on page X).



Figure 19 Oscilloscope Screen Shot, Amplifier Turn-On Time

Amplifier Turn-Off time

Upper trace (Channel 1, yellow color) is the falling edge of the DC power supply voltage. Rectified RF output signal (Channel 2, lower green trace) takes **about ~ 15 nanoseconds, or 0.015 microseconds**, to settle out after power supply is turned off.

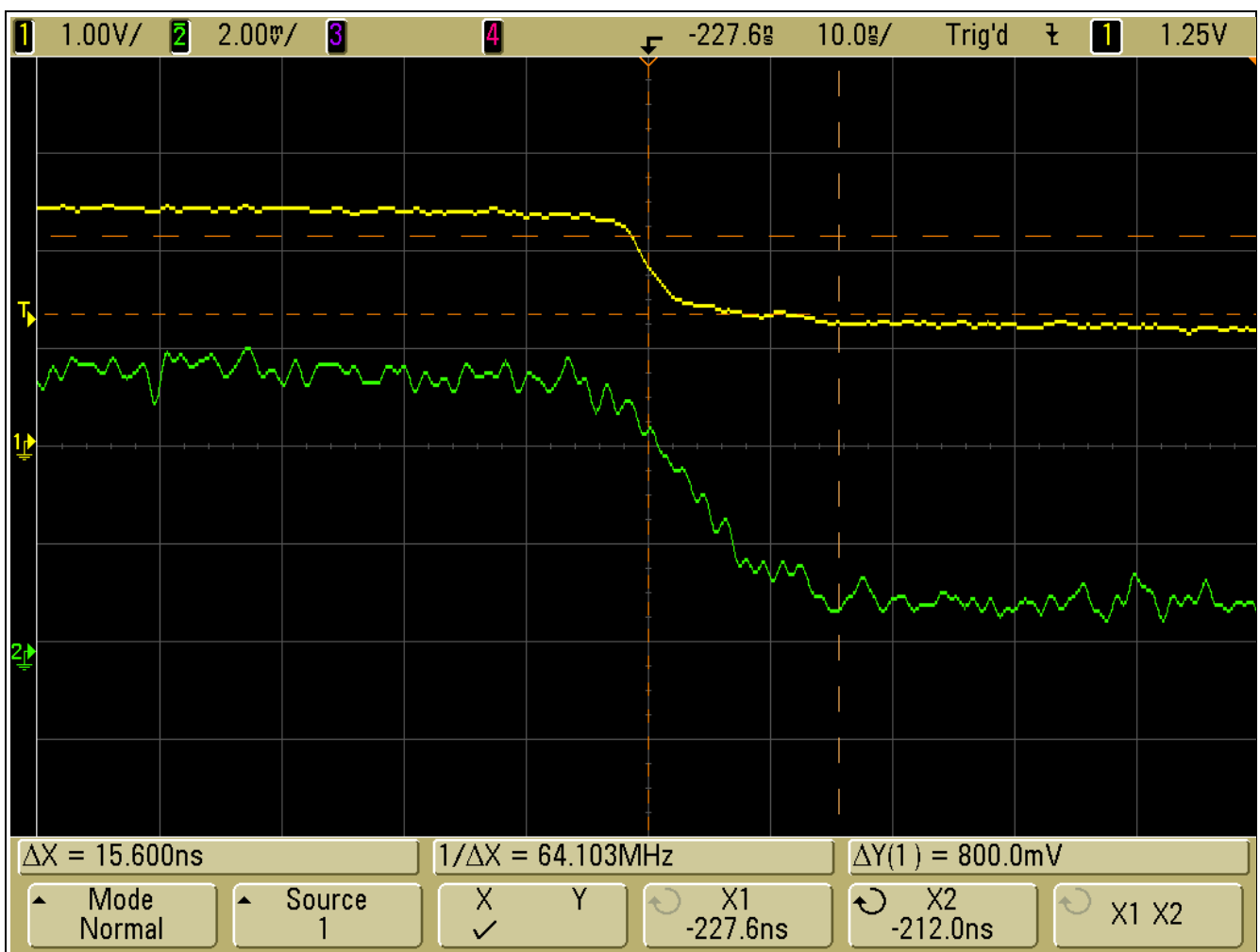

Figure 20 Oscilloscope Screen-Shot, Amplifier Turn-Off Time

3 Evaluation Board and Layout Information

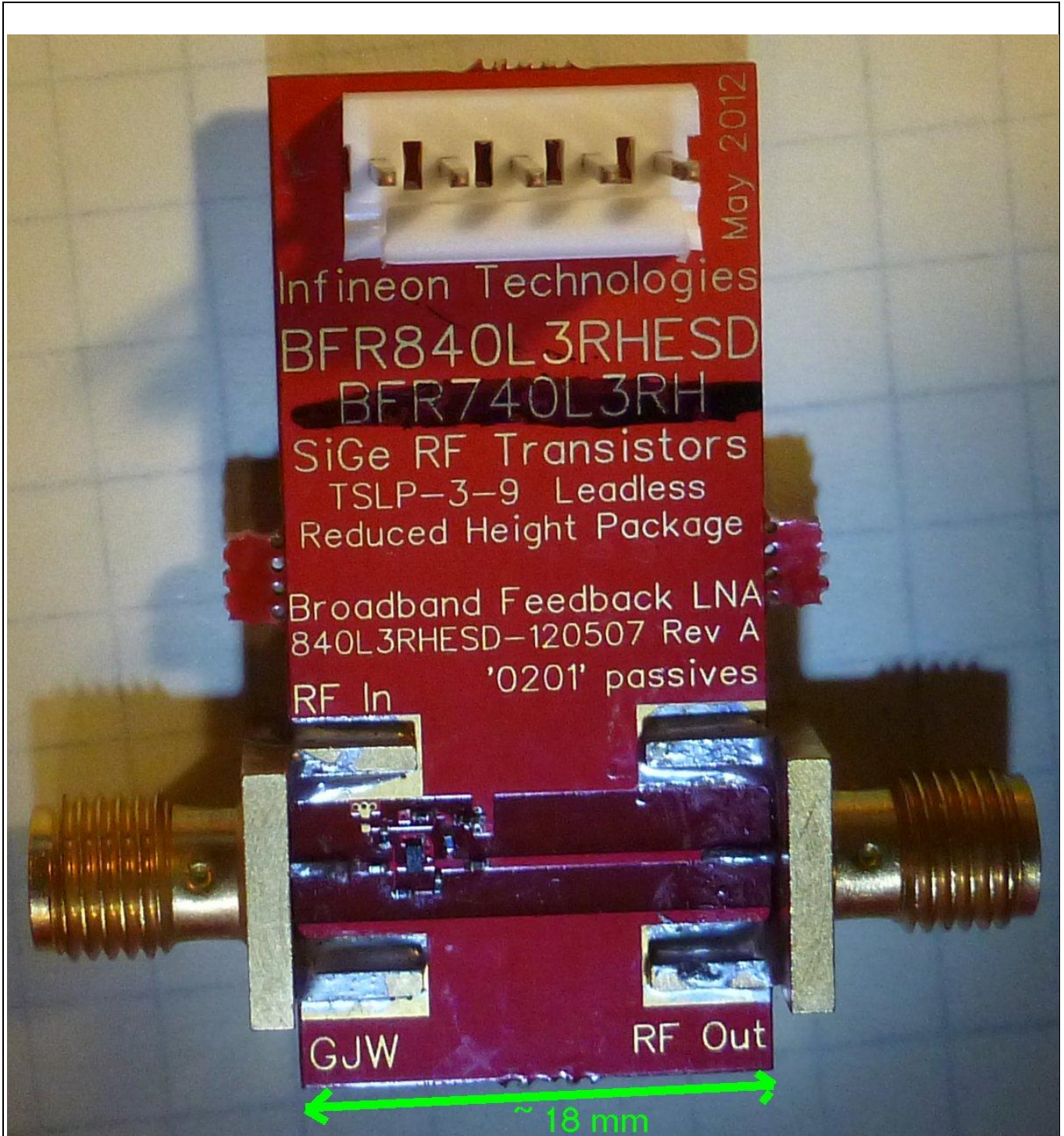

Figure 21 View of Entire PC Board

Note – five (5) 0.2mm diameter ground via holes are used for grounding (emitter connection) near top right corner of Q1. R2 is the feedback resistor (RF Feedback).

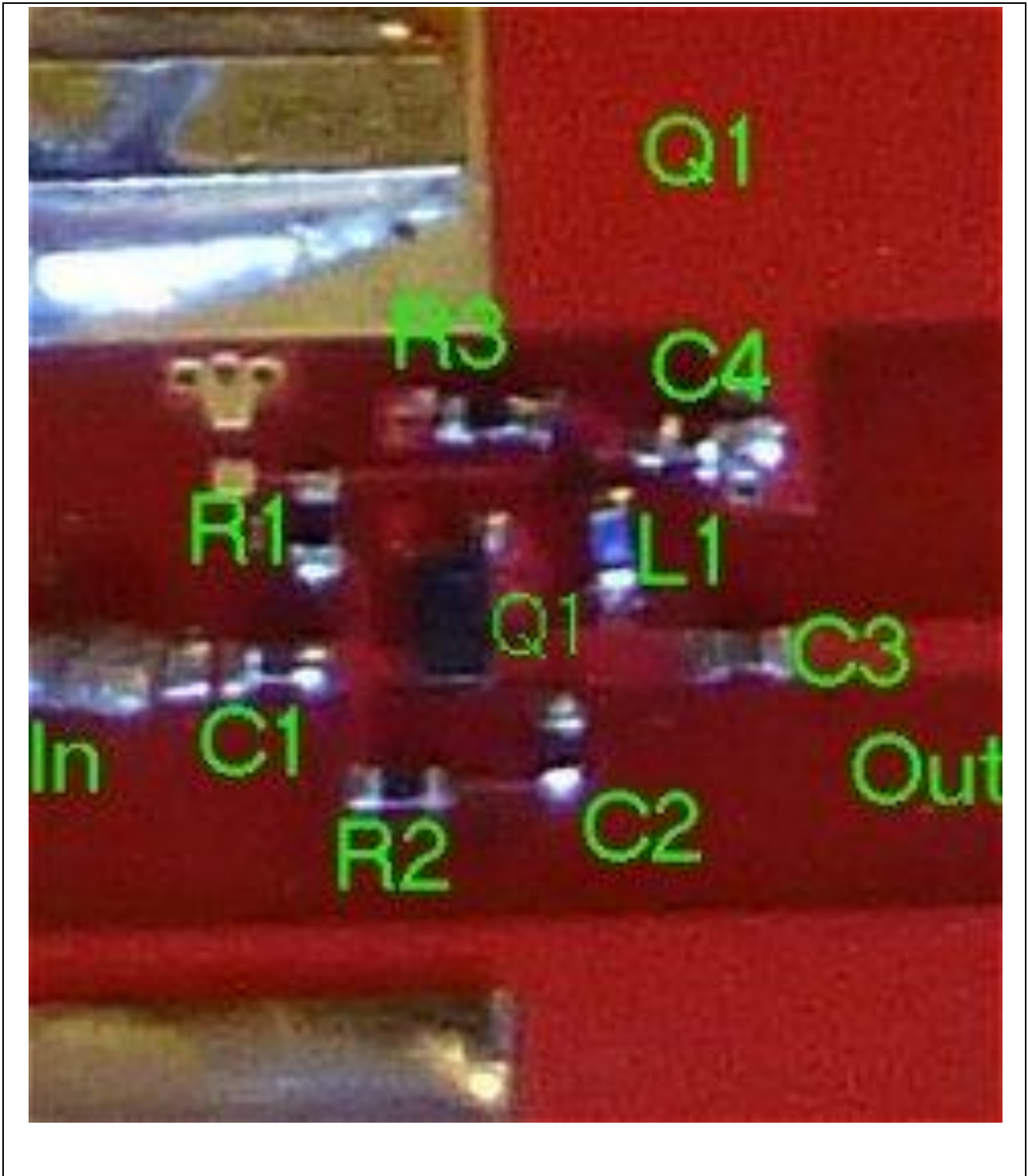

Figure 22 Close-In View of BFR840L3RHESD Wideband / Dualband LNA.

Note – standard low-cost “FR4” PC board material is used.

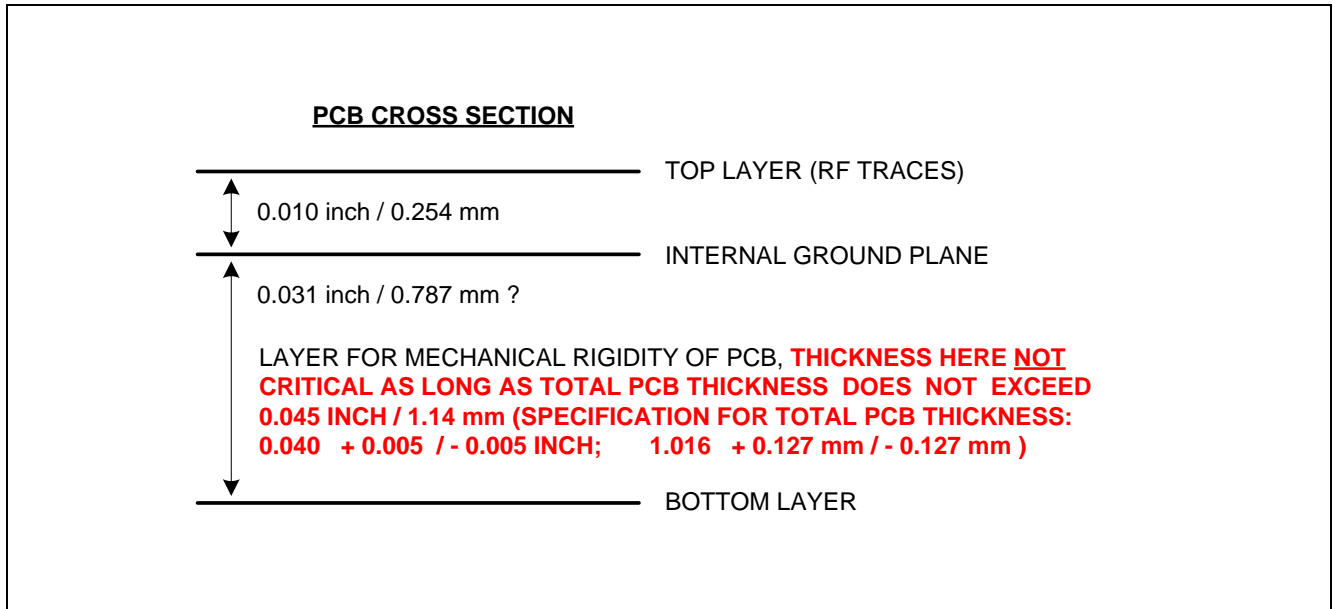

Figure 23 PC Board Cross-Section Information.

4 Author

Gerard Wevers, Senior Staff Applications Engineer of Business Unit “RF and Protection Devices”.

5 Remark

The data graphs are exported from the Rohde and Schwarz ZVB network analyzer, FS-K3 Noise Figure Measurement system, or Agilent DSO6104A Oscilloscope.

www.infineon.com