

**BFP720FESD**

**Dual Band LNA for WiMAX/WLAN  
2.3-2.7GHz and 5-6GHz applications**

**Application Note AN187**

Revision: Rev. 1.0  
2010-10-11

**Edition 2010-10-11**

**Published by  
Infineon Technologies AG  
81726 Munich, Germany**

**© 2010 Infineon Technologies AG  
All Rights Reserved.**

#### **Legal Disclaimer**

The information given in this document shall in no event be regarded as a guarantee of conditions or characteristics. With respect to any examples or hints given herein, any typical values stated herein and/or any information regarding the application of the device, Infineon Technologies hereby disclaims any and all warranties and liabilities of any kind, including without limitation, warranties of non-infringement of intellectual property rights of any third party.

#### **Information**

For further information on technology, delivery terms and conditions and prices, please contact the nearest Infineon Technologies Office ([www.infineon.com](http://www.infineon.com)).

#### **Warnings**

Due to technical requirements, components may contain dangerous substances. For information on the types in question, please contact the nearest Infineon Technologies Office.

Infineon Technologies components may be used in life-support devices or systems only with the express written approval of Infineon Technologies, if a failure of such components can reasonably be expected to cause the failure of that life-support device or system or to affect the safety or effectiveness of that device or system. Life support devices or systems are intended to be implanted in the human body or to support and/or maintain and sustain and/or protect human life. If they fail, it is reasonable to assume that the health of the user or other persons may be endangered.



## Table of Content

1	<b>Introduction .....</b>	<b>5</b>
2	<b>Using BFP720FESD for WiMAX/WLAN 2.3-2.7GHz and 5-6GHz Applications .....</b>	<b>6</b>
3	<b>Application Information .....</b>	<b>8</b>
4	<b>Typical Measurement Results.....</b>	<b>9</b>
5	<b>Measured graphs from 2.3 to 2.7GHz.....</b>	<b>10</b>
6	<b>Measured graphs from 5.0 to 6.0GHz.....</b>	<b>14</b>
7	<b>Evaluation Board and layout Information.....</b>	<b>20</b>
	<b>Authors.....</b>	<b>21</b>

## List of Figures

Figure 1	BFP720FESD in TSFP-4 Package .....	5
Figure 2	WiMAX/WLAN Transceiver system.....	7
Figure 3	Schematics of the application circuit.....	8
Figure 4	Insertion power gain of the BFP720FESD for WLAN/Wimax at 2.3-2.7GHz.....	10
Figure 5	Noise figure of the BFP720FESD for WLAN/Wimax at 2.3-2.7GHz .....	10
Figure 6	Input matching of the BFP720FESD for WLAN/Wimax at 2.3-2.7GHz.....	11
Figure 7	Output matching of the BFP720FESD for WLAN/Wimax at 2.3-2.7GHz.....	11
Figure 8	Reverse Isolation of the BFP720FESD for WLAN/Wimax at 2.3-2.7GHz .....	12
Figure 9	Input 1dB compression point of the BFP720FESD for WLAN/Wimax at 2.3-2.7GHz .....	12
Figure 10	Output 3 <sup>rd</sup> order Intercept point of the BFP720FESD for WLAN/Wimax at 2.3-2.7GHz.....	13
Figure 11	Input and Output impedance of the BFP720FESD for WLAN/Wimax at 2.3-2.7GHz.....	13
Figure 12	Insertion power gain of the BFP720FESD for WLAN/Wimax at 5-6GHz.....	14
Figure 13	Noise figure of the BFP720FESD for WLAN/Wimax at 5-6GHz .....	14
Figure 14	Input matching of the BFP720FESD for WLAN/Wimax at 5-6GHz.....	15
Figure 15	Output matching of the BFP720FESD for WLAN/Wimax at 5-6GHz.....	15
Figure 16	Reverse isolation of the BFP720FESD for WLAN/Wimax at 5-6GHz.....	16
Figure 17	Input 1dB compression point of the BFP720FESD for WLAN/Wimax at 5-6GHz .....	16
Figure 18	Output 3 <sup>rd</sup> order intercept point of the BFP720FESD for WLAN/Wimax at 5-6GHz .....	17
Figure 19	Input and Output impedance of the BFP720FESD for WLAN/Wimax at 5-6GHz.....	17
Figure 20	K-factor stability of the BFP720FESD for WLAN/Wimax 2.3-2.7&5-6GHz applications.....	18
Figure 21	$\mu$ -factor stability of the BFP720FESD for WLAN/Wimax 2.3-2.7&5-6GHz applications .....	18
Figure 22	Rise switching time of the BFP720FESD for WLAN/Wimax 2.3-2.7&5-6GHz applications.....	19
Figure 23	Fall switching time of the BFP720FESD for WLAN/Wimax 2.3-2.7&5-6GHz applications .....	19
Figure 24	PCB Picture of Evaluation Board .....	20
Figure 25	PCB Layer Information .....	20

## List of Tables

Table 1	Pin definition.....	5
Table 2	Bill-of-Materials.....	8
Table 3	Summary of Measurement results for WiMAX/WLAN 2.3-2.7GHz (at room temperature).....	9
Table 4	Summary of Measurement results for WiMAX/WLAN 5-6GHz (at room temperature).....	9

## 1 Introduction

### 1.1 Features

- Robust high performance low noise amplifier based on Infineon's reliable, high volume SiGe:C wafer technology
- 2 kV ESD robustness (HBM) due to integrated protection circuits
- Thin, small, flat, Pb- and halogen free (RoHS compliant) package with visible leads

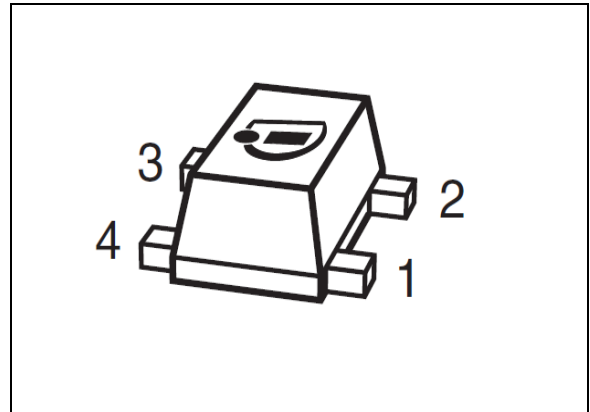

**Figure 1** BFP720FESD in TSFP-4 Package

### 1.2 Applications

The BFP720FESD from Infineon Technologies is a SiGe:C Heterojunction bipolar transistor dedicated for low noise amplifiers applications. Packaged into a TSFP-4 package, this transistor is easy-to-use for the designs. The pin configuration is shown in [Table 1](#).

**Table 1** Pin definition

Pin	Pin name	Comments
1	B	Base of the BFP720FESD transistor
2	E	Emitter of the BFP720FESD transistor
3	C	Collector of the BFP720FESD transistor
4	E	Emitter of the BFP720FESD transistor

This component is also suitable for WiMAX middle band (from 3.3 to 3.7GHz) and is therefore interesting for all the WiMAX/WLAN applications. However, this device fits for all GPS LNAs (1575MHz) and also for cordless phones systems(5.8GHz).

## **2 Using BFP720FESD for WiMAX/WLAN 2.3-2.7GHz and 5-6GHz Applications**

Since the last 50 years, we saw a constant evolution on the field of wireless communications. Humans always try to communicate even longer and with the biggest amount of information to share. As the technology is getting more and more portative, the need to transfer datas and networks without any cable became important.

Nowadays, with the progress of technology regarding cell phones and others communication supports like computers and internet, the information traffic is getting heavier and heavier. Therefore, the telecommunications authorities which regulate and allocate frequency bands to users (military or public applications) have adopted the WLAN standards IEEE 802.11 a, b, and g... with different frequency bands especially dedicated for local area networks (LAN) in order to link computers to the web internet.

But, where the link to internet is difficult to provide or the infrastructures are getting too much expensive for places like villages or small towns, a new solution called WiMAX appeared. This standard that internet providers are now more and more developing, is created to link towns to the Wide Area Network (WAN) using wireless connections. Thus, users are able to use WiMAX from office to home with a wireless link.

**Using BFP720FESD for WiMAX/WLAN 2.3-2.7GHz and 5-6GHz Applications**

This application note describes the BFP720FESD performances for WiMAX and WLAN high/low bands.

The **Figure 2** presents the transmission reception Tx/Rx at each user side. In order to receive and treat the signal information received at the antenna, the weak signal needs to be amplified. Therefore, the use of an LNA is essential to amplify the signal, generating a really low noise and thus, preserve the signal integrity. The use of BFP720FESD is interesting for this application, since, it is amplifying both high and also Low band signals regarding WLAN and WiMAX.

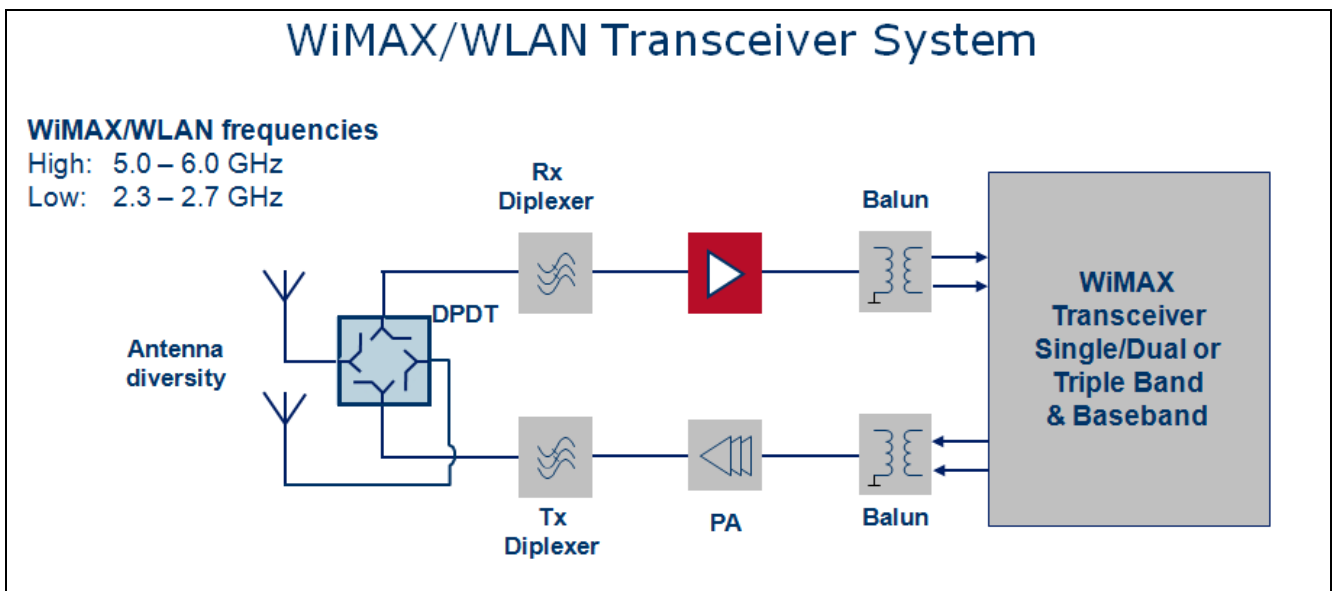

**Figure 2** WiMAX/WLAN Transceiver system

The BFP720FESD is here presented in LNA configuration (please see the **Figure 3** for the circuit schematic and **Table 2** for the Bill-of-Materials). A summary of measurement results is located on **Table 3** and **Table 4**

The LNA provides a gain of about 17.5 dB in low Band and 13.5 dB in high band of the WiMAX/WLAN standard. This LNA brings for both bands a maximum noise figure of 1.3 dB. The input and output are matched to 50 Ω with at least 8.0 dB matching (worse value observed at output at 2.4 GHz).

The input 1dB compression point is reaching -16.0 dBm (low band) and -8.5 dBm (high band). The input 3<sup>rd</sup> Order intercept point is located at -8.0 dBm (low band) and 3.5 dBm (high band).

### 3 Application Information

#### 3.1 Schematic diagram

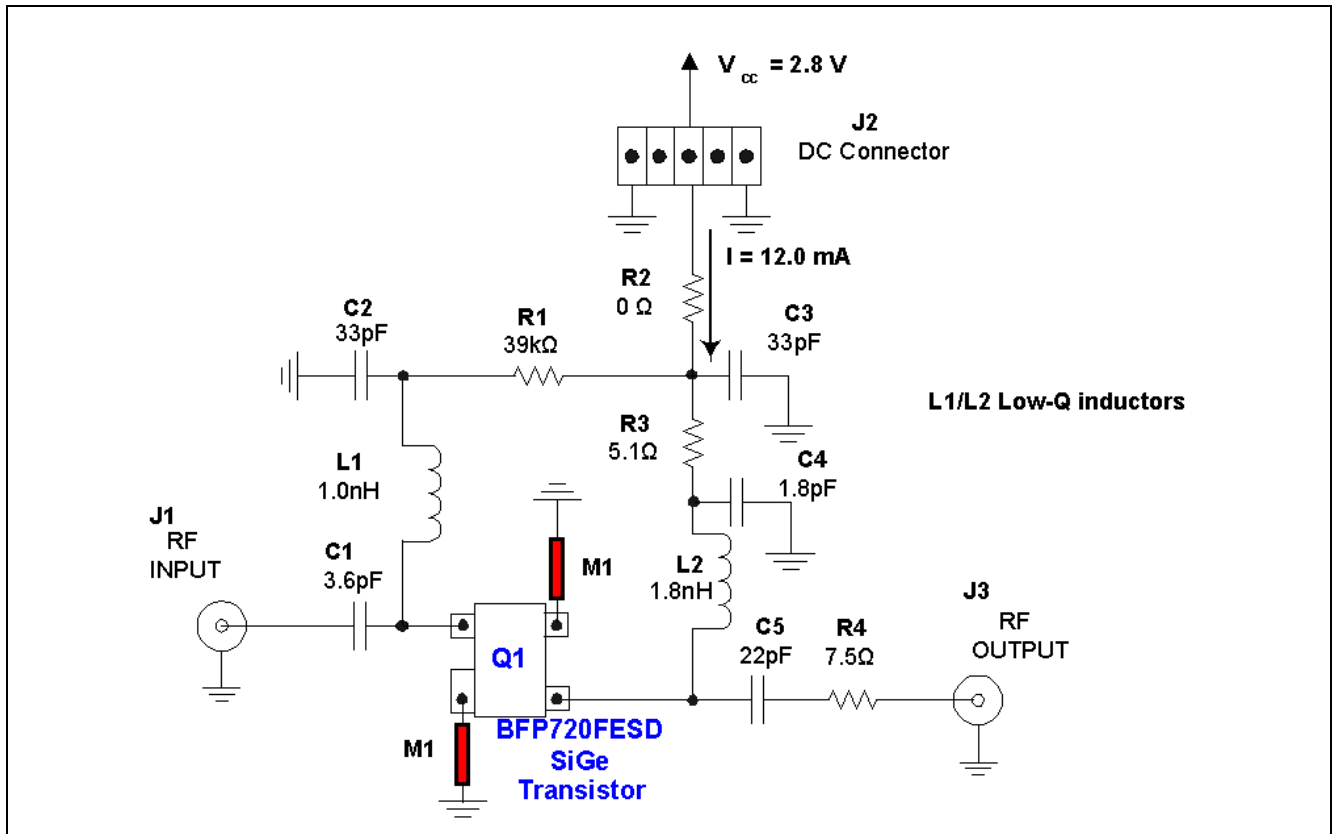

Figure 3 Schematic diagram of the application circuit

Table 2 Bill-of-Materials

Symbol	Value	Unit	Size	Manufacturer	Comment
C1	3.6	pF	0402	Various	Input Matching/DC Block
C2	33	pF	0402	Various	RF signal to ground
C3	33	pF	0402	Various	RF signal to ground
C4	1.8	pF	0402	Various	Output Matching/ Stability
C5	22	pF	0402	Various	Output Matching/DC Block
L1	1.0	nH	0402	Murata LQG series	Input Matching/DC Block
L2	1.8	nH	0402	Murata LQG series	Output Matching/DC Block
R1	39	kΩ	0402	Various	Base current settings
R2	0	Ω	0402	Various	Jumper
R3	5.1	Ω	0402	Various	Collector current settings
R4	7.5	Ω	0402	Various	Output Matching/ Stability improvement
M1			0.2x0.5mm		Emitter degeneration FR4 substrate
Q	BFP720FESD		TSFP-4	Infineon Technologies	SiGe C: bipolar transistor



## 4 Typical Measurement Results

**Table 3 Summary of Measurement results for WiMAX/WLAN 2.3-2.7GHz (at room temperature)**

$V_{cc}=2.8V$ ,  $I_{cc}=12mA$ ,  $freq=2300...2700MHz$

Parameter	Symbol	Value	Unit	Comment/Test Condition
Frequency Range	Freq	2300...2700	MHz	
DC Voltage	Vcc	2.8	V	
DC Current	Icc	12.0	mA	
Gain	G	17.5	dB	
Noise Figure	NF	1.3	dB	
Input Return Loss	RLin	18.0	dB	Input Power Pin=-30 dBm
Output Return Loss	RLout	8.0	dB	
Reverse Isolation	IRev	30.0	dB	
Input P1dB	IP1dB	-16.0	dBm	Pin=-30..0dBm. Measured @2.4GHz
Output P1dB	OP1dB	2.0	dBm	
Input IP3	IIP3	-8.0	dBm	
Output IP3	OIP3	12.0	dBm	Pin=-40 dBm, f1=2400 MHz, f2=2401 MHz
Switching Time	TsMax	540	ns	Maximum Time between Rise and fall time
Stability	k	>1	--	Unconditionnally stable from 0 to 10 GHz

**Table 4 Summary of Measurement results for WiMAX/WLAN 5-6GHz (at room temperature)**

$V_{cc}=2.8V$ ,  $I_{cc}=12mA$ ,  $freq=5000...6000MHz$

Parameter	Symbol	Value	Unit	Comment/Test Condition
Frequency Range	Freq	5000...6000	MHz	
DC Voltage	Vcc	2.8	V	
DC Current	Icc	12.0	mA	
Gain	G	13.5	dB	
Noise Figure	NF	1.35	dB	
Input Return Loss	RLin	10.0	dB	Input Power Pin=-30 dBm
Output Return Loss	RLout	10.5	dB	
Reverse Isolation	IRev	24.0	dB	
Input P1dB	IP1dB	-8.5	dBm	Pin=-30...0 dBm. Measured @5.5GHz
Output P1dB	OP1dB	4.0	dBm	
Input IP3	IIP3	3.5	dBm	
Output IP3	OIP3	17.0	dBm	Pin=-30 dBm, f1=5500 MHz, f2=5501 MHz
Switching time	TsMax	540	ns	Maximum Time between Rise and fall time
Stability	k	>1	--	Unconditionnally stable from 0 to 10 GHz

Note: the measurements showed in Table 3 and Table 4 are excluding the PCB and SMA losses of 0.15dB.

## 5 Measured graphs from 2.3 to 2.7GHz

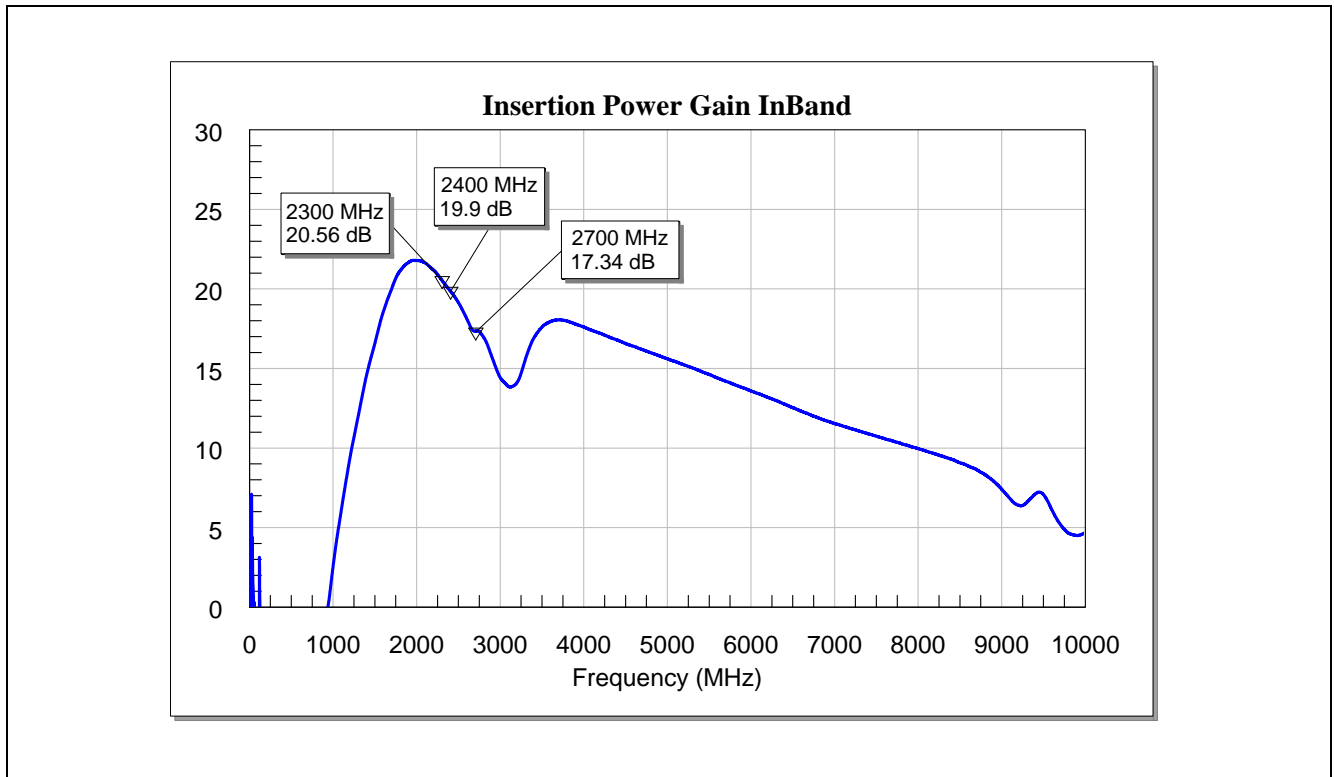

Figure 4 Insertion power gain of the BFP720FESD for WLAN/Wimax at 2.3-2.7GHz

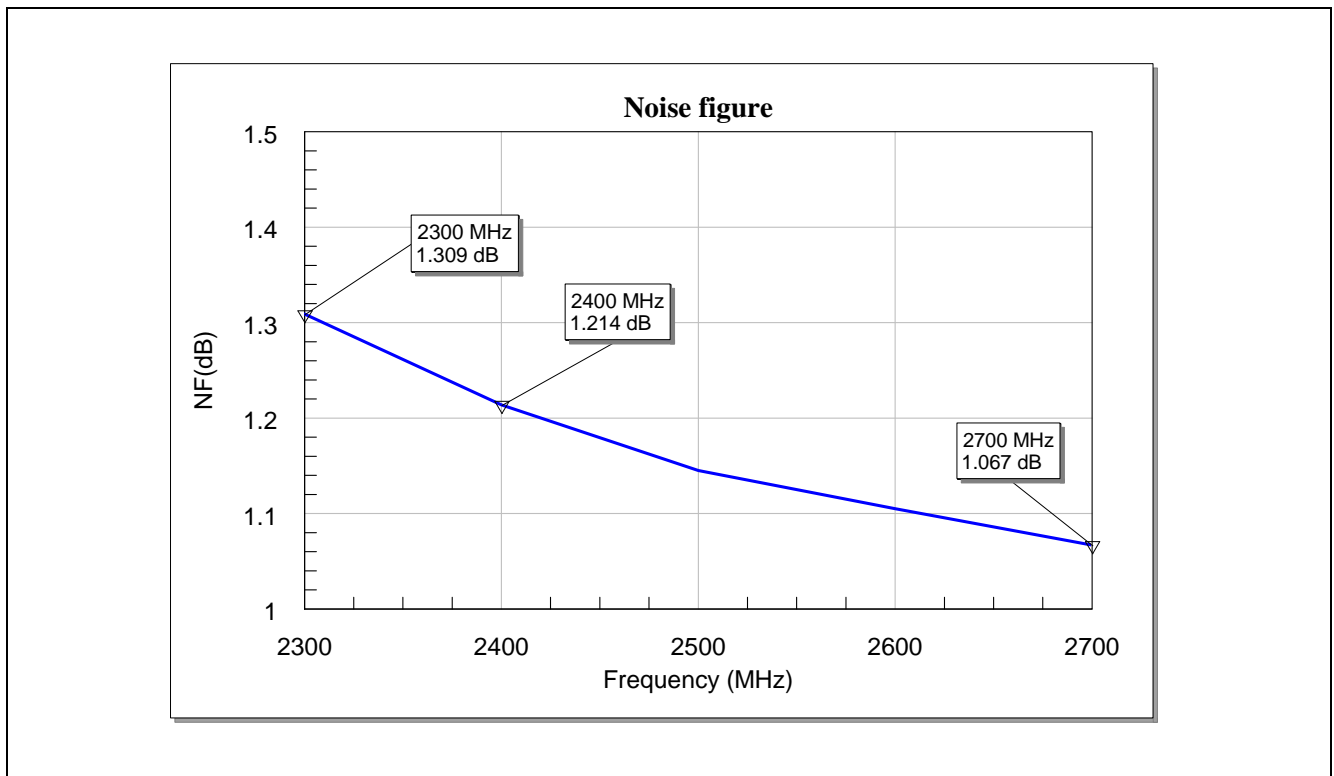
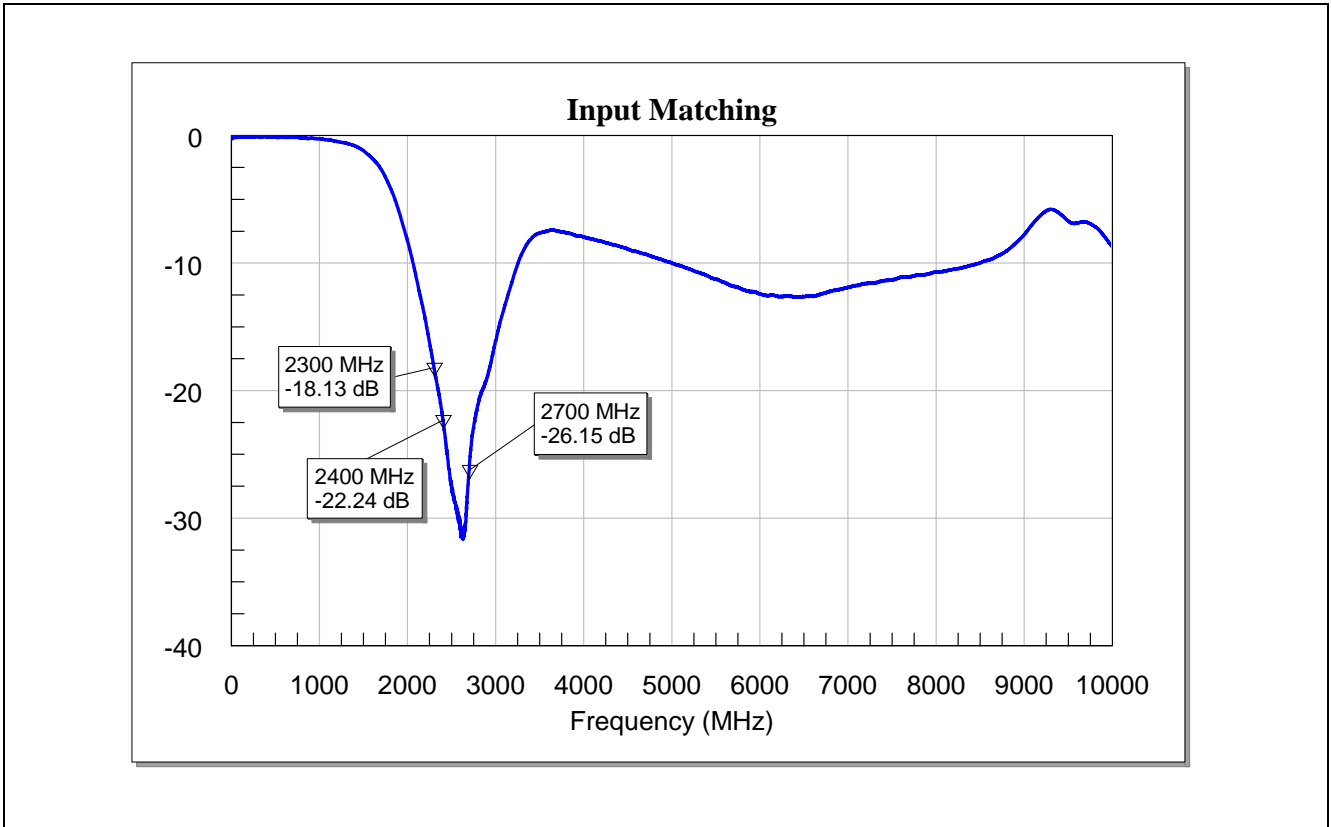
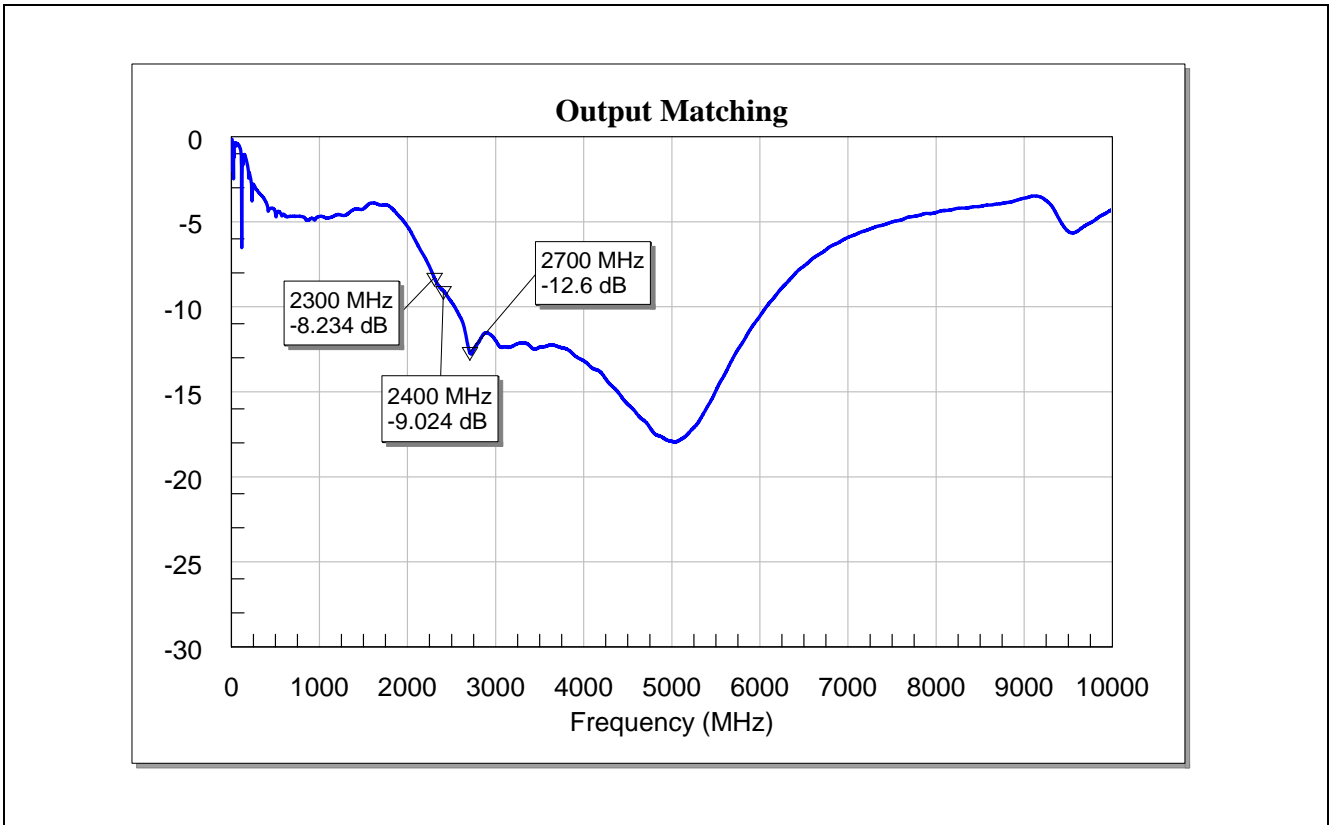

Figure 5 Noise figure of the BFP720FESD for WLAN/Wimax at 2.3-2.7GHz

Measured graphs from 2.3 to 2.7GHz

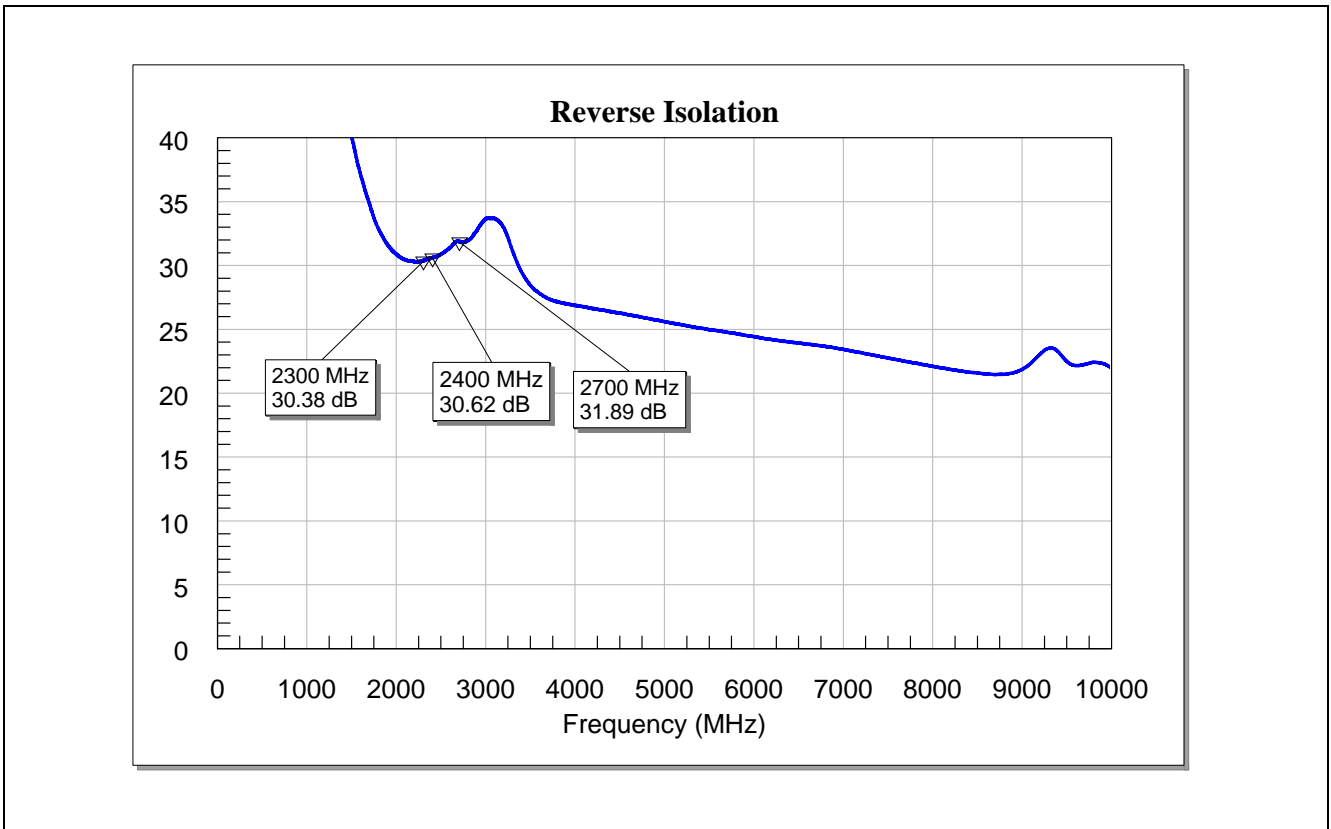

**Figure 6** Input matching of the BFP720FESD for WLAN/Wimax at 2.3-2.7GHz

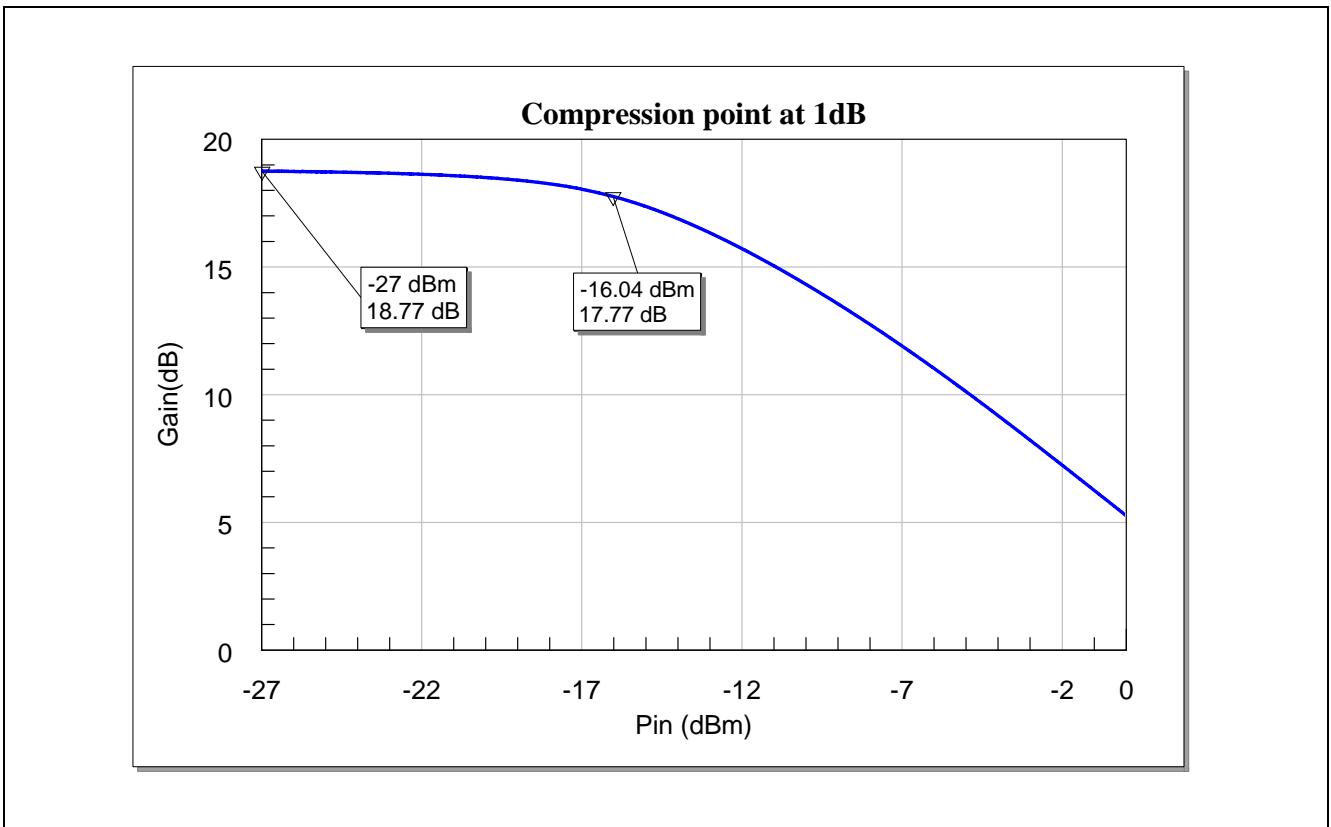

**Figure 7** Output matching of the BFP720FESD for WLAN/Wimax at 2.3-2.7GHz

Measured graphs from 2.3 to 2.7GHz



**Figure 8** Reverse Isolation of the BFP720FESD for WLAN/Wimax at 2.3-2.7GHz



**Figure 9** Input 1dB compression point of the BFP720FESD for WLAN/Wimax at 2.3-2.7GHz

Measured graphs from 2.3 to 2.7GHz

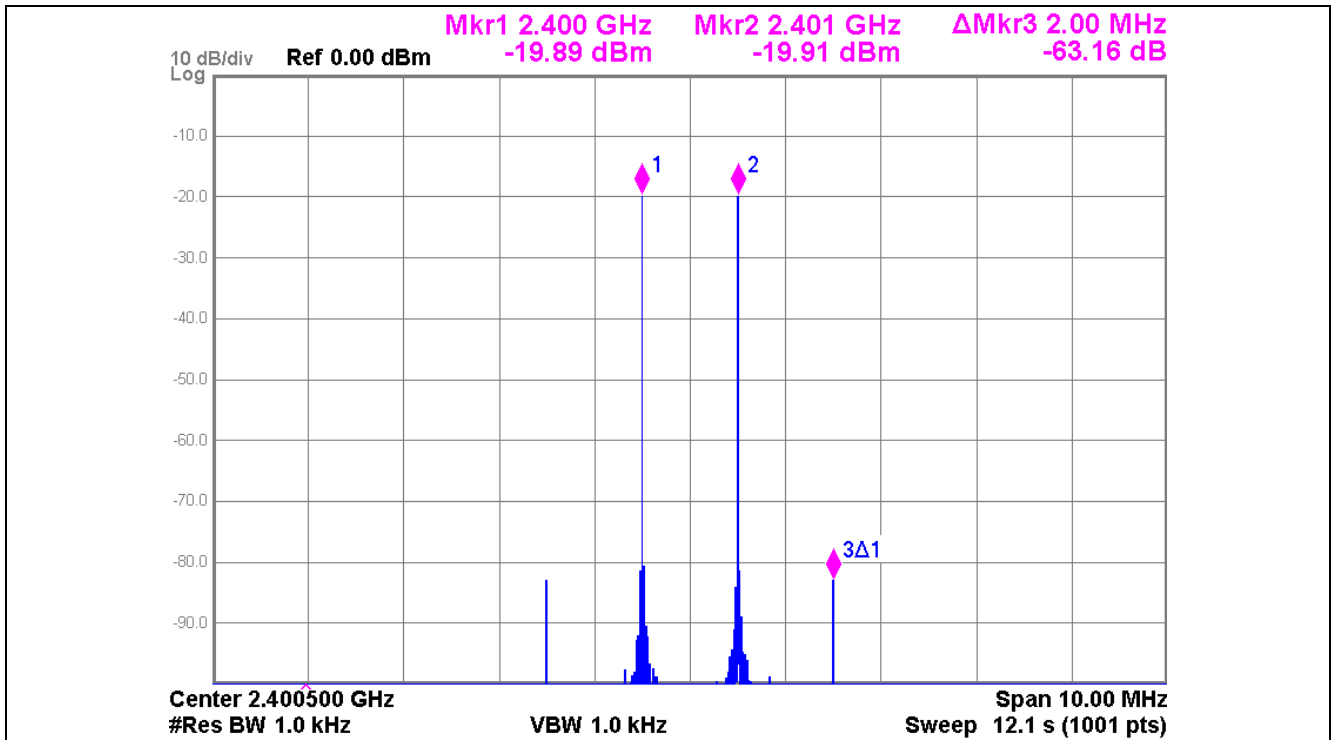

Figure 10 Output 3<sup>rd</sup> order Intercept point of the BFP720FESD for WLAN/Wimax at 2.3-2.7GHz

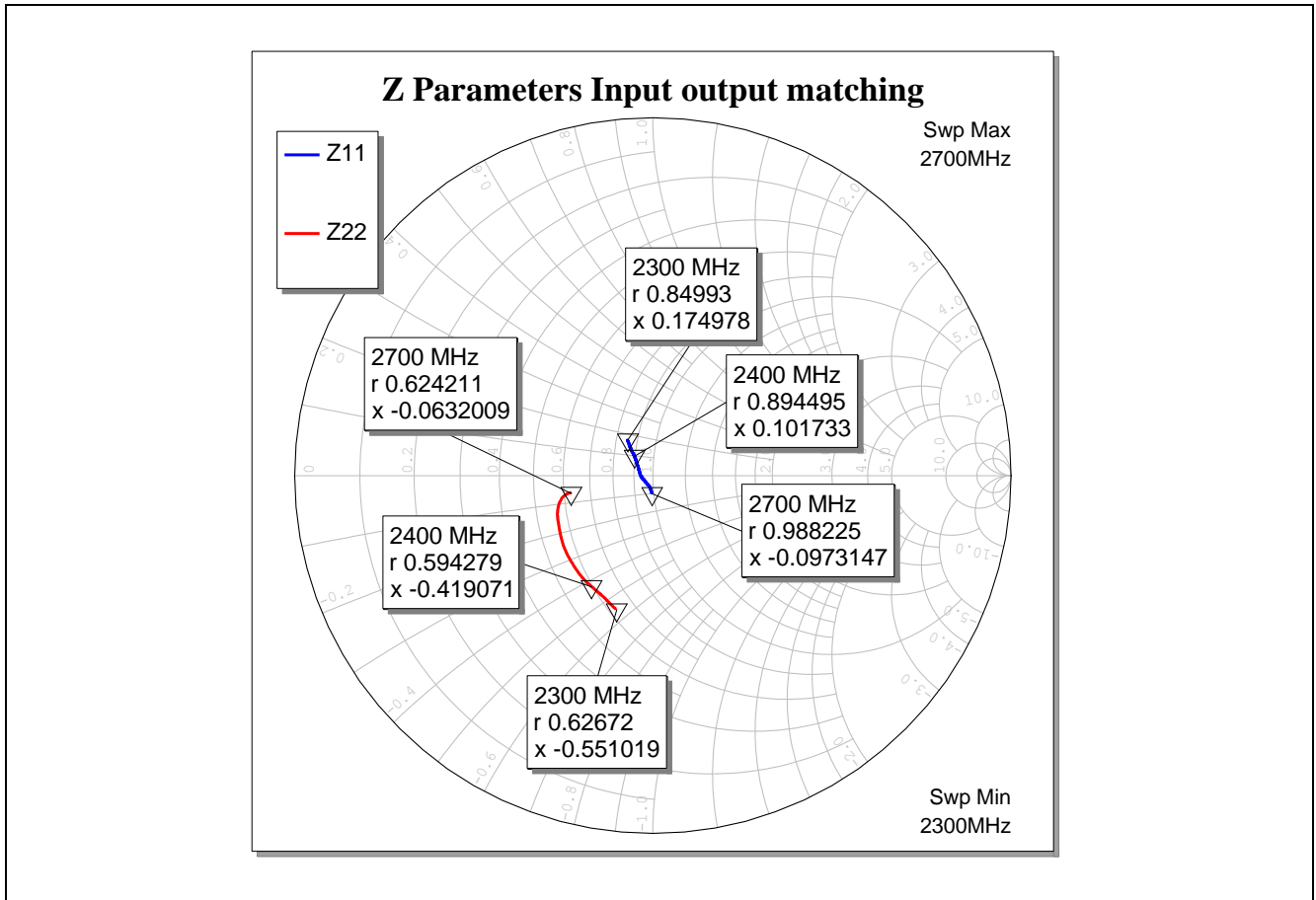
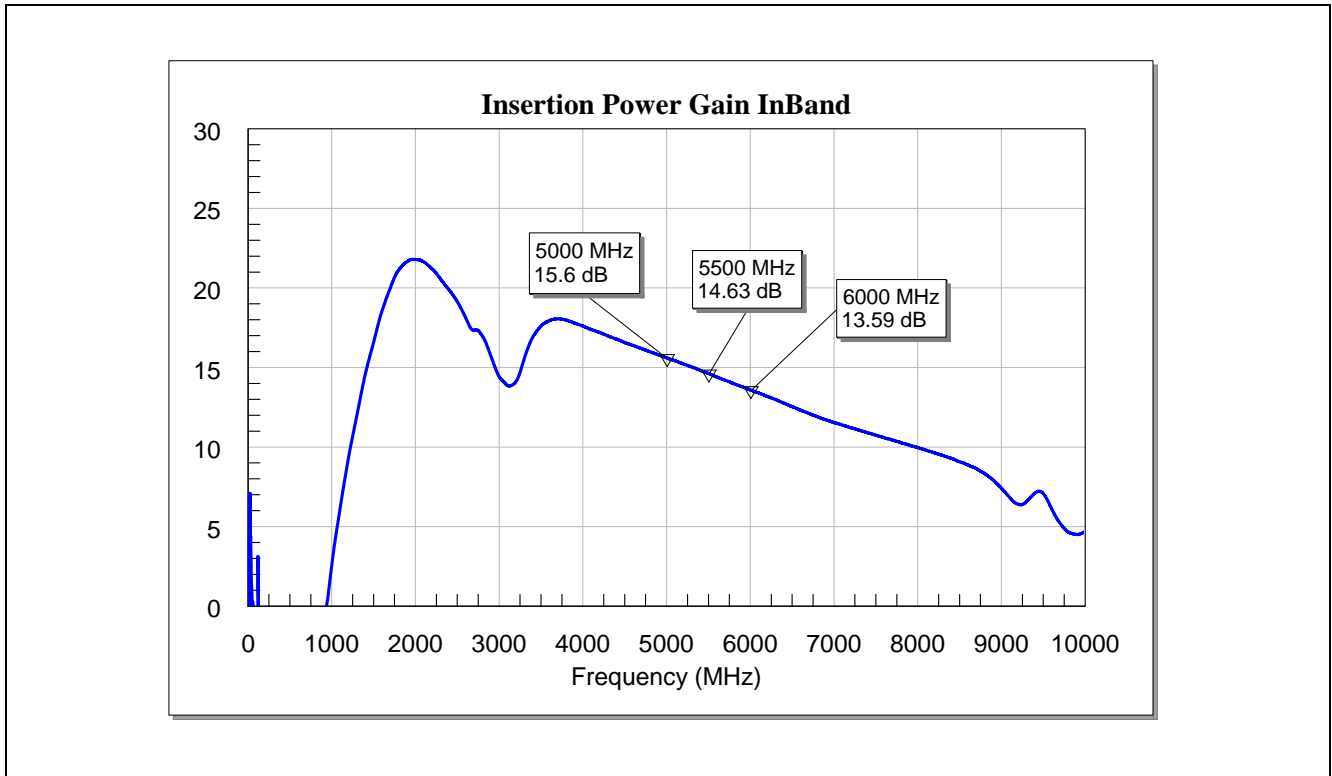
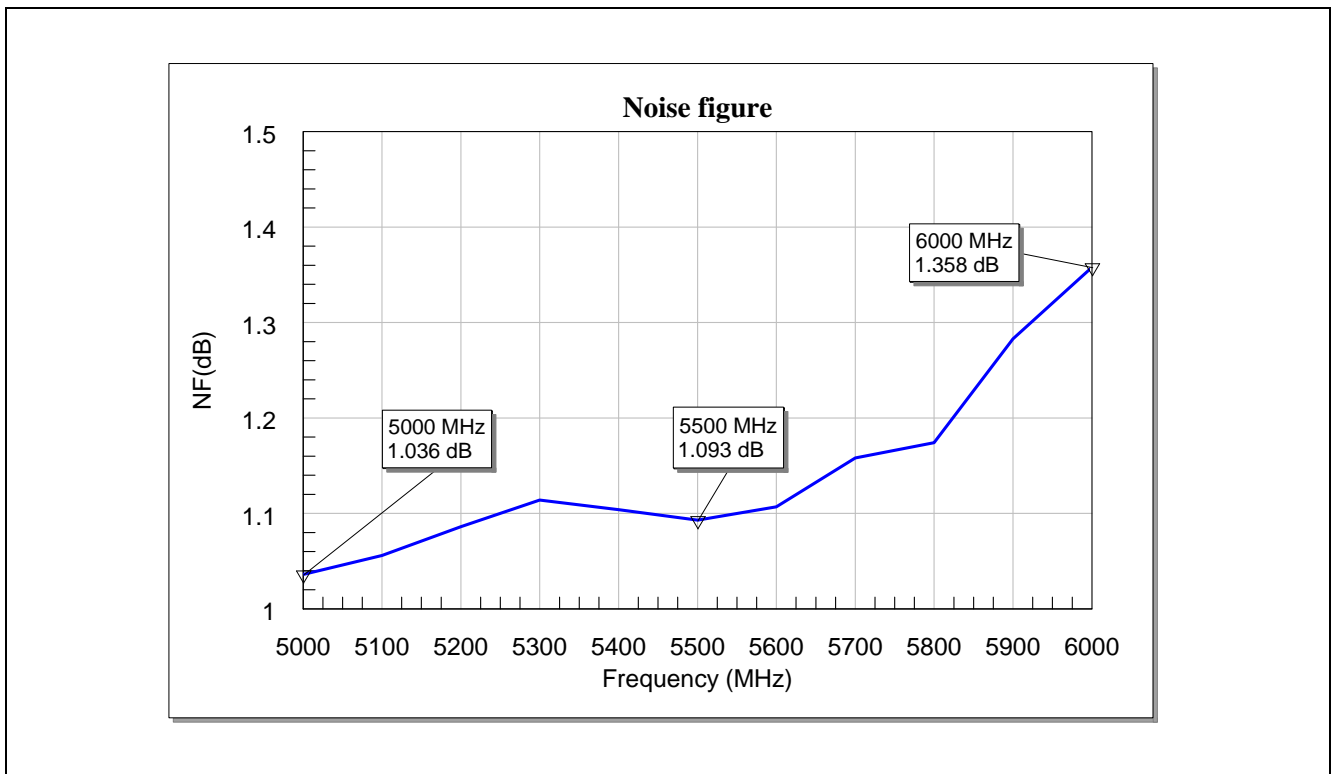

Figure 11 Input and Output impedance of the BFP720FESD for WLAN/Wimax at 2.3-2.7GHz

**6 Measured graphs from 5.0 to 6.0GHz**

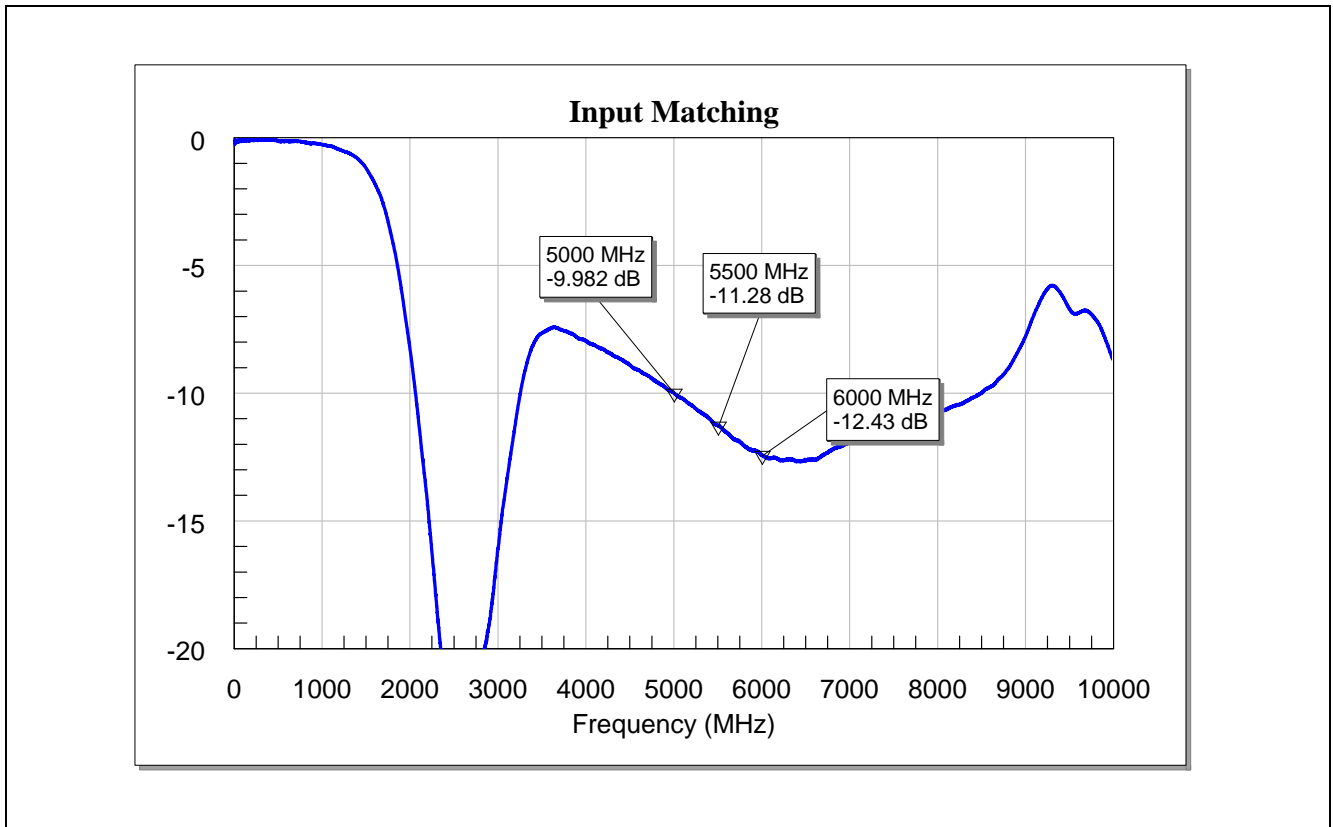

**Figure 12** Insertion power gain of the BFP720FESD for WLAN/Wimax at 5-6GHz

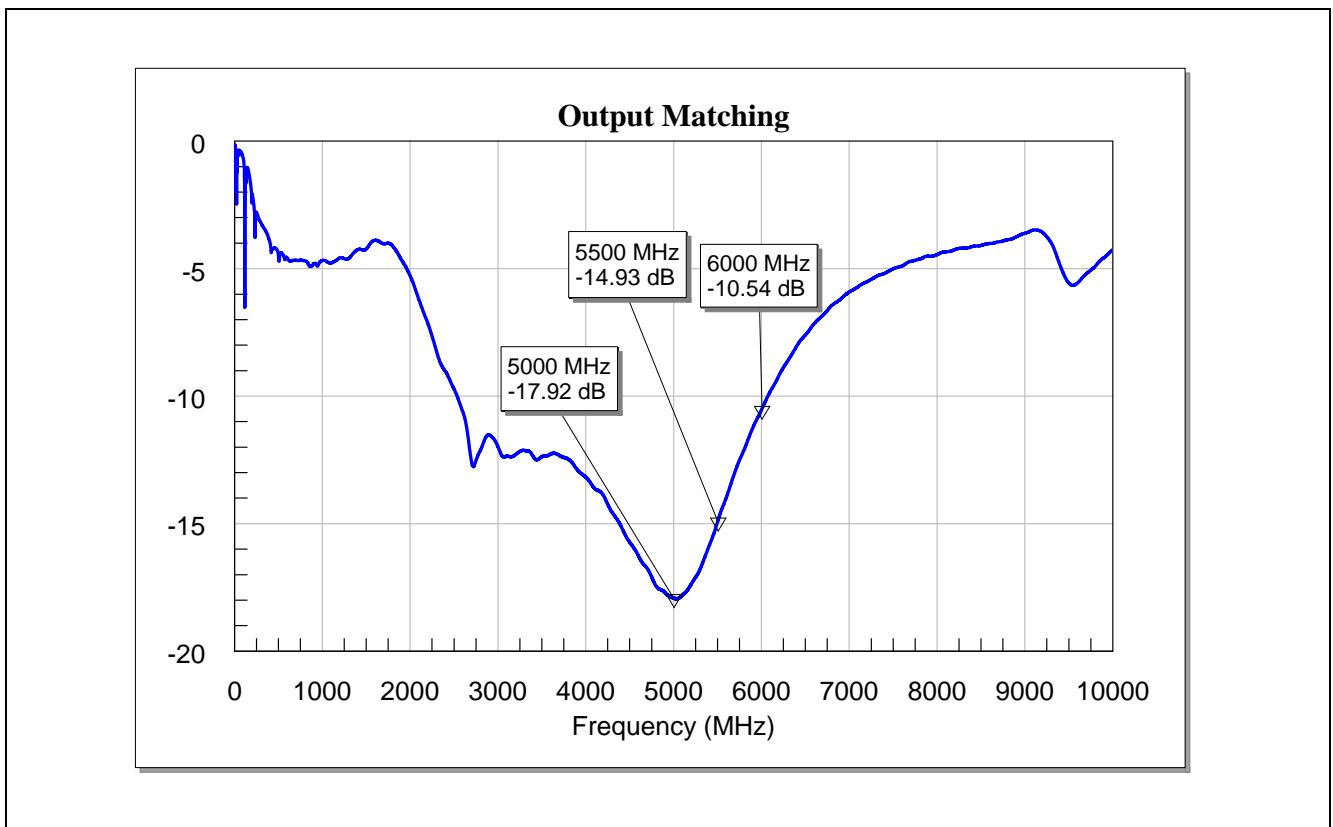

**Figure 13** Noise figure of the BFP720FESD for WLAN/Wimax at 5-6GHz

Measured graphs from 5.0 to 6.0GHz



**Figure 14** Input matching of the BFP720FESD for WLAN/Wimax at 5-6GHz



**Figure 15** Output matching of the BFP720FESD for WLAN/Wimax at 5-6GHz

Measured graphs from 5.0 to 6.0GHz

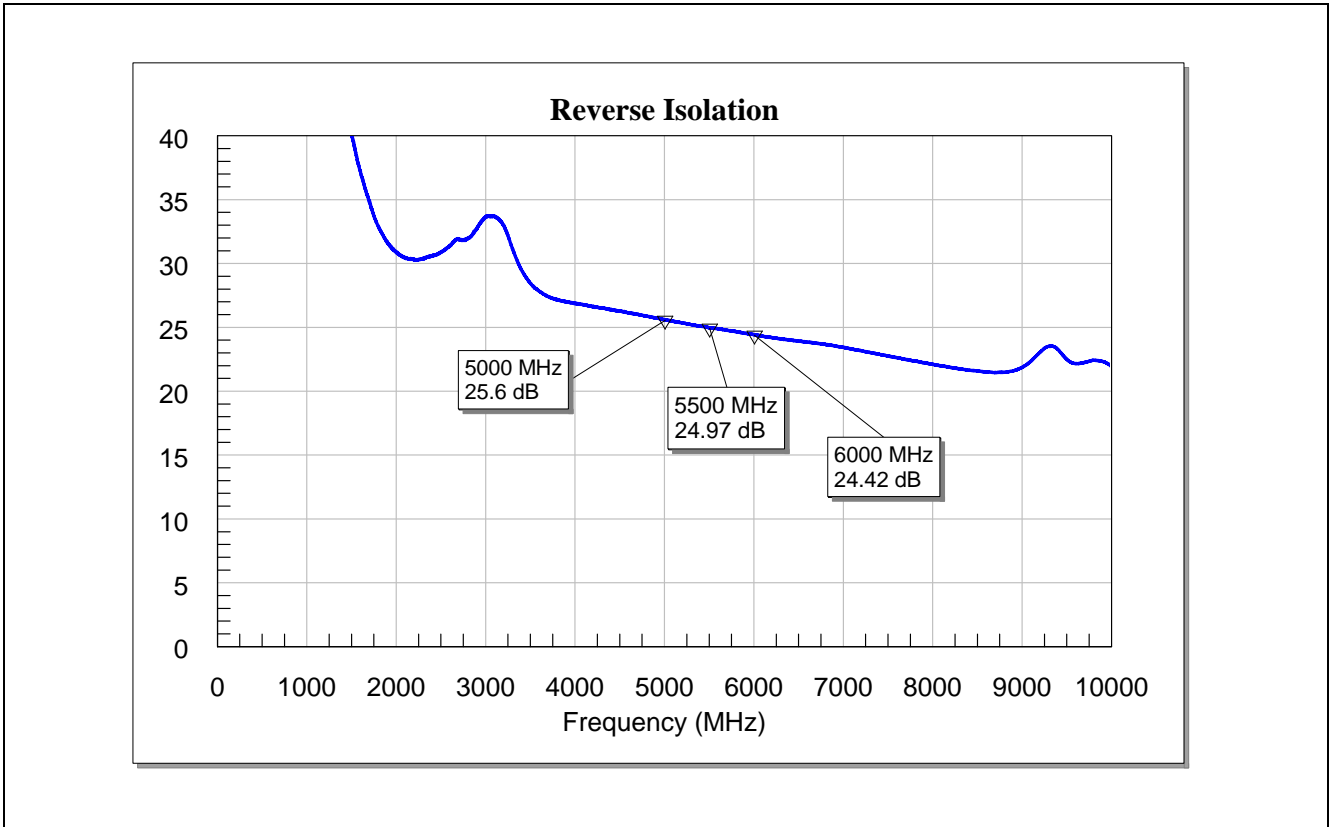

Figure 16 Reverse isolation of the BFP720FESD for WLAN/Wimax at 5-6GHz

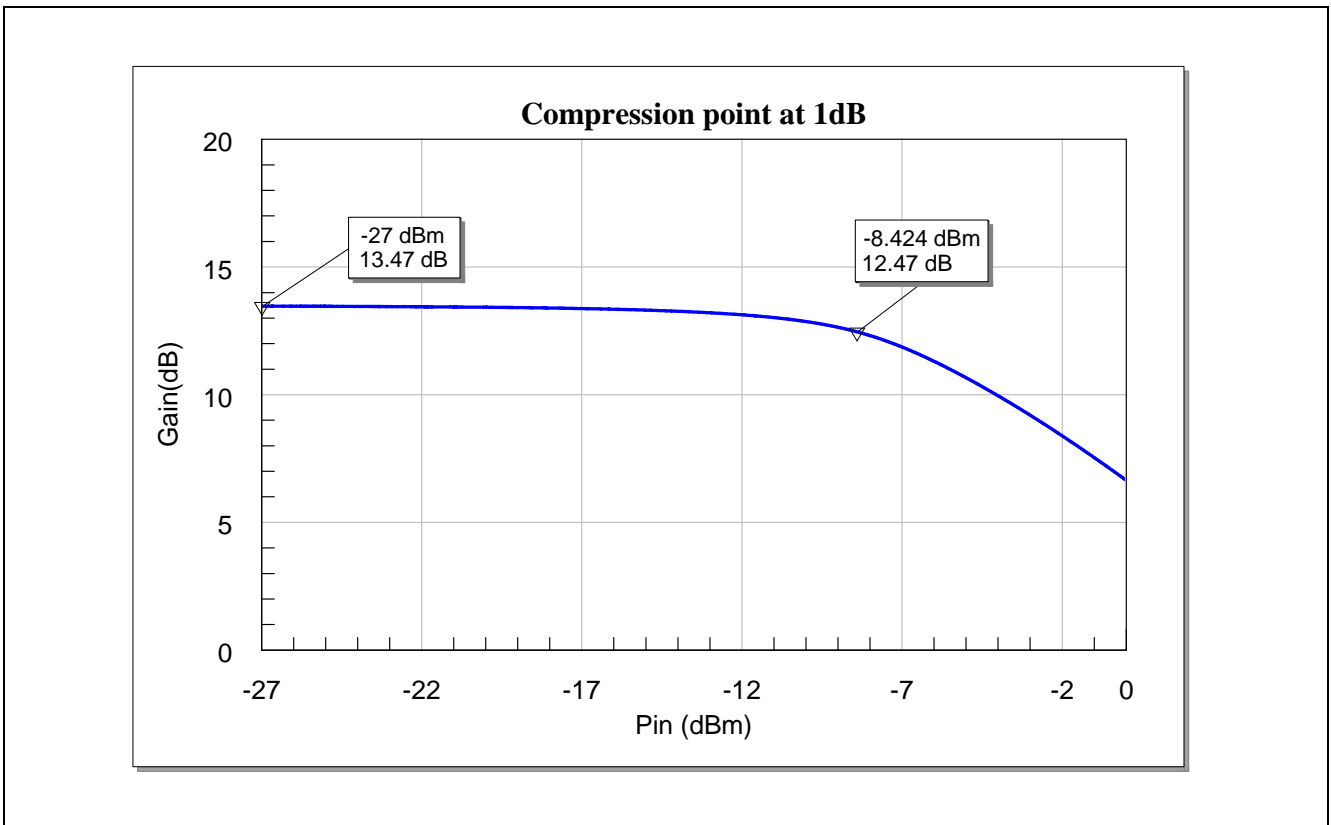

Figure 17 Input 1dB compression point of the BFP720FESD for WLAN/Wimax at 5-6GHz



Measured graphs from 5.0 to 6.0GHz

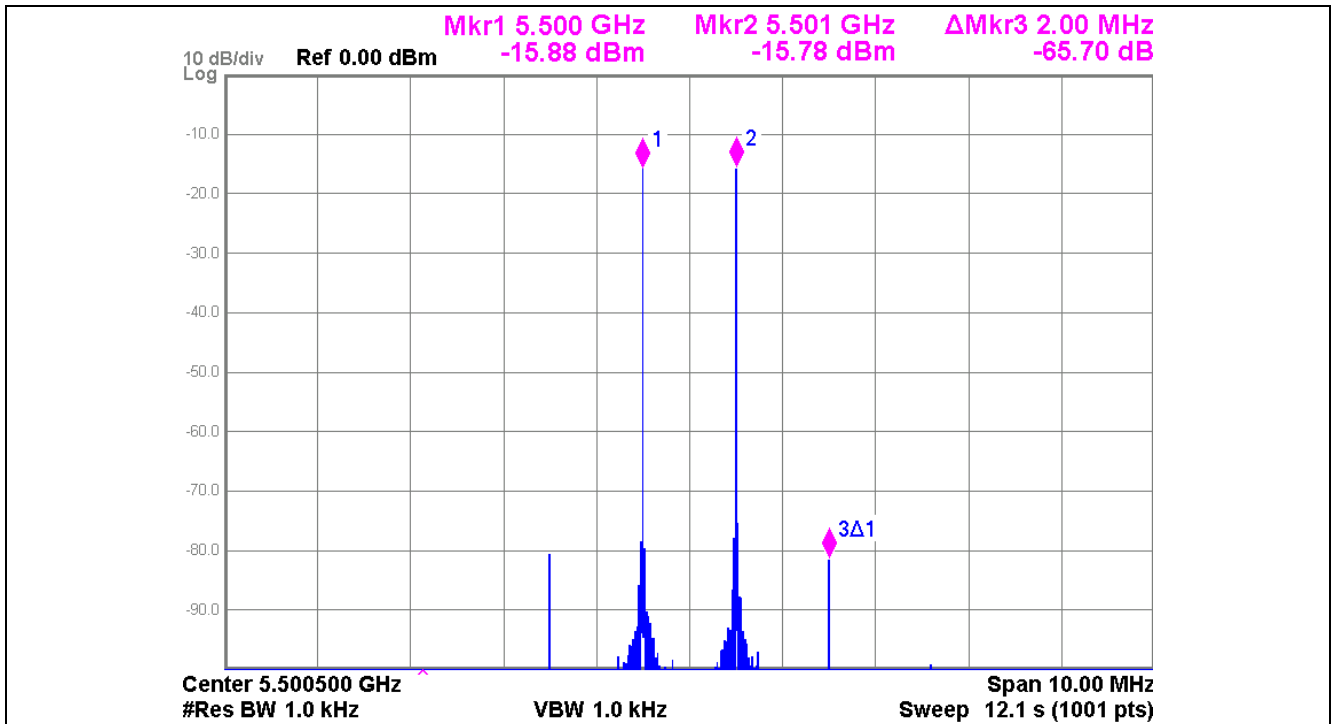

Figure 18 Output 3<sup>rd</sup> order intercept point of the BFP720FESD for WLAN/Wimax at 5-6GHz

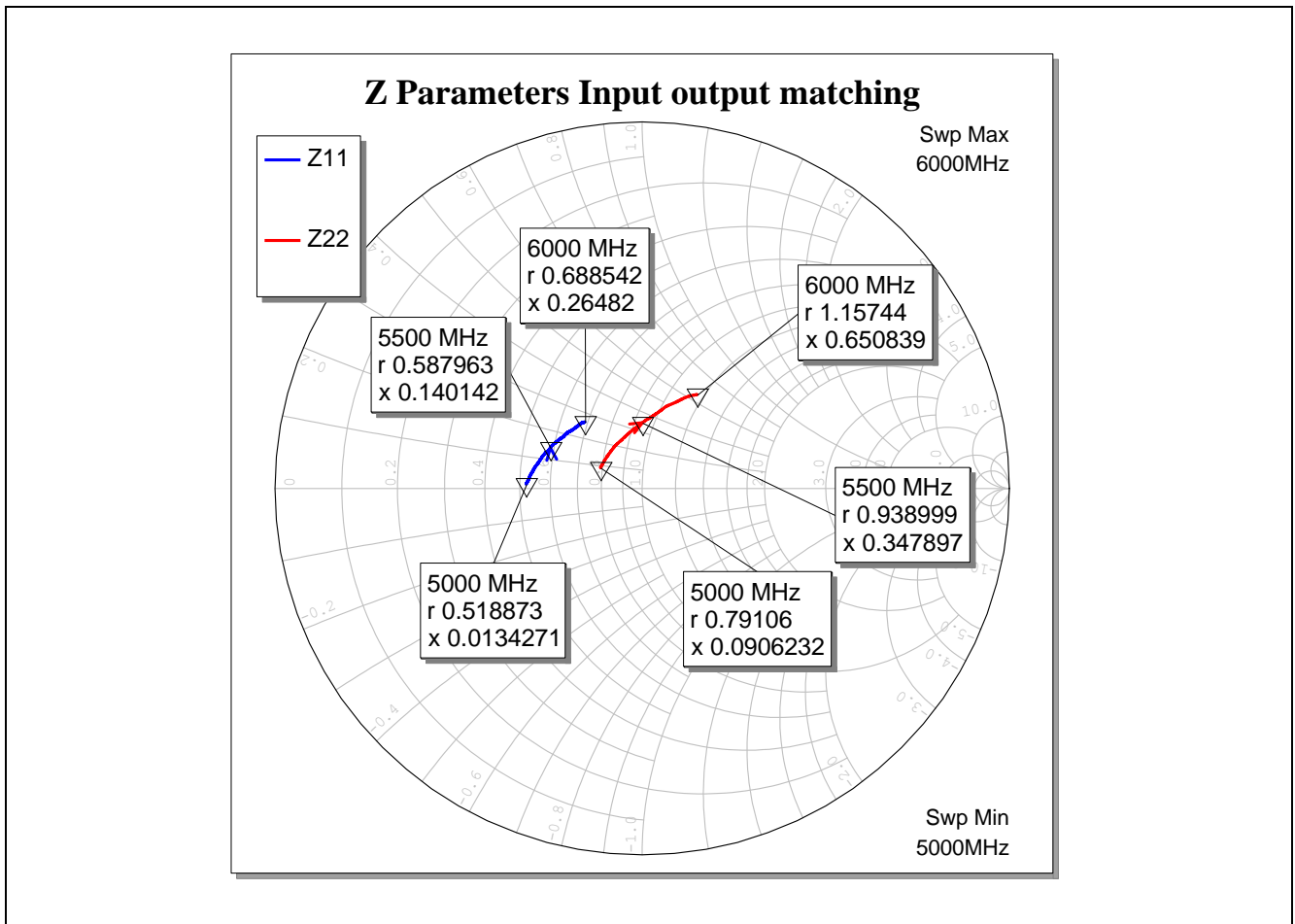
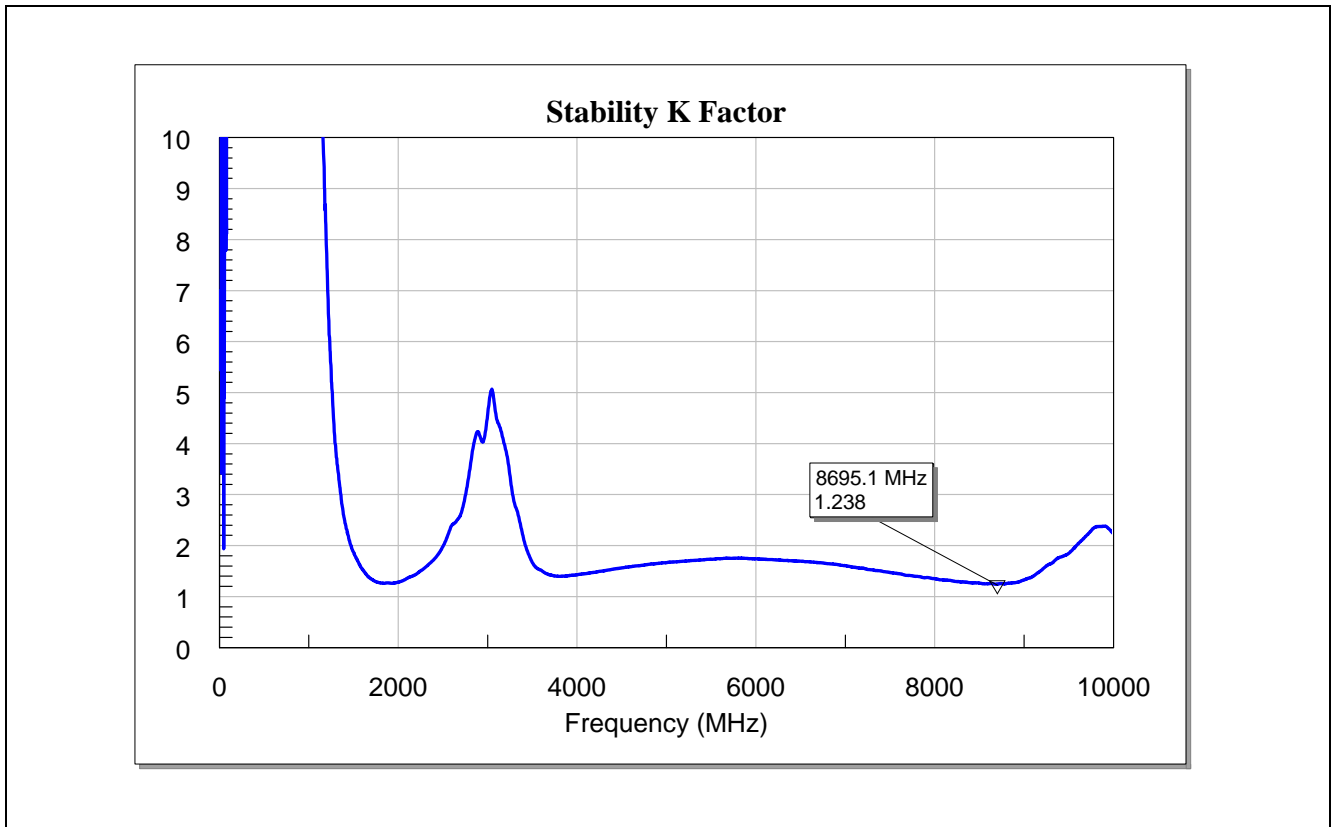
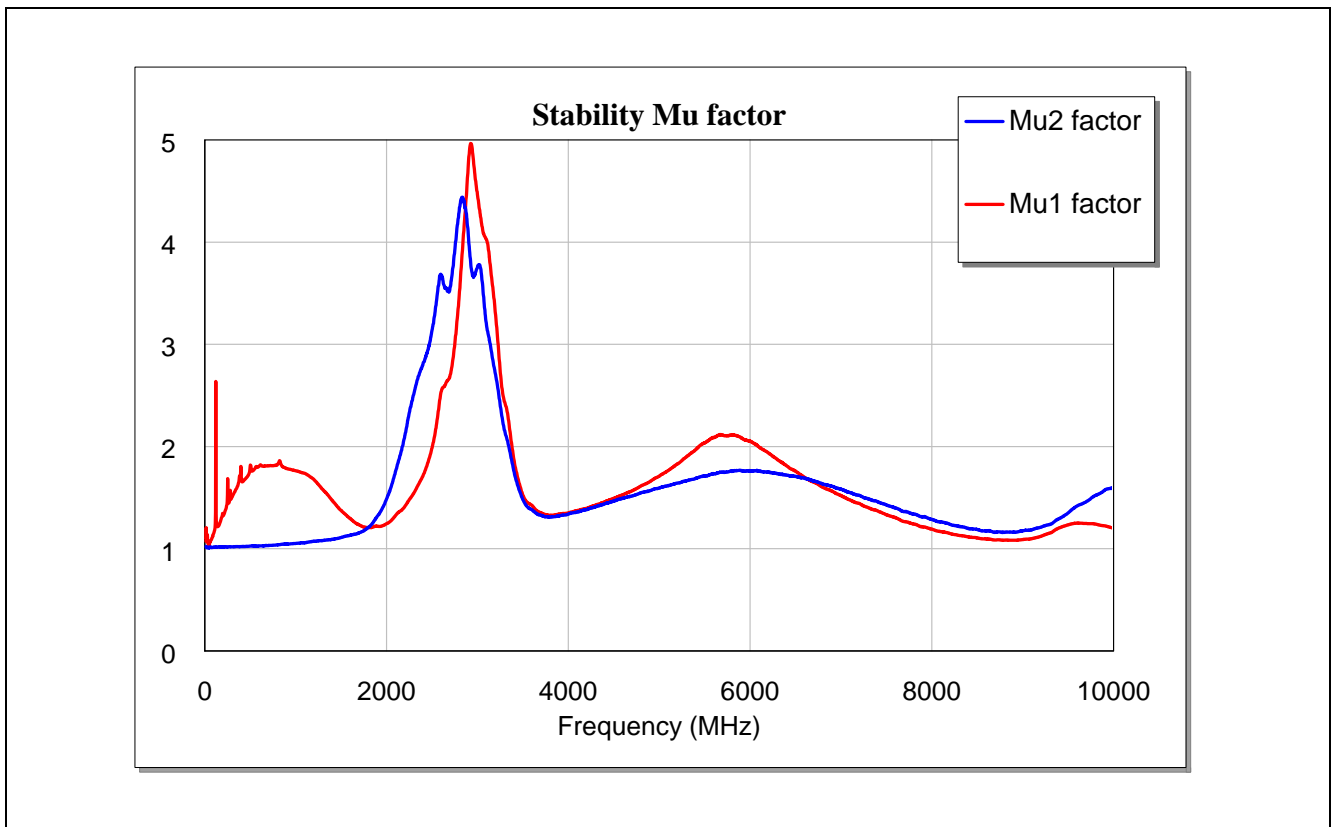

Figure 19 Input and Output impedance of the BFP720FESD for WLAN/Wimax at 5-6GHz

Measured graphs from 5.0 to 6.0GHz



**Figure 20** K-factor stability of the BFP720FESD for WLAN/Wimax 2.3-2.7&5-6GHz applications



**Figure 21**  $\mu$ -factor stability of the BFP720FESD for WLAN/Wimax 2.3-2.7&5-6GHz applications

Measured graphs from 5.0 to 6.0GHz

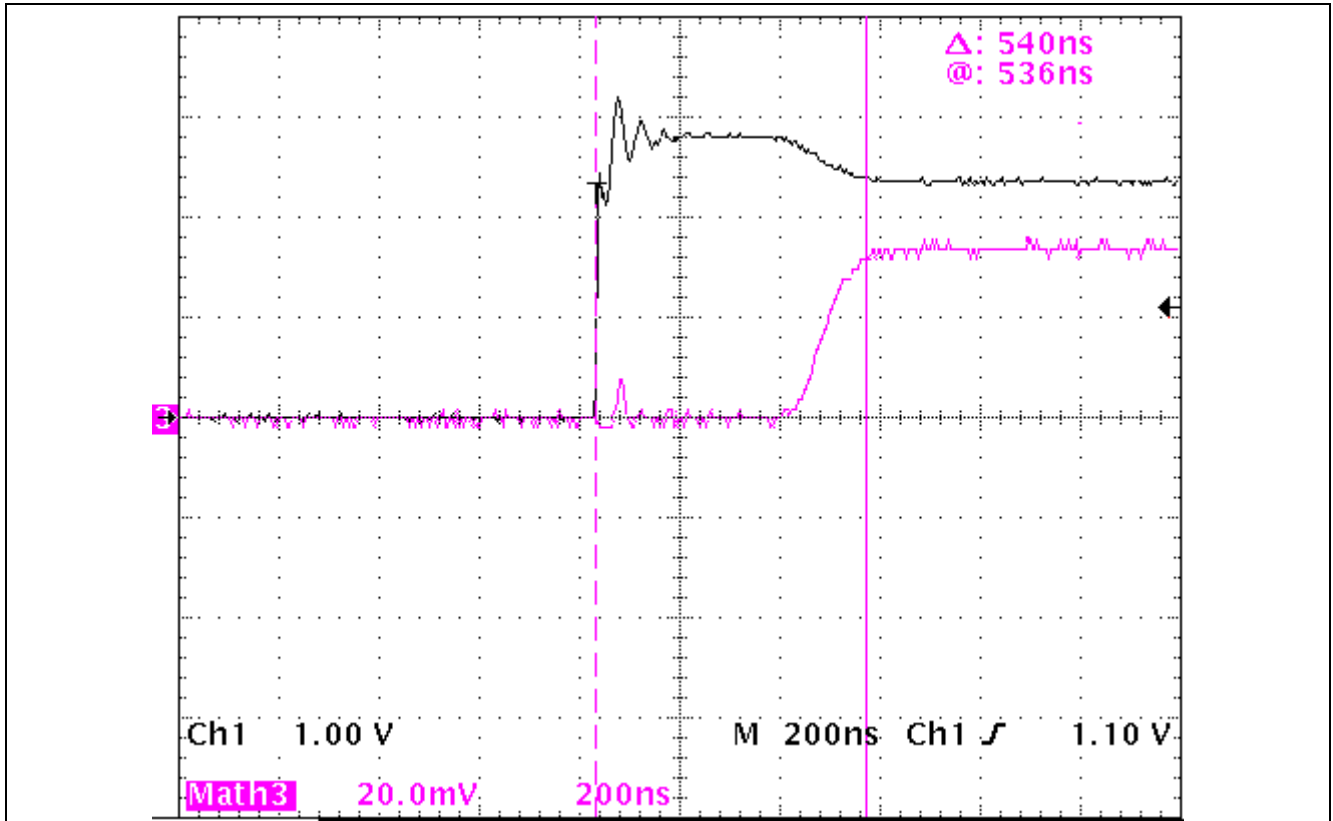

Figure 22 Rise switching time of the BFP720FESD for WLAN/Wimax 2.3-2.7&5-6GHz applications

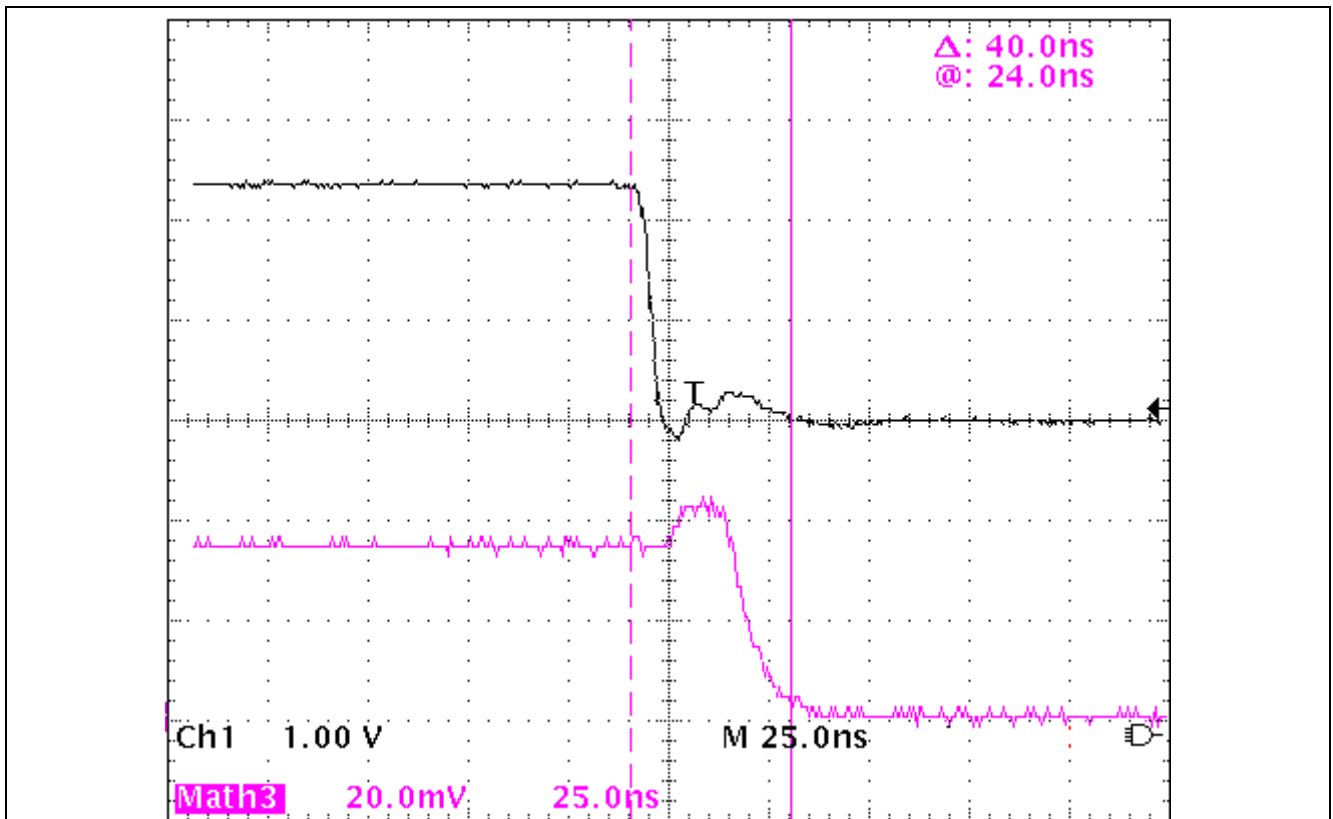
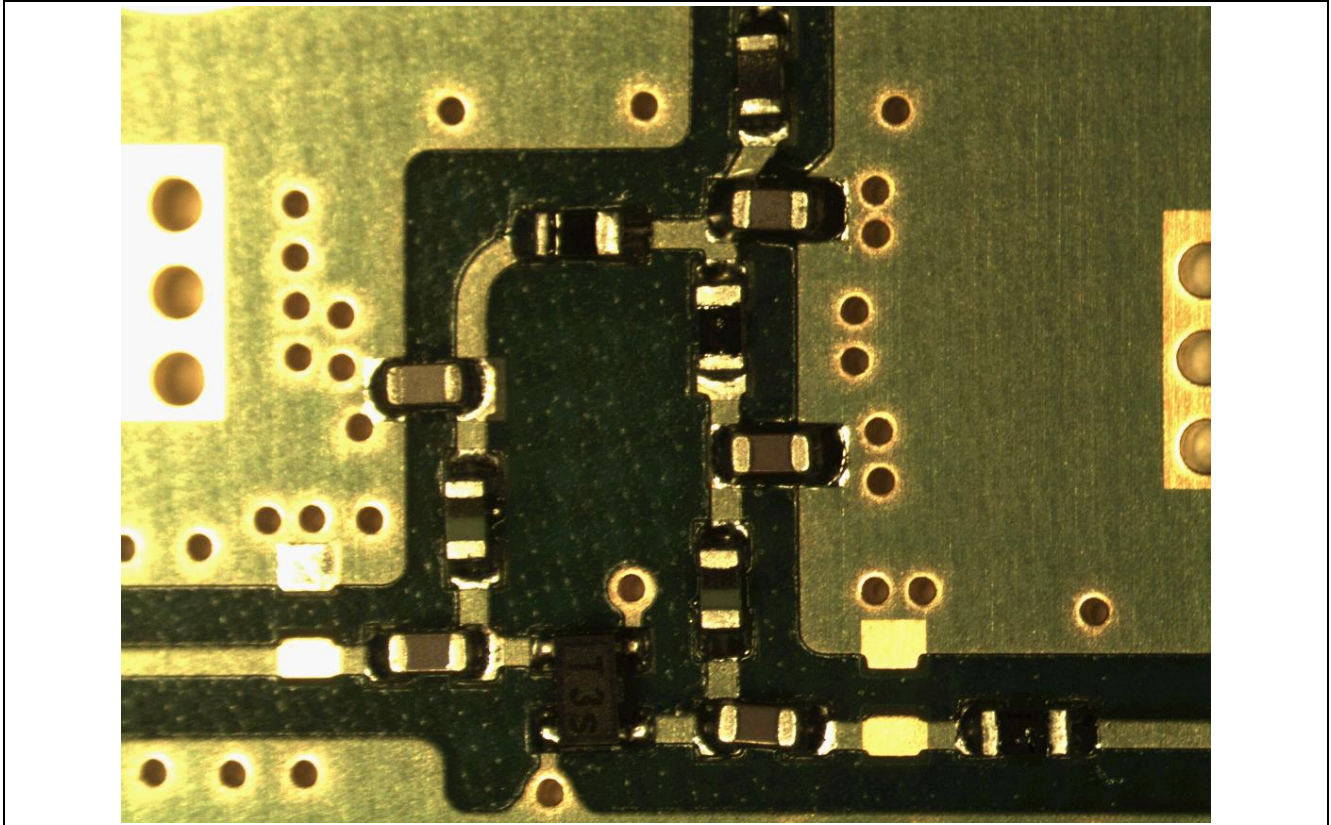
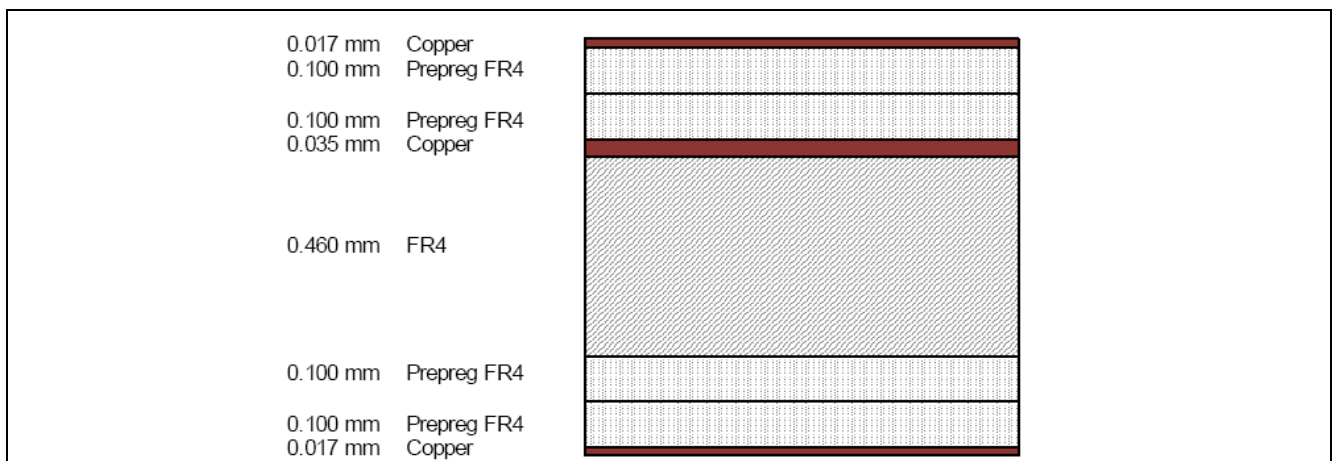

Figure 23 Fall switching time of the BFP720FESD for WLAN/Wimax 2.3-2.7&5-6GHz applications

## 7 Evaluation Board and layout Information



**Figure 24 PCB Picture of Evaluation Board**



**Figure 25 PCB Layer Information**



## **Authors**

Anthony Thomas, RF Application Engineer of Business Unit "RF and Protection Devices"

Dr Chih-i Lin, Senior Staff engineer of Business Unit "RF and Protection Devices"

[www.infineon.com](http://www.infineon.com)