

Application Note No. 149

1.8 V, 2.6 mA Low Noise Amplifier for 1575 MHz
GPS L1 Frequency with the BFP405 RF Transistor

RF & Protection Devices



Never stop thinking

Edition 2008-02-22

**Published by
Infineon Technologies AG
81726 München, Germany**

**© Infineon Technologies AG 2009.
All Rights Reserved.**

LEGAL DISCLAIMER

THE INFORMATION GIVEN IN THIS APPLICATION NOTE IS GIVEN AS A HINT FOR THE IMPLEMENTATION OF THE INFINEON TECHNOLOGIES COMPONENT ONLY AND SHALL NOT BE REGARDED AS ANY DESCRIPTION OR WARRANTY OF A CERTAIN FUNCTIONALITY, CONDITION OR QUALITY OF THE INFINEON TECHNOLOGIES COMPONENT. THE RECIPIENT OF THIS APPLICATION NOTE MUST VERIFY ANY FUNCTION DESCRIBED HEREIN IN THE REAL APPLICATION. INFINEON TECHNOLOGIES HEREBY DISCLAIMS ANY AND ALL WARRANTIES AND LIABILITIES OF ANY KIND (INCLUDING WITHOUT LIMITATION WARRANTIES OF NON-INFRINGEMENT OF INTELLECTUAL PROPERTY RIGHTS OF ANY THIRD PARTY) WITH RESPECT TO ANY AND ALL INFORMATION GIVEN IN THIS APPLICATION NOTE.

Information

For further information on technology, delivery terms and conditions and prices please contact your nearest Infineon Technologies Office (www.infineon.com).

Warnings

Due to technical requirements components may contain dangerous substances. For information on the types in question please contact your nearest Infineon Technologies Office.

Infineon Technologies Components may only be used in life-support devices or systems with the express written approval of Infineon Technologies, if a failure of such components can reasonably be expected to cause the failure of that life-support device or system, or to affect the safety or effectiveness of that device or system. Life support devices or systems are intended to be implanted in the human body, or to support and/or maintain and sustain and/or protect human life. If they fail, it is reasonable to assume that the health of the user or other persons may be endangered.

Application Note No. 149

Revision History: 2008-02-22, Rev. 1.2

Previous Version: 2005-09-23, Rev. 1.1

Page	Subjects (major changes since last revision)
All	Small changes in figure descriptions

1.8 V, 2.6 mA Low Noise Amplifier for 1575 MHz GPS L1 Frequency with the

1 1.8 V, 2.6 mA Low Noise Amplifier for 1575 MHz GPS L1 Frequency with the BFP405 RF Transistor

Overview

- The low emitter-area BFP405 RF Transistor in SOT343 package is shown in a low-cost, low-power consumption LNA targeted for systems having a 1.8 V voltage regulator.
- Standard, low-cost "0402" size passives are used. Total PCB area needed is 50 mm²; total parts count, including the BFP405F transistor, is 12 pieces.
- Printed Circuit Board used is Infineon Part Number 640-061603 Rev A. Standard FR4 material is used in a three-layer PCB. See cross-sectional diagram below.
- The amplifier is unconditionally stable from 5 MHz to 8 GHz.

Summary of Results

$T = 25\text{ }^{\circ}\text{C}$, Network Analyzer Source Power $\approx -25\text{ dBm}$, $V_{CC} = 1.8\text{ V}$, $V_{CE} = 1.5\text{ V}$, $I_C = 2.6\text{ mA}$, $Z_S = Z_L = 50\ \Omega$.

Table 1 Summary of Results

Frequency MHz	dB [s11] ²	dB [s21] ²	dB [s12] ²	dB [s22] ²	NF* dB	IIP ₃ dBm	OIP ₃ dBm	IP _{1dB} dBm	OP _{1dB} dBm
1575	9.6	15.3	26.6	9.6	1.6	-5	+10.3	-23.0	-8.7

* PCB loss is not extracted, e-g- reference plane of measurement is at PCB input RF SMA connector. If PCB loss were extracted, noise figure would improve by 0.1 - 0.2 dB, e.g. NF result would be lower / better.

PCB Cross - Section Diagram

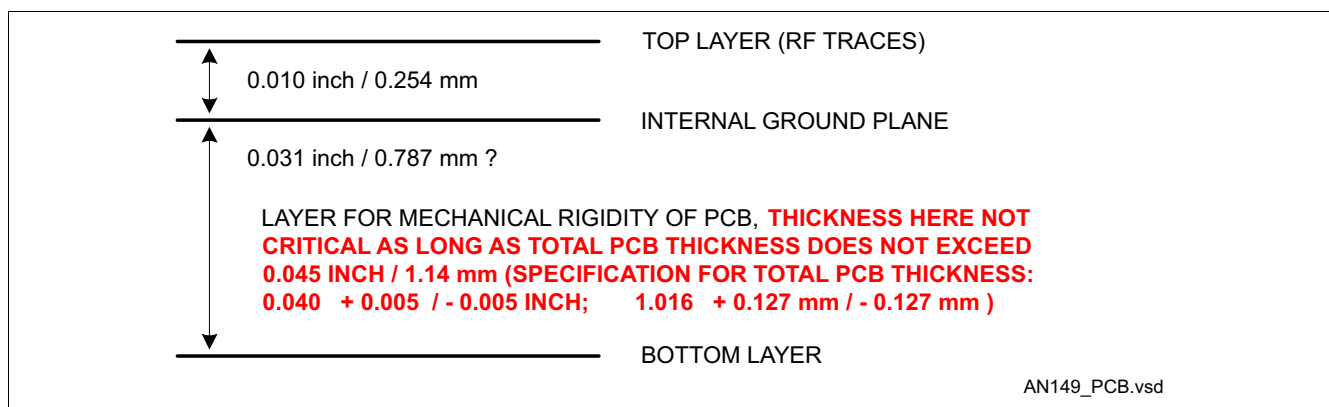

Figure 1 PCB - Cross Sectional Diagram

1.8 V, 2.6 mA Low Noise Amplifier for 1575 MHz GPS L1 Frequency with the

Schematic Diagram

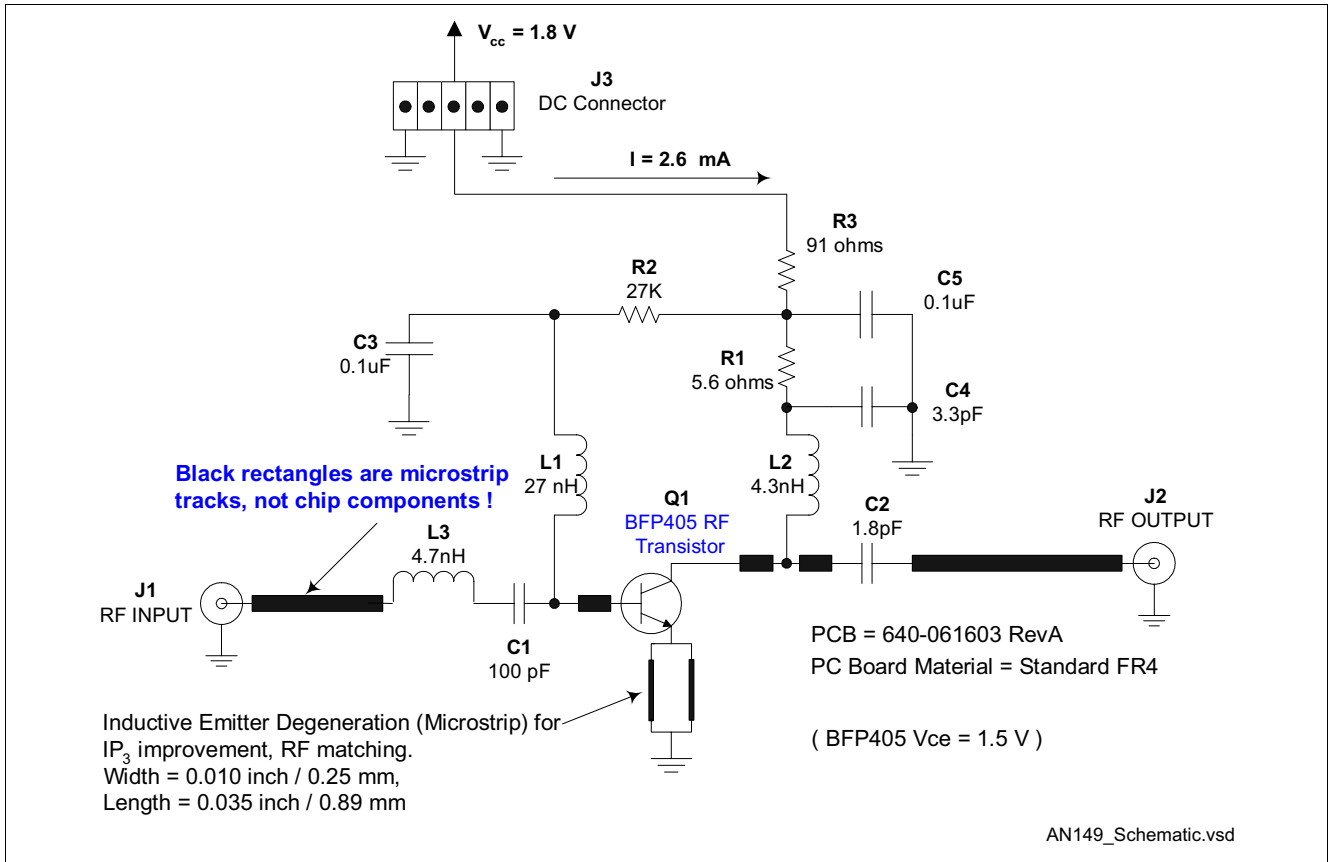

Figure 2 Schematic Diagram

1.8 V, 2.6 mA Low Noise Amplifier for 1575 MHz GPS L1 Frequency with the

Bill of Material

Table 2 Bill of Material

Designator	Value	Manufacturer	Case Size	Function
C1	100 pF	Various	0402	DC blocking, input. Using above SRF also provides some net inductance.
C2	1.8 pF	Various	0402	DC block, output. Also influences output and input match.
C3	0.1 μ F	Various	0402	Decoupling, low frequency. Also improves Third Order Intercept.
C4	3.3 pF	Various	0402	Decoupling, high frequency. Also influences stability and output match.
C5	0.1 μ F	Various	0402	Low frequency decoupling.
L1	27 nH	Murata LQP15M series	0402	RF choke at input, bring in DC bias to base.
L2	4.3 nH	Murata LQP15M series	0402	RF choke at output, influences matching.
L3	4.7 nH	Murata LQP15M series	0402	Input impedance matching.
R1	5.6 Ω	Various	0402	RF stability aid.
R2	27 k Ω	Various	0402	Sets DC operating point (DC bias).
R3	91 Ω	Various	0402	Sets DC operating point and provides some negative DC feedback to stabilize DC operating point over lot-to-lot variations in device DC current gain, also helps to stabilize DC operating point over temperature.
Q1	-	Infineon Technologies	SOT343	BFP405 RF Transistor, B6HF process
J1, J2	-	Johnson 142-0701-841	-	RF input / output connectors
J3	-	AMP 5 pin header MTA-100 series 640456-5 (standard pin plating) or 641215-5 (gold plated pins)	-	DC connector Pins 1, 5 = ground Pin 3 = V_{CC} Pins 2, 4 = no connection

1.8 V, 2.6 mA Low Noise Amplifier for 1575 MHz GPS L1 Frequency with the

Noise Figure, Plot. Center of Plot (x-axis) is 1575 MHz.

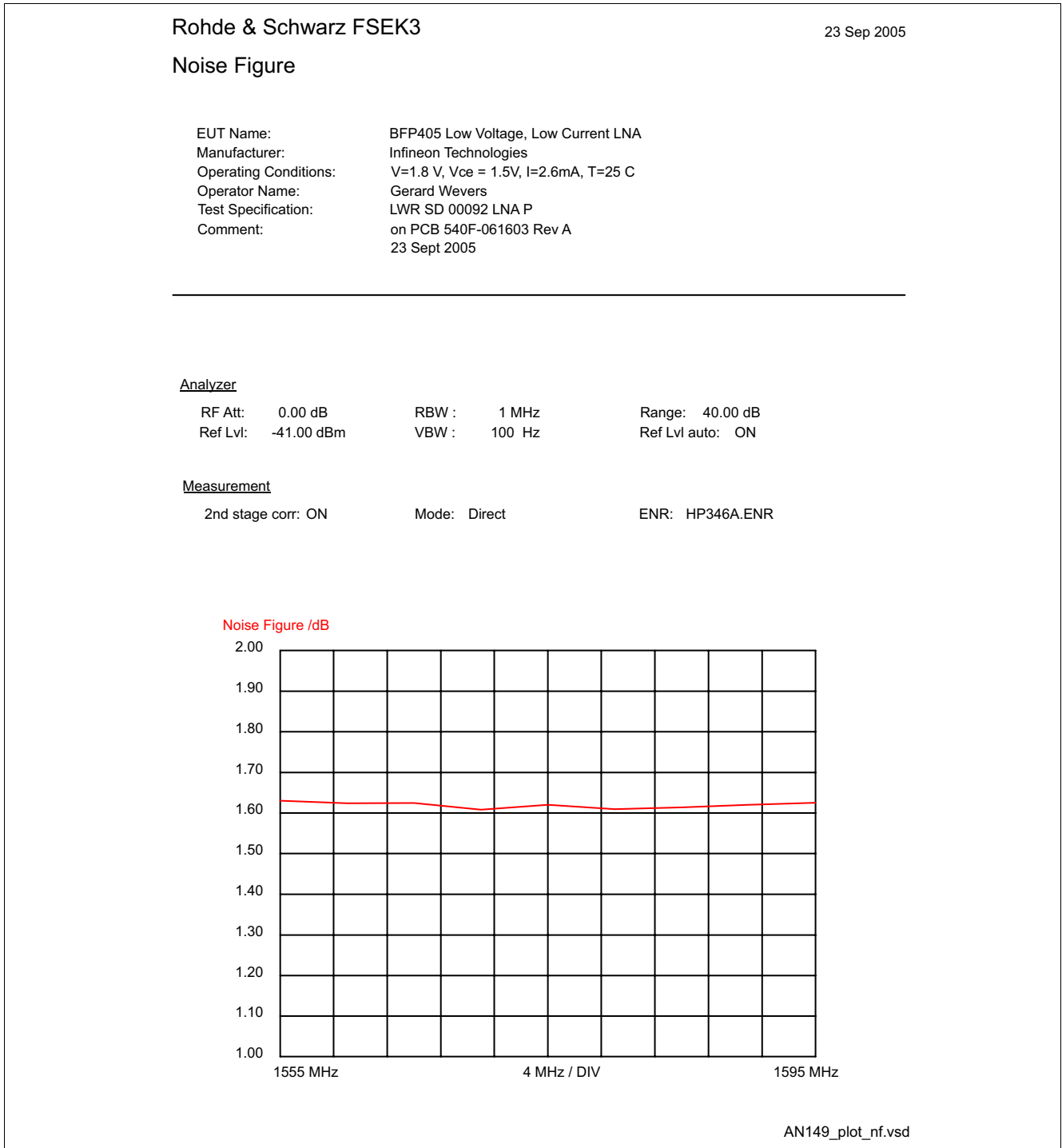

Figure 3 Noise Figure

1.8 V, 2.6 mA Low Noise Amplifier for 1575 MHz GPS L1 Frequency with the**Noise Figure, Tabular Data**

From Rohde & Schwarz FSEK3 + FSEM30 + System Preamplifier
System Preamplifier = MITEQ SMC-02

Table 3 Noise Figure

Frequency	Noise Figure
1555 MHz	1.63 dB
1560 MHz	1.62 dB
1565 MHz	1.62 dB
1570 MHz	1.61 dB
1575 MHz	1.62 dB
1580 MHz	1.61 dB
1585 MHz	1.61 dB
1590 MHz	1.62 dB
1595 MHz	1.63 dB

1.8 V, 2.6 mA Low Noise Amplifier for 1575 MHz GPS L1 Frequency with the

Scanned Image of PC Board

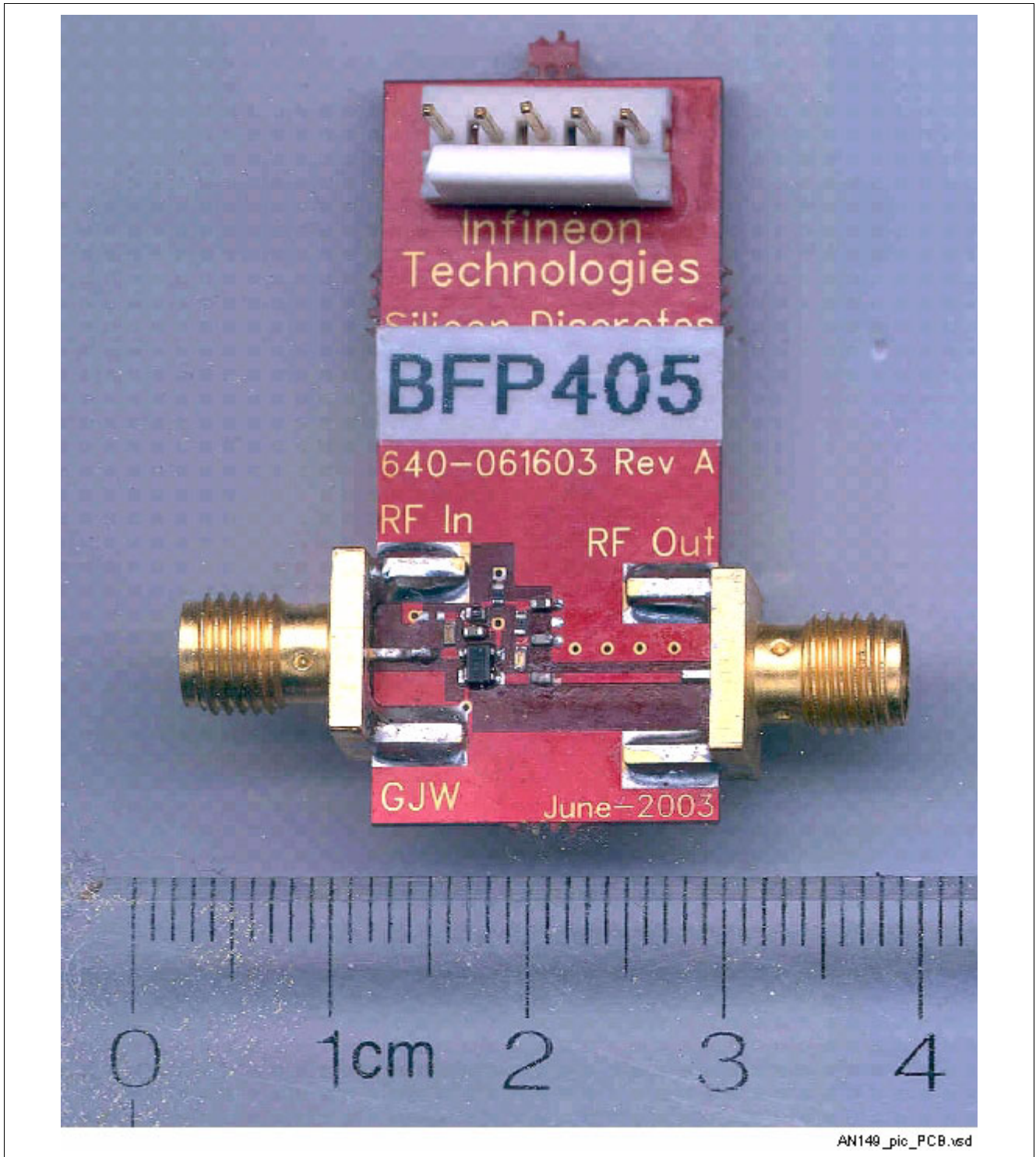

Figure 4 Image of PC Board

1.8 V, 2.6 mA Low Noise Amplifier for 1575 MHz GPS L1 Frequency with the

Scanned Image of PC Board, Close-In Shot.

Total PCB area is approximately 50 mm².

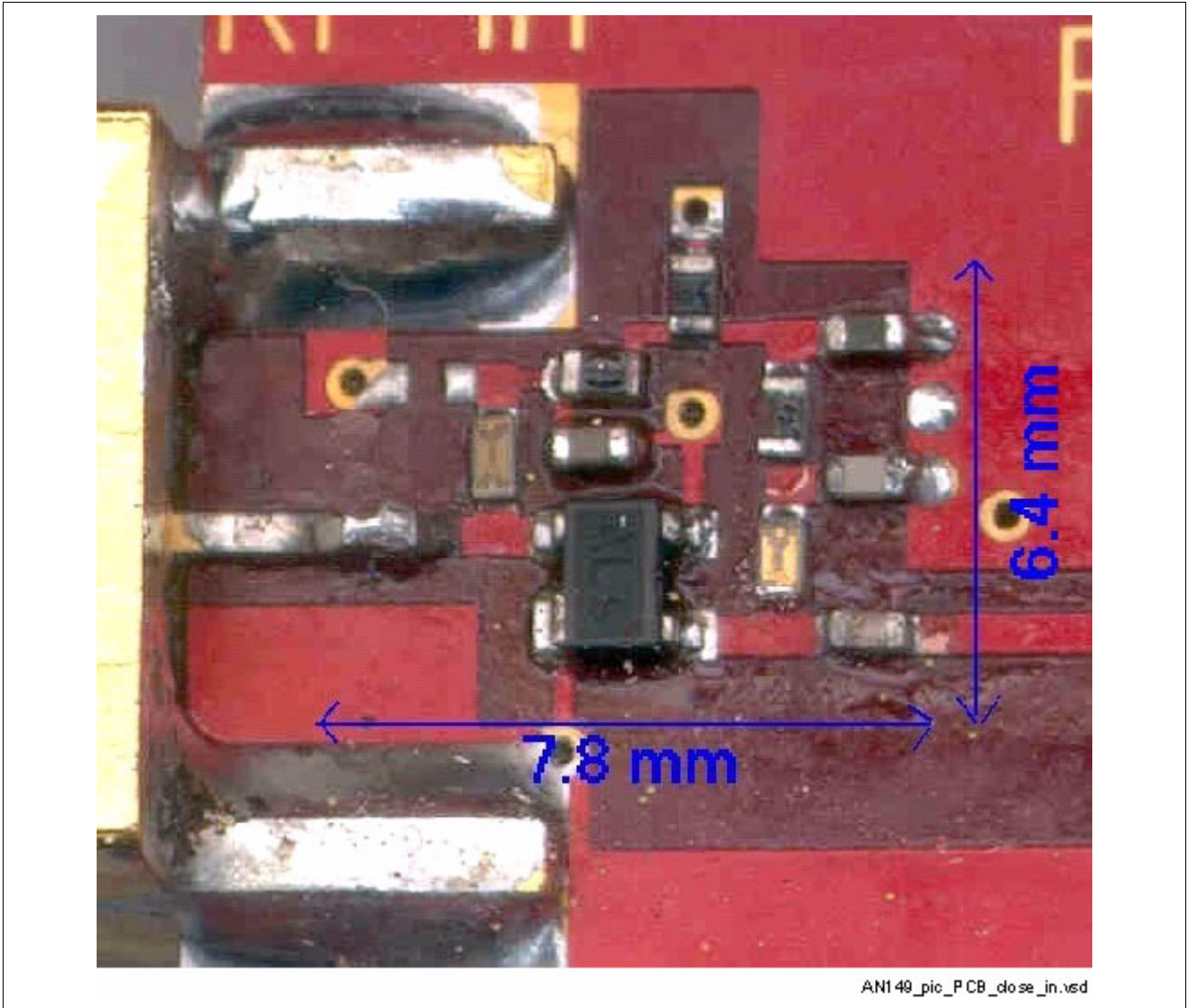

Figure 5 Image of PC Board, Close-In Shot

1.8 V, 2.6 mA Low Noise Amplifier for 1575 MHz GPS L1 Frequency with the

Amplifier Stability

$T = 25\text{ }^{\circ}\text{C}$, $V_{CC} = 1.8\text{ V}$, $V_{CE} = 1.5\text{ V}$, $I = 2.6\text{ mA}$.

Stability Factor "K" is shown below from "screen shot" taken from Rohde and Schwarz ZVC network analyzer. ZVC Vector Network Analyzer calculates and plots K in real time, from measured S parameters. Note that $K > 1$ from 5 MHz to 8 GHz; amplifier is unconditionally stable over this range.

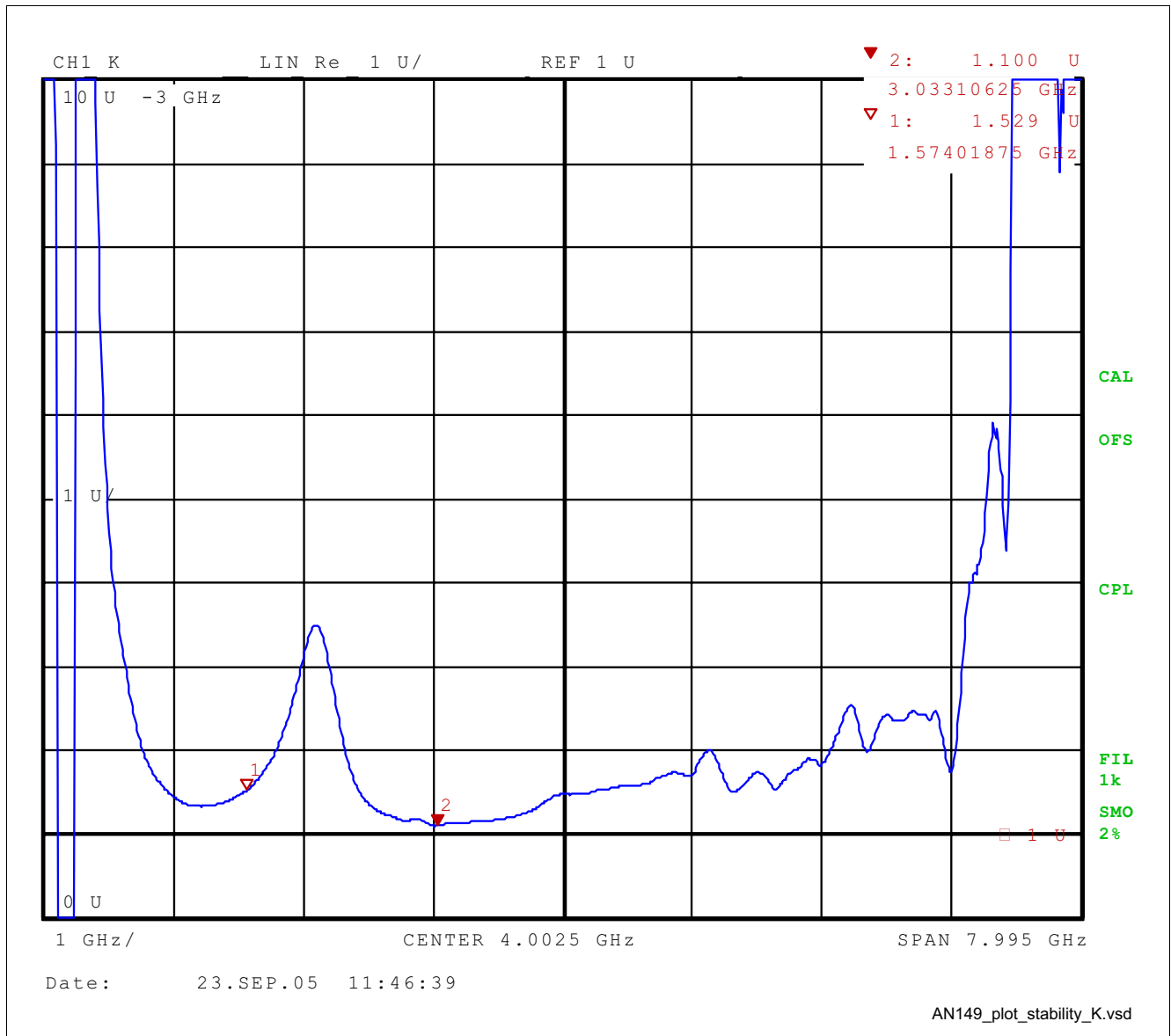

Figure 6 Plot of K(f)

1.8 V, 2.6 mA Low Noise Amplifier for 1575 MHz GPS L1 Frequency with the

Gain Compression at 1575 MHz, T = 25 °C

Amplifier is checked for 1 dB compression point. An Agilent power meter was used to ensure accurate power levels are measured (as opposed to using Vector Network Analyzer in "Power Sweep" mode).

Output $P_{1dB} \cong -8.7$ dBm; Input $P_{1dB} \cong -8.7$ dBm $-(\text{Gain} - 1 \text{ dB}) = -8.7$ dBm $- 14.3$ dB = -23.0 dBm

Table 4 Gain Compression at 1575 MHz

P_{OUT} , dBm	Gain, dB
-15.0	15.3
-14.0	15.3
-13.0	15.2
-12.0	15.1
-11.0	15.0
-10.0	14.8
-9.0	14.4
-8.0	14.0
-7.0	13.2

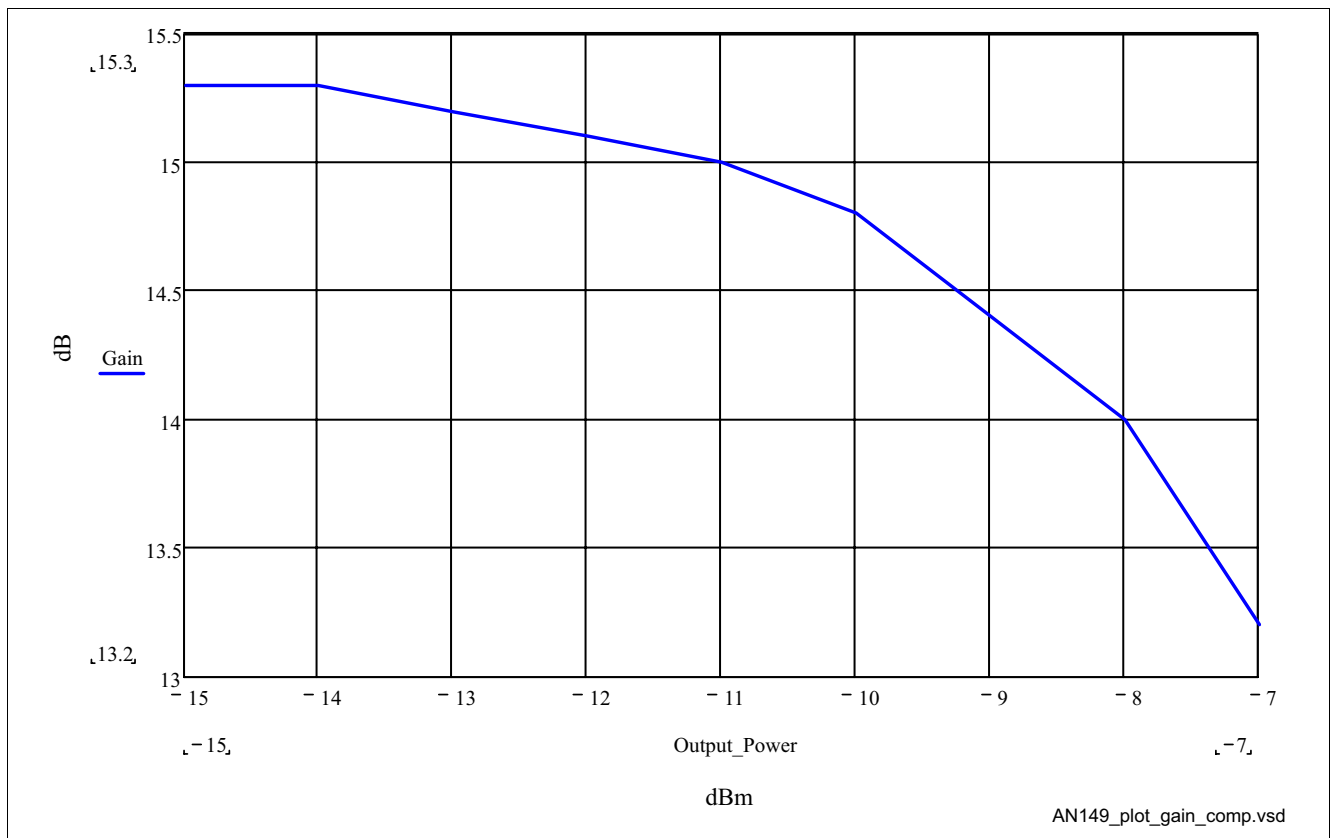

Figure 7 Plot of BFP405 Gain Compression, 1575.4 MHz

1.8 V, 2.6 mA Low Noise Amplifier for 1575 MHz GPS L1 Frequency with the

Please Note - all plots are taken from Rohde and Schwarz ZVC Network Analyzer
 T = 25 °C, source power ≈ -30 dBm.

Input Return Loss, Log Mag

5 MHz - 8 GHz Sweep

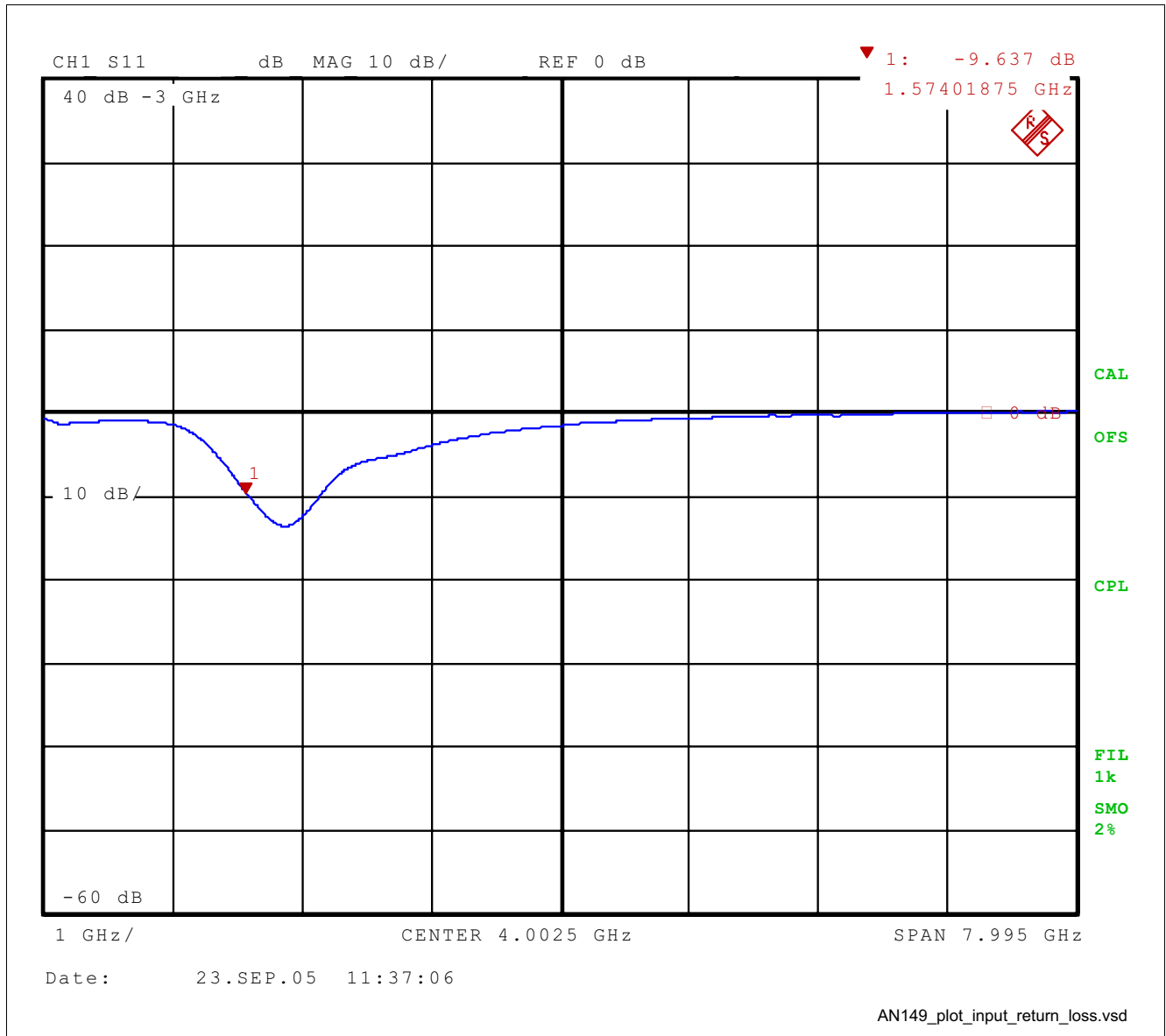

Figure 8 Plot of Input Return Loss

1.8 V, 2.6 mA Low Noise Amplifier for 1575 MHz GPS L1 Frequency with the

Input Return Loss, Smith Chart

Reference Plane = Input SMA Connector on PC Board
 5 MHz - 8 GHz Sweep

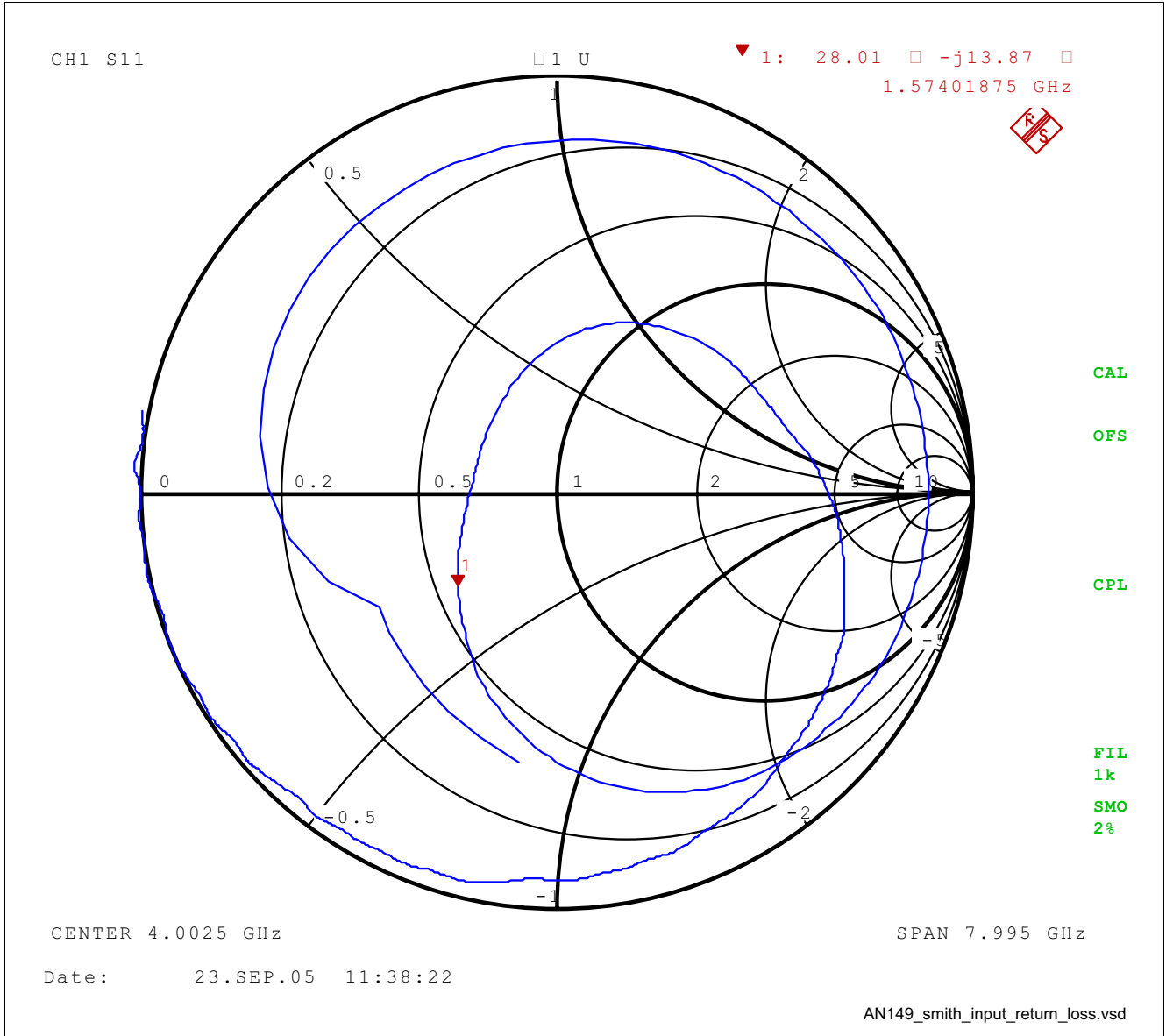

Figure 9 Smith Chart of Input Return Loss

1.8 V, 2.6 mA Low Noise Amplifier for 1575 MHz GPS L1 Frequency with the

Forward Gain
5 MHz - 8 GHz Sweep

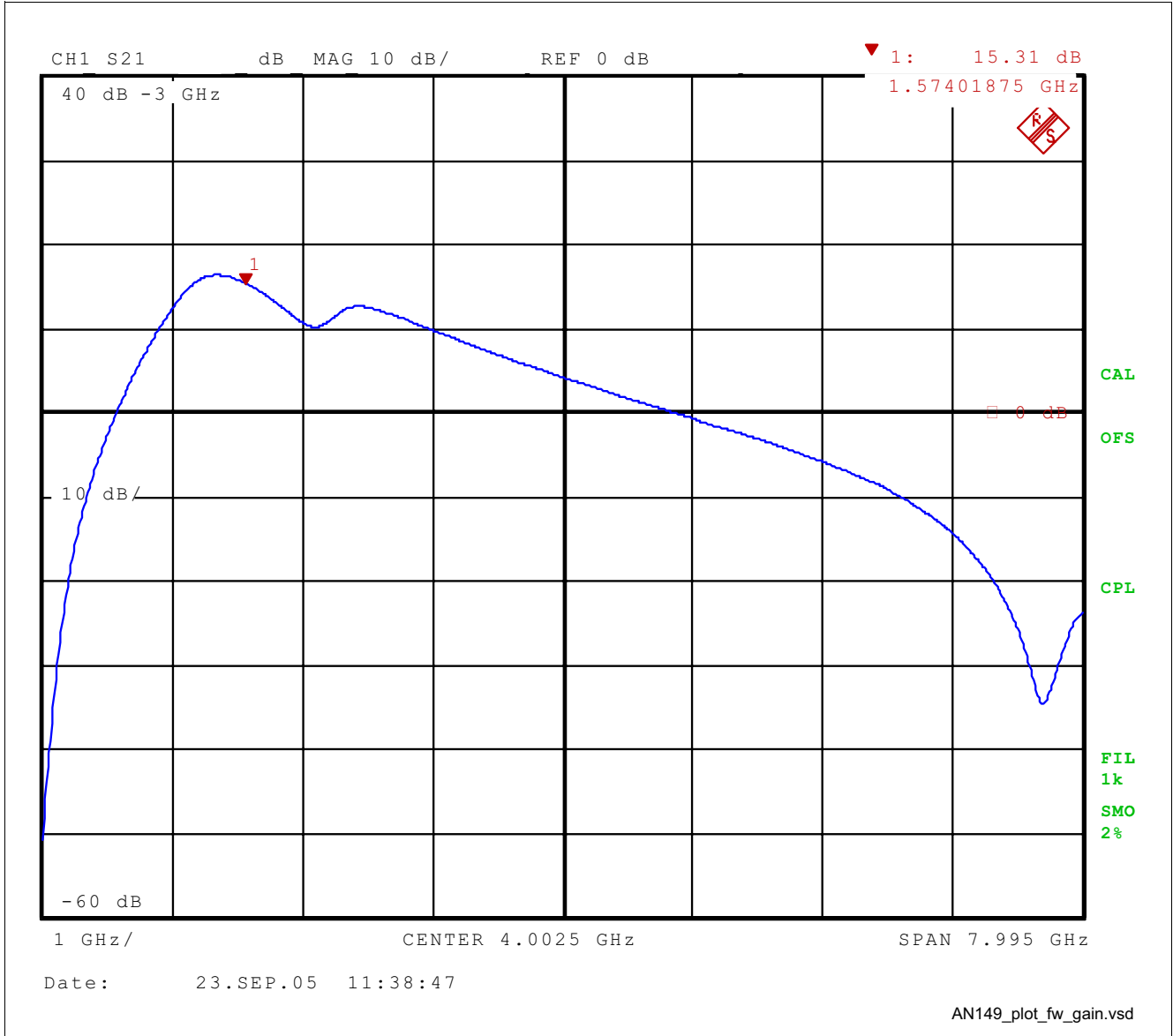

Figure 10 Plot of Forward Gain

1.8 V, 2.6 mA Low Noise Amplifier for 1575 MHz GPS L1 Frequency with the

Reverse Isolation

5 MHz - 8 GHz

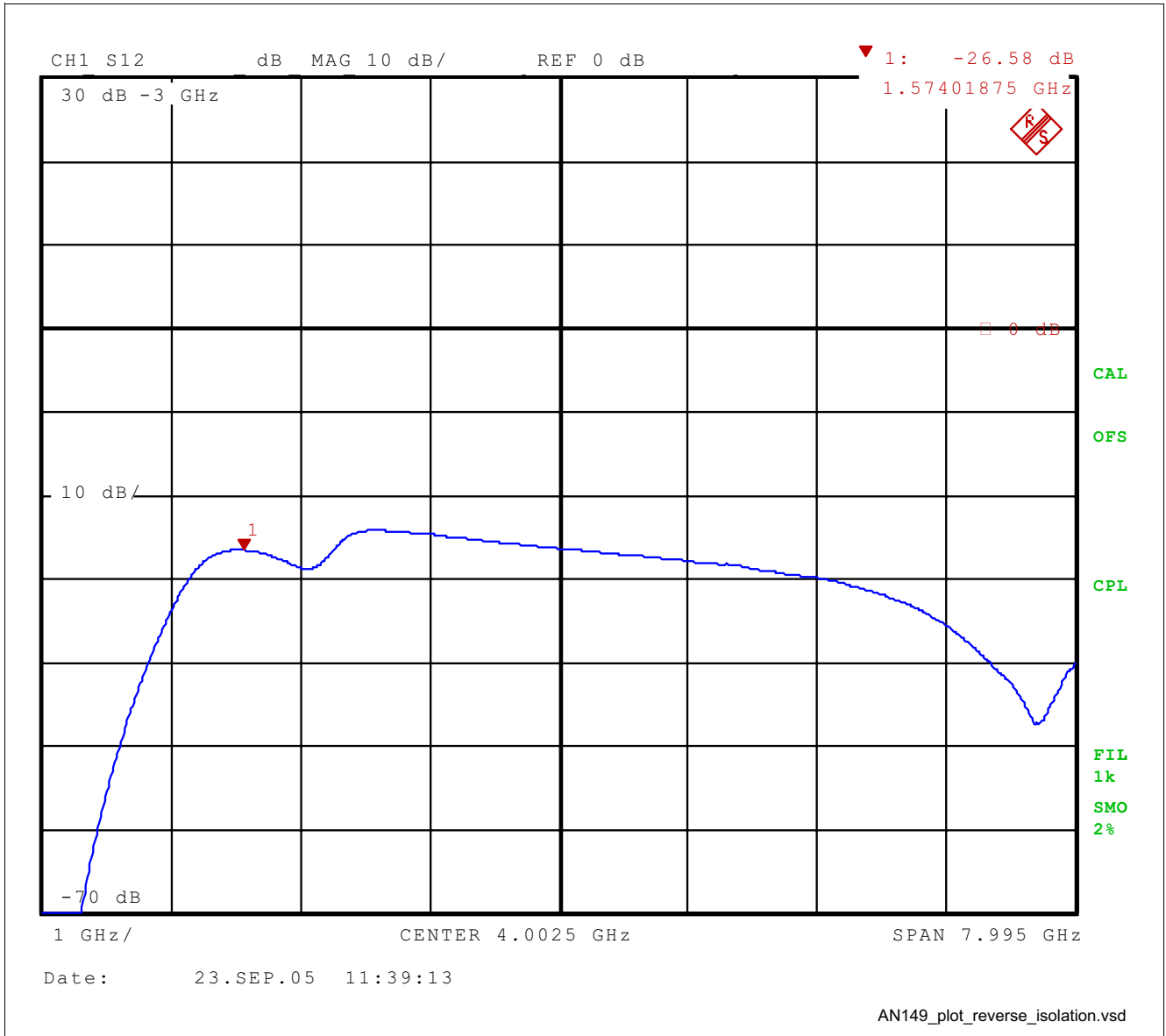

Figure 11 Plot of Reverse Isolation

1.8 V, 2.6 mA Low Noise Amplifier for 1575 MHz GPS L1 Frequency with the

Output Return Loss, Log Mag

5 MHz - 8 GHz

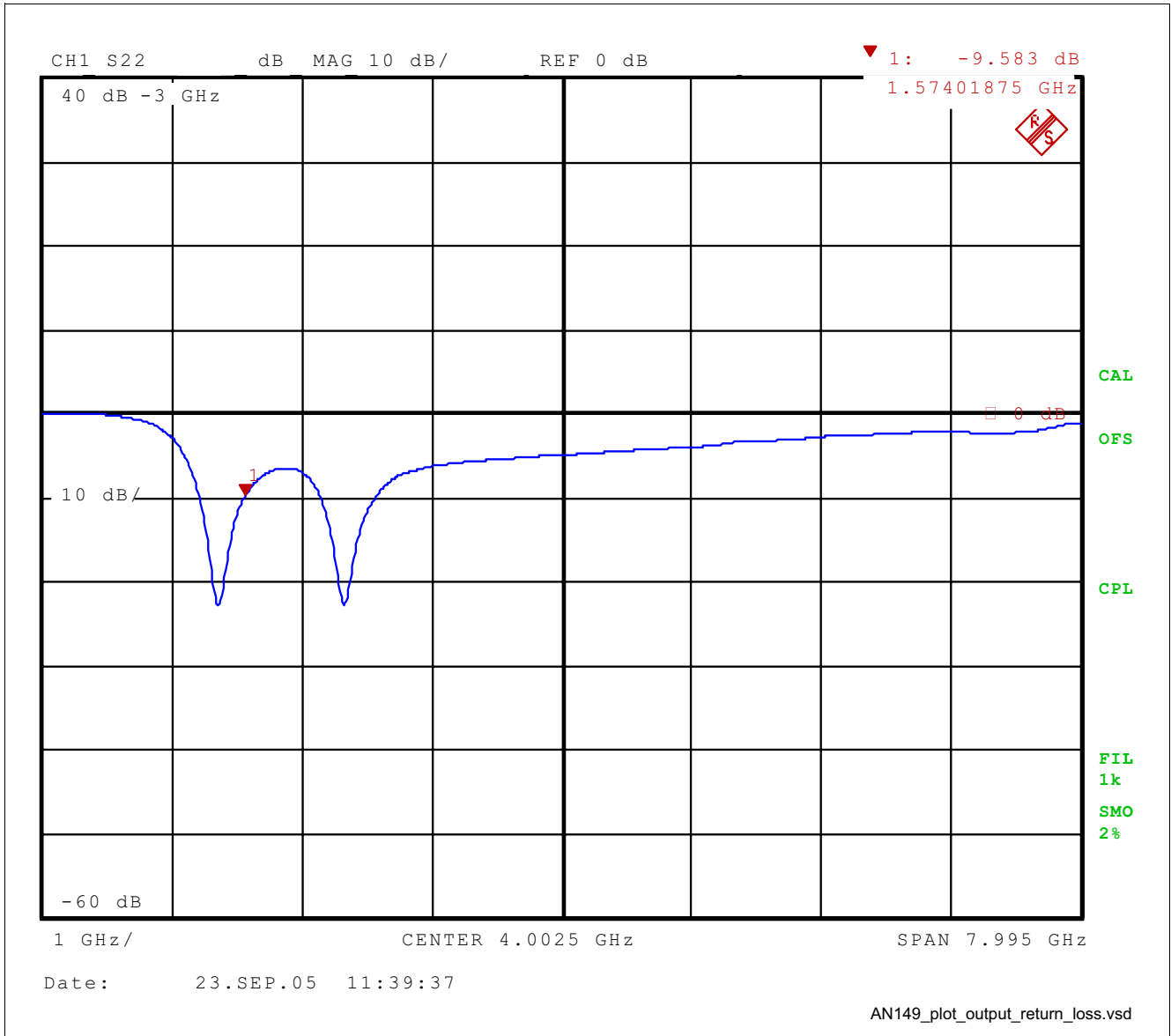

Figure 12 Plot of Output Return Loss

1.8 V, 2.6 mA Low Noise Amplifier for 1575 MHz GPS L1 Frequency with the

Output Return Loss, Smith Chart

Reference Plane = Output SMA Connector on PC Board
 5 MHz - 8 GHz Sweep

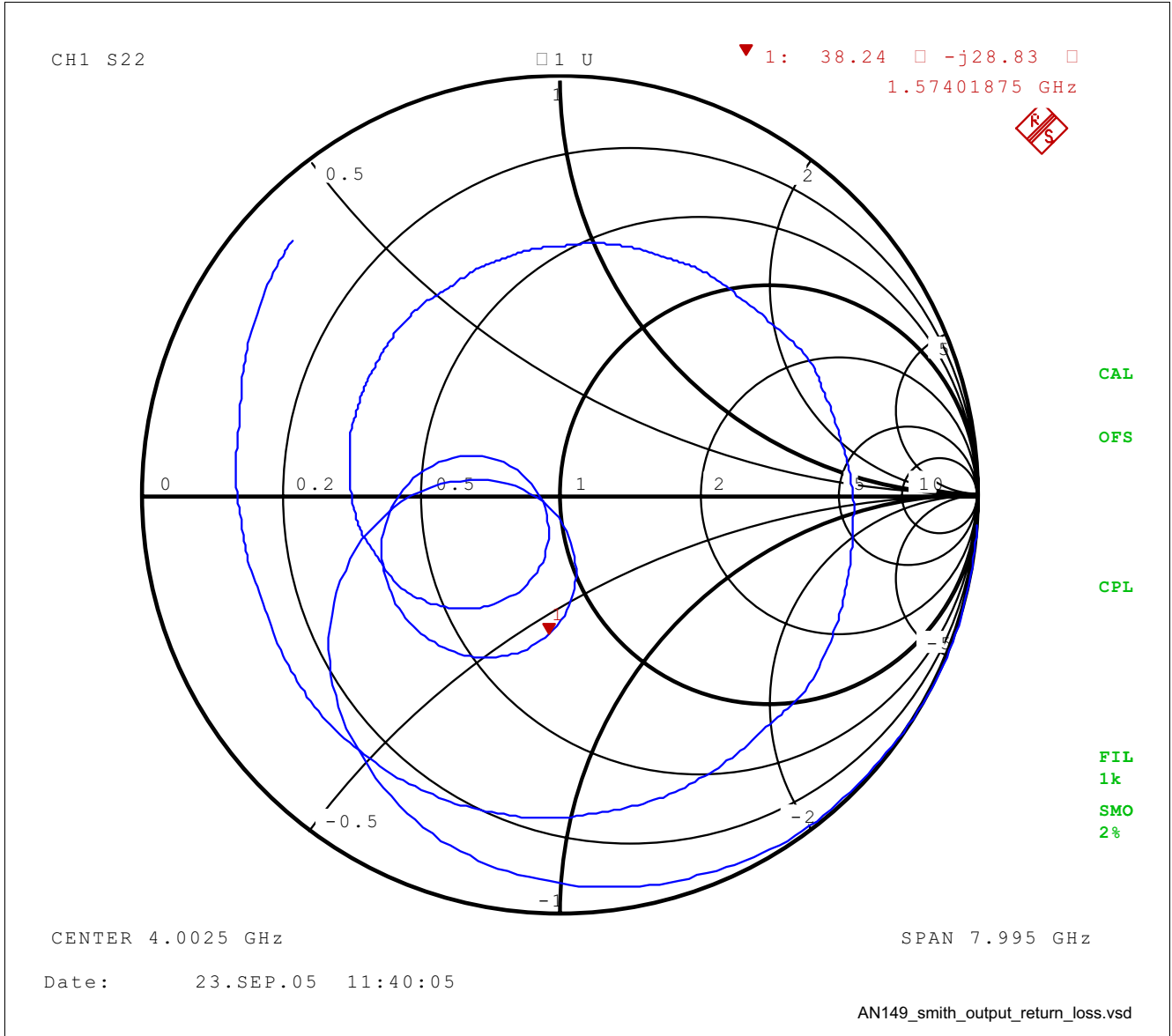

Figure 13 Smith Chart of Output Return Loss

1.8 V, 2.6 mA Low Noise Amplifier for 1575 MHz GPS L1 Frequency with the

Amplifier Response to Two Tone Test

Input stimulus: $f_1 = 1575 \text{ MHz}$, $f_2 = 1576 \text{ MHz}$, -30 dBm each tone.

Input $IP_3 = -30 + (50.0 / 2) = -5.0 \text{ dBm}$

Output $IP_3 = -5.0 \text{ dBm} + 15.3 \text{ dB gain} = +10.3 \text{ dBm}$

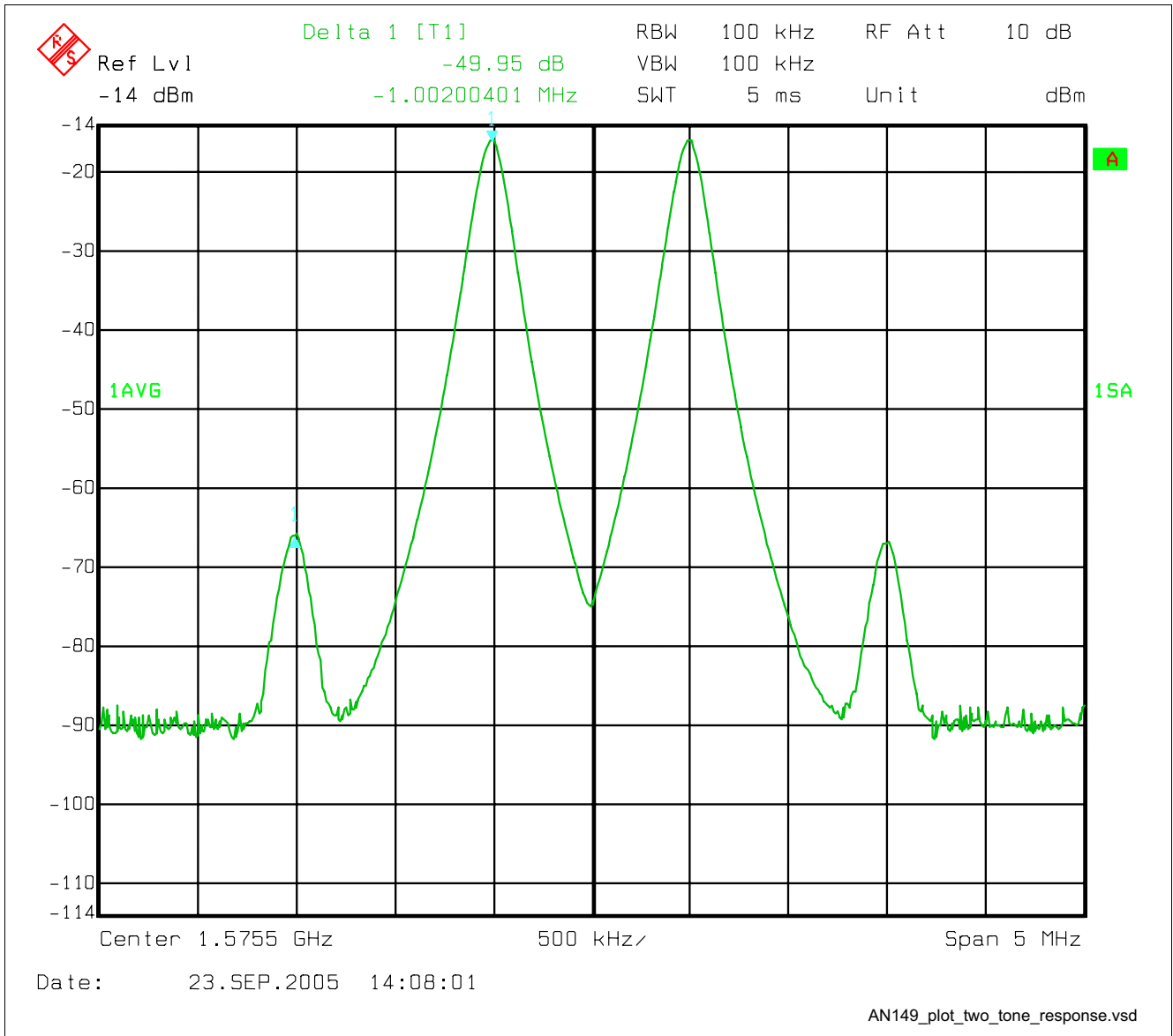

Figure 14 Tow-Tone Test, LNA Response