

MOSFET

英飞凌工业用 60 V OptiMOS™5 功率晶体管

特性

- 针对低压电机驱动应用进行了优化
- 针对电池供电应用进行了优化
- 实现自动光学焊料检测
- 100% 雪崩测试
- N沟道
- 额定温度为 175°C
- 无铅镀层；符合RoHS标准

产品验证

完全符合 JEDEC 工业应用标准

表 1 主要性能参数

Parameter	Value	Unit
V_{DS}	60	V
$R_{DS(on),max}$	1.5	mΩ
I_D	242	A
Q_{oss}	81	nC
$Q_G(0V...10V)$	71	nC

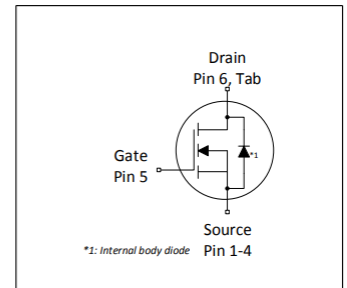
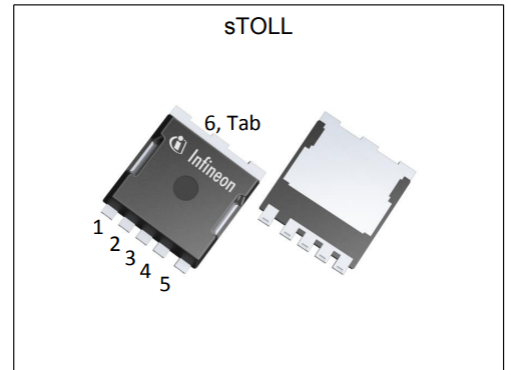

RoHS

Type / Ordering Code	Package	Marking	Related Links
IST015N06NM5	sTOLL	015N06N5	-

本数据手册的原文使用英文撰写。为方便起见，英飞凌提供了译文；由于翻译过程中可能使用了自动化工具，英飞凌不保证译文的准确性。为确认准确性，请务必访问 infineon.com 参考最新的英文版本（控制文档）。

目录

描述	1
最大额定值	3
热特性	3
电气特性	4
电气特性图	6
封装外形	10
修订记录	11
商标	11
免责声明	11

1 最大额定值

除非另有规定， $T_A = 25\text{ °C}$

表 2 最大额定值

Parameter	Symbol	Values			Unit	Note / Test Condition
		Min.	Typ.	Max.		
Continuous drain current ¹⁾	I_D	-	-	242 171 36	A	$V_{GS}=10\text{ V}, T_C=25\text{ °C}$ $V_{GS}=10\text{ V}, T_C=100\text{ °C}$ $V_{GS}=10\text{ V}, T_A=25\text{ °C}, R_{thJA}=40\text{ °C/W}^2)$
Pulsed drain current ³⁾	$I_{D,pulse}$	-	-	968	A	$T_C=25\text{ °C}$
Avalanche energy, single pulse ⁴⁾	E_{AS}	-	-	380	mJ	$I_D=50\text{ A}, R_{GS}=25\text{ }\Omega$
Gate source voltage	V_{GS}	-20	-	20	V	-
Power dissipation	P_{tot}	-	-	167 3.8	W	$T_C=25\text{ °C}$ $T_A=25\text{ °C}, R_{thJA}=40\text{ °C/W}^2)$
Operating and storage temperature	T_j, T_{stg}	-55	-	175	°C	-

2 热特性

表3 热特性

Parameter	Symbol	Values			Unit	Note / Test Condition
		Min.	Typ.	Max.		
Thermal resistance, junction - case	R_{thJC}	-	0.45	0.9	°C/W	-
Thermal resistance, junction - ambient, 6 cm ² cooling area ²⁾	R_{thJA}	-	-	40	°C/W	-

¹⁾额定值指产品仅具有数据表指定的绝对最大值，保持外壳温度符合规定要求。其他外壳温度请参见图 2。需要根据实际环境条件降低额定值。

²⁾器件安装在 40 mm x 40 mm x 1.5 mm 环氧树脂印刷电路板 FR4 上，漏极连接用铜面积为 6 cm²（一层，70 μm 厚）。印刷电路板垂直放置在静止空气中。

³⁾详细信息请参见图 3

⁴⁾详细信息请参见图 13

3 电气特性

除非另有规定， $T_j = 25\text{ °C}$

表4 静态特性

Parameter	Symbol	Values			Unit	Note / Test Condition
		Min.	Typ.	Max.		
Drain-source breakdown voltage	$V_{(BR)DSS}$	60	-	-	V	$V_{GS}=0\text{ V}, I_D=1\text{ mA}$
Gate threshold voltage	$V_{GS(th)}$	2.1	2.8	3.3	V	$V_{DS}=V_{GS}, I_D=95\text{ }\mu\text{A}$
Zero gate voltage drain current	I_{DSS}	-	0.5 10	1.0 100	μA	$V_{DS}=60\text{ V}, V_{GS}=0\text{ V}, T_j=25\text{ °C}$ $V_{DS}=60\text{ V}, V_{GS}=0\text{ V}, T_j=125\text{ °C}$
Gate-source leakage current	I_{GSS}	-	10	100	nA	$V_{GS}=20\text{ V}, V_{DS}=0\text{ V}$
Drain-source on-state resistance	$R_{DS(on)}$	-	1.3 1.9	1.5 2.4	$\text{m}\Omega$	$V_{GS}=10\text{ V}, I_D=50\text{ A}$ $V_{GS}=6\text{ V}, I_D=25\text{ A}$
Gate resistance	R_G	-	1.6	-	Ω	-
Transconductance ¹⁾	g_{fs}	70	140	-	S	$ V_{DS} \geq 2 I_D R_{DS(on)max}, I_D=50\text{ A}$

表5 动态特性

Parameter	Symbol	Values			Unit	Note / Test Condition
		Min.	Typ.	Max.		
Input capacitance	C_{iss}	-	5200	-	pF	$V_{DS}=0\text{ V}, V_{GS}=30\text{ V}, f=1\text{ MHz}$
Output capacitance	C_{oss}	-	1200	-	pF	$V_{GS}=0\text{ V}, V_{DS}=30\text{ V}, f=1\text{ MHz}$
Reverse transfer capacitance	C_{riss}	-	48	-	pF	$V_{GS}=0\text{ V}, V_{DS}=30\text{ V}, f=1\text{ MHz}$
Turn-on delay time	$t_{d(on)}$	-	22.48	-	ns	$V_{DD}=30\text{ V}, V_{GS}=10\text{ V}, I_D=50\text{ A},$ $R_{G,ext}=1.6\text{ }\Omega$
Rise time	t_r	-	63.6	-	ns	$V_{DD}=30\text{ V}, V_{GS}=10\text{ V}, I_D=50\text{ A},$ $R_{G,ext}=1.6\text{ }\Omega$
Turn-off delay time	$t_{d(off)}$	-	44.6	-	ns	$V_{DD}=30\text{ V}, V_{GS}=10\text{ V}, I_D=50\text{ A},$ $R_{G,ext}=1.6\text{ }\Omega$
Fall time	t_f	-	17.7	-	ns	$V_{DD}=30\text{ V}, V_{GS}=10\text{ V}, I_D=50\text{ A},$ $R_{G,ext}=1.6\text{ }\Omega$

表6 栅极电荷特性²⁾

Parameter	Symbol	Values			Unit	Note / Test Condition
		Min.	Typ.	Max.		
Gate to source charge	Q_{GS}	-	23	-	nC	$V_{DD}=30\text{ V}, I_D=50\text{ A}, V_{GS}=0\text{ to }10\text{ V}$
Gate charge at threshold	$Q_{G(th)}$	-	14.6	-	nC	$V_{DD}=30\text{ V}, I_D=50\text{ A}, V_{GS}=0\text{ to }10\text{ V}$
Gate to drain charge	Q_{gd}	-	12.9	-	nC	$V_{DD}=30\text{ V}, I_D=50\text{ A}, V_{GS}=0\text{ to }10\text{ V}$
Switching charge	Q_{sw}	-	21	-	nC	$V_{DD}=30\text{ V}, I_D=50\text{ A}, V_{GS}=0\text{ to }10\text{ V}$
Gate charge total ¹⁾	Q_g	-	71	89	nC	$V_{DD}=30\text{ V}, I_D=50\text{ A}, V_{GS}=0\text{ to }10\text{ V}$
Gate plateau voltage	$V_{plateau}$	-	4.3	-	V	$V_{DD}=30\text{ V}, I_D=50\text{ A}, V_{GS}=0\text{ to }10\text{ V}$
Gate charge total, sync. FET	$Q_{g(sync)}$	-	63	-	nC	$V_{DS}=0.1\text{ V}, V_{GS}=0\text{ to }10\text{ V}$
Output charge	Q_{oss}	-	81	-	nC	$V_{DS}=30\text{ V}, V_{GS}=0\text{ V}$

¹⁾由设计标定，不受制于生产测试。

²⁾参数定义请参见“栅极电荷波形”

表 7 反向二极管

Parameter	Symbol	Values			Unit	Note / Test Condition
		Min.	Typ.	Max.		
Diode continuous forward current	I_S	-	-	121	A	$T_C=25\text{ °C}$
Diode pulse current	$I_{S,pulse}$	-	-	968	A	$T_C=25\text{ °C}$
Diode forward voltage	V_{SD}	-	0.84	1.2	V	$V_{GS}=0\text{ V}, I_F=50\text{ A}, T_J=25\text{ °C}$
Reverse recovery time	t_{rr}	-	65.4	-	ns	$V_R=30\text{ V}, I_F=50\text{ A}, di_F/dt=100\text{ A}/\mu\text{s}$
Reverse recovery charge	Q_{rr}	-	101.1	-	nC	$V_R=30\text{ V}, I_F=50\text{ A}, di_F/dt=100\text{ A}/\mu\text{s}$

4 电气特性图

Diagram 1: Power dissipation

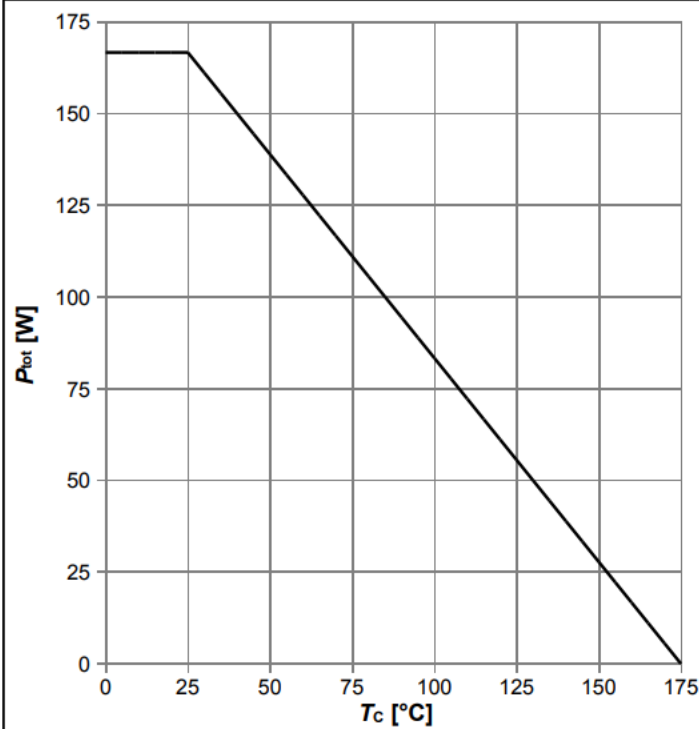

$P_{tot}=f(T_c)$

Diagram 2: Drain current

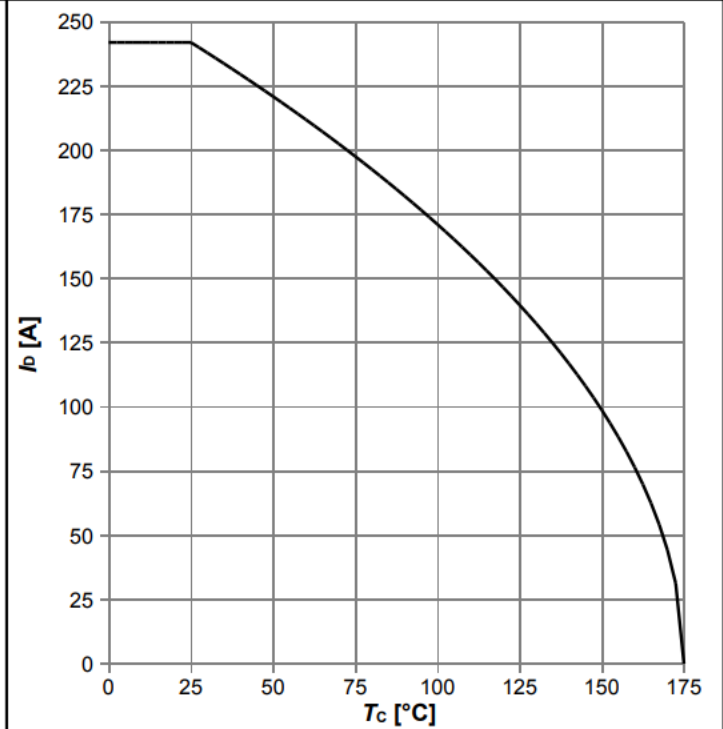

$I_D=f(T_c); V_{GS} \geq 10 \text{ V}$

Diagram 3: Safe operating area

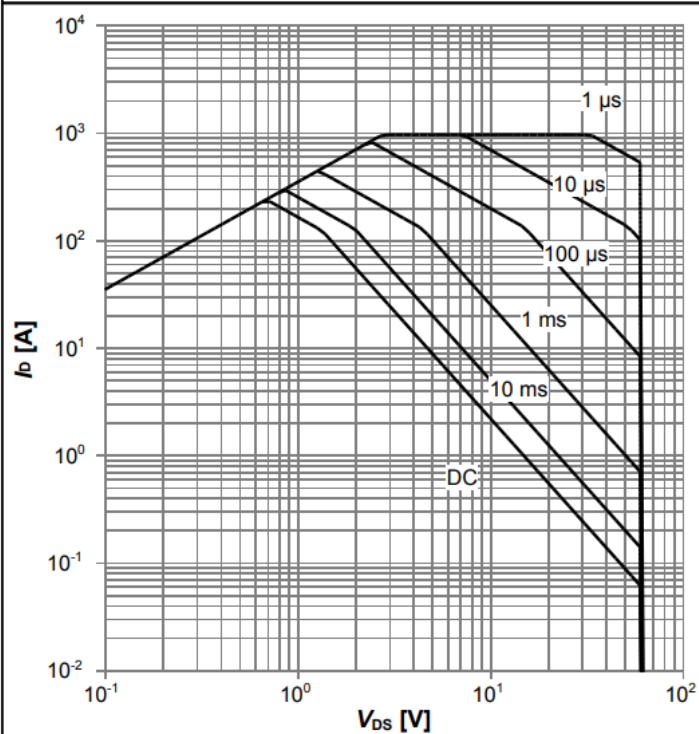

$I_D=f(V_{DS}); T_c=25 \text{ °C}; D=0; \text{parameter: } t_p$

Diagram 4: Max. transient thermal impedance

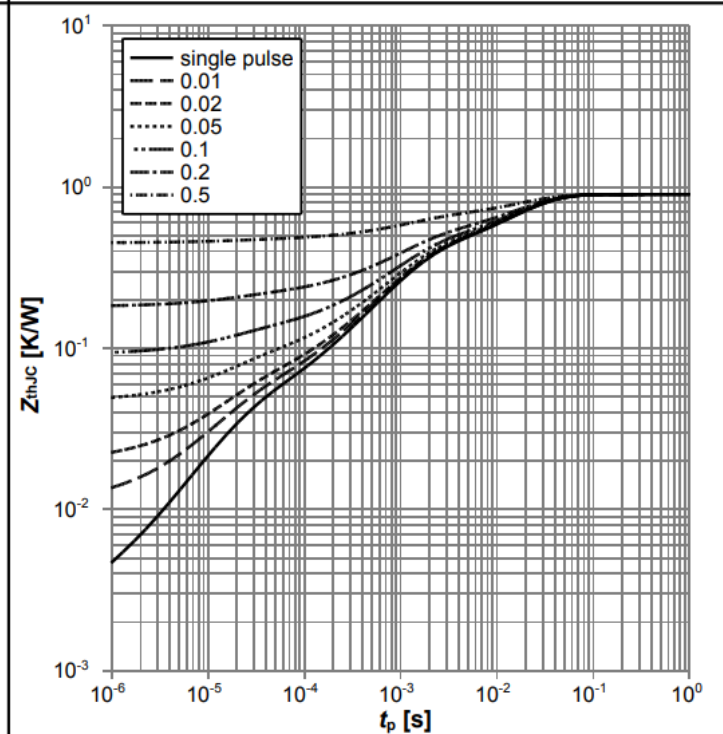

$Z_{thJC}=f(t_p); \text{parameter: } D=t_p/T$

OptiMOS™ 5 Power-Transistor, 60 V

IST015N06NM5

Diagram 5: Typ. output characteristics

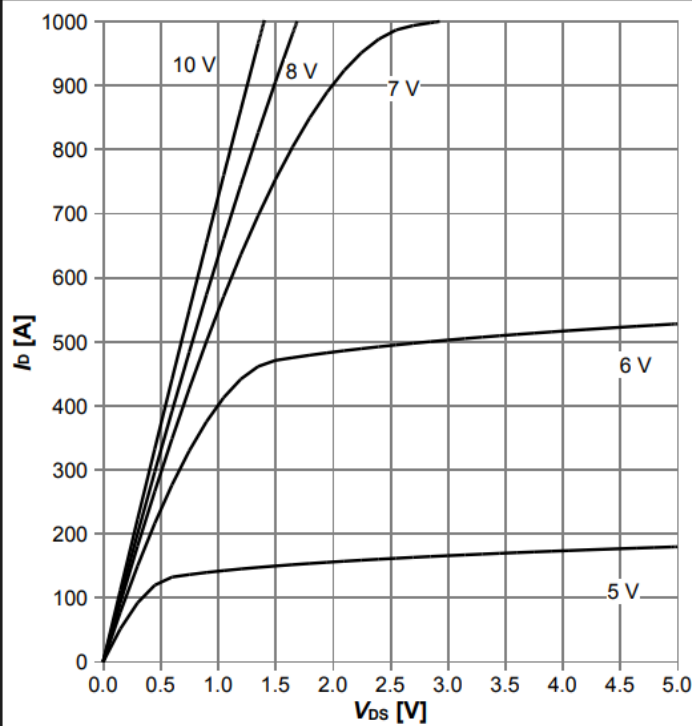

$I_D = f(V_{DS}), T_J = 25\text{ °C};$ parameter: V_{GS}

Diagram 6: Typ. drain-source on resistance

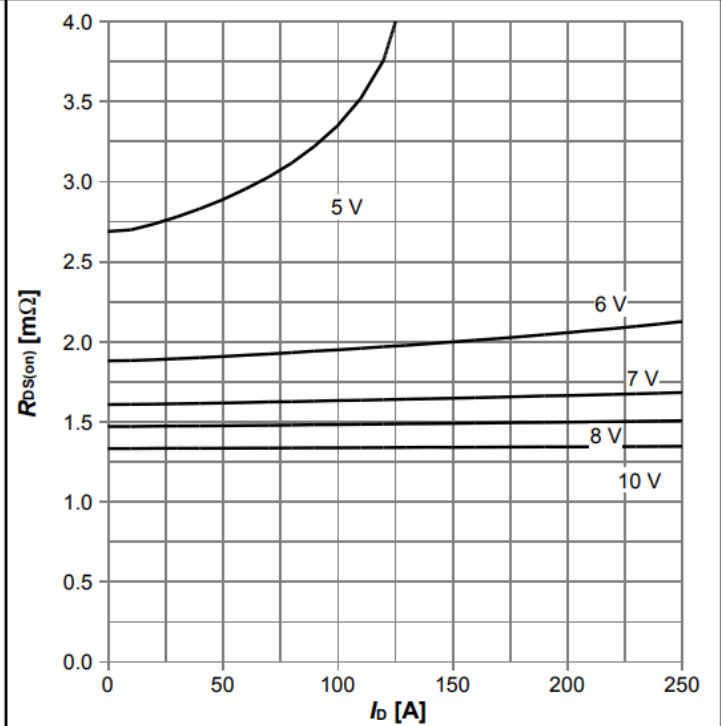

$R_{DS(on)} = f(I_D), T_J = 25\text{ °C};$ parameter: V_{GS}

Diagram 7: Typ. transfer characteristics

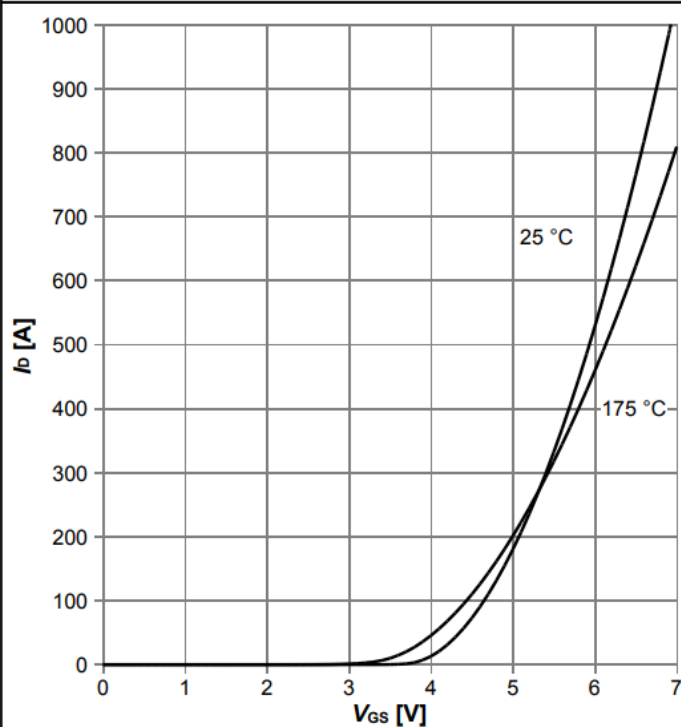

$I_D = f(V_{GS}), |V_{DS}| > 2|I_D|R_{DS(on)max};$ parameter: T_J

Diagram 8: Typ. drain-source on resistance

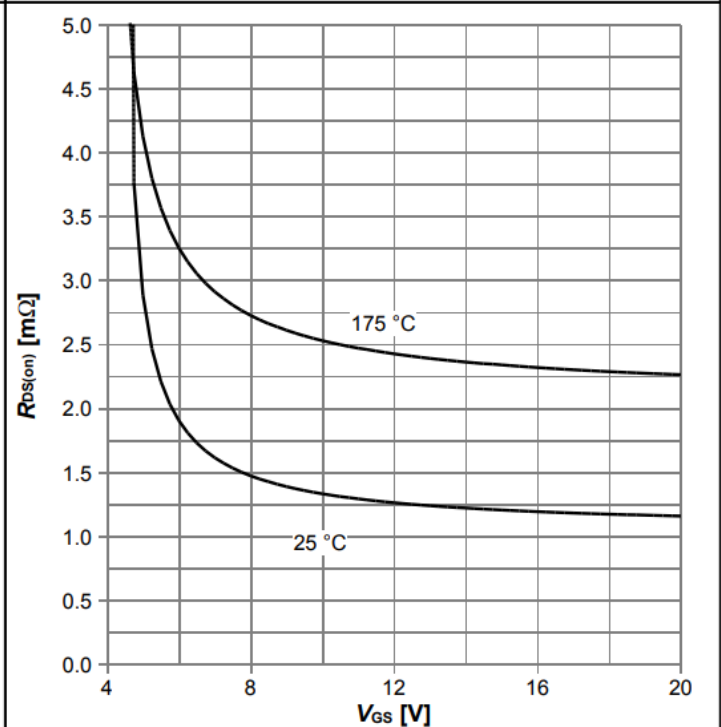

$R_{DS(on)} = f(V_{GS}), I_D = 50\text{ A};$ parameter: T_J

OptiMOS™ 5 Power-Transistor, 60 V

IST015N06NM5

Diagram 9: Normalized drain-source on resistance

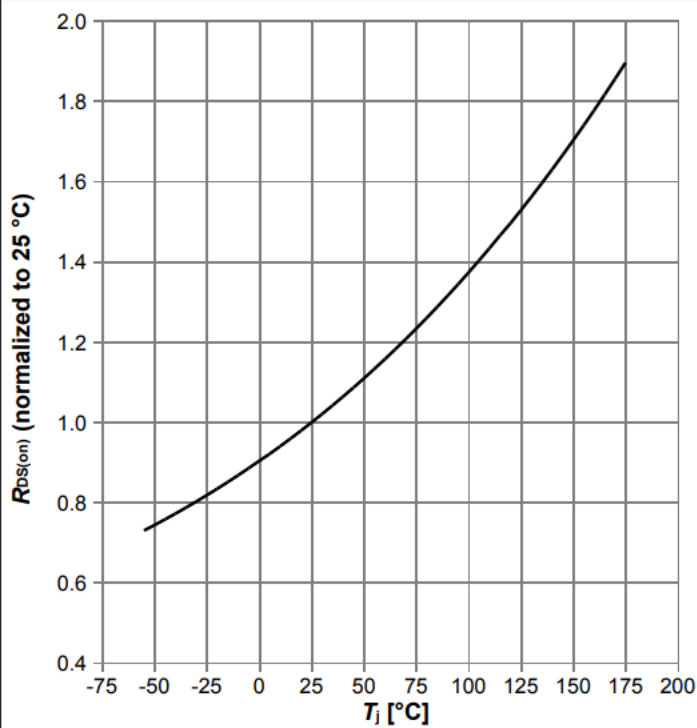

$R_{DS(on)}=f(T_j)$, $I_D=50$ A, $V_{GS}=10$ V

Diagram 10: Typ. gate threshold voltage

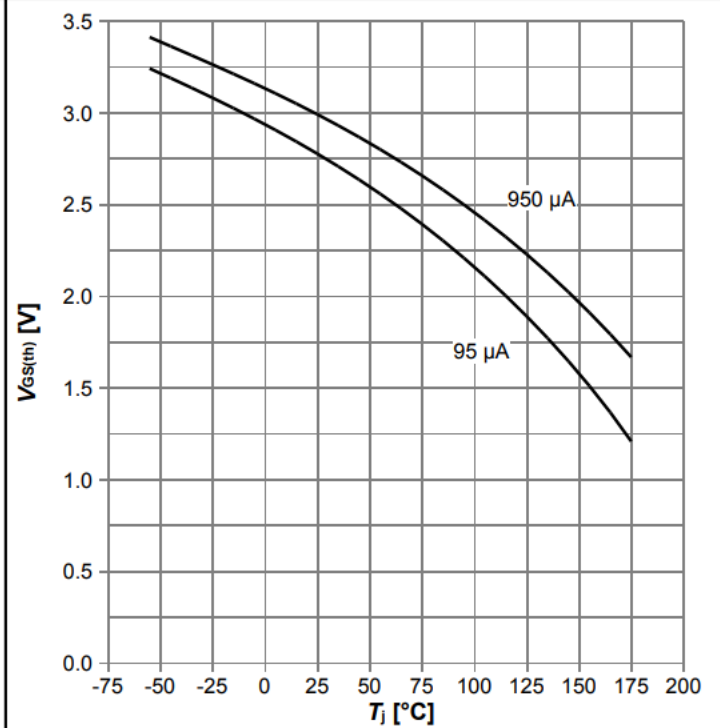

$V_{GS(th)}=f(T_j)$, $V_{GS}=V_{DS}$; parameter: I_D

Diagram 11: Typ. capacitances

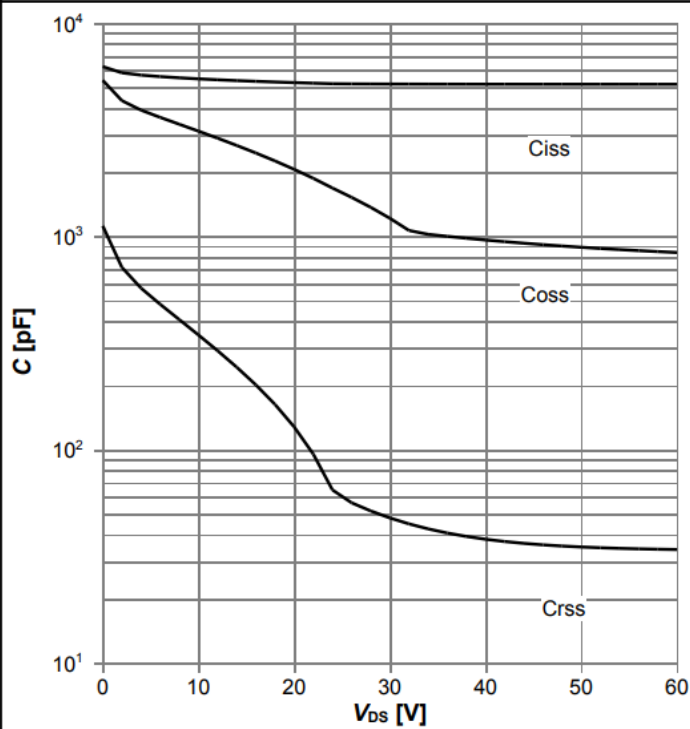

$C=f(V_{DS})$; $V_{GS}=0$ V; $f=1$ MHz

Diagram 12: Forward characteristics of reverse diode

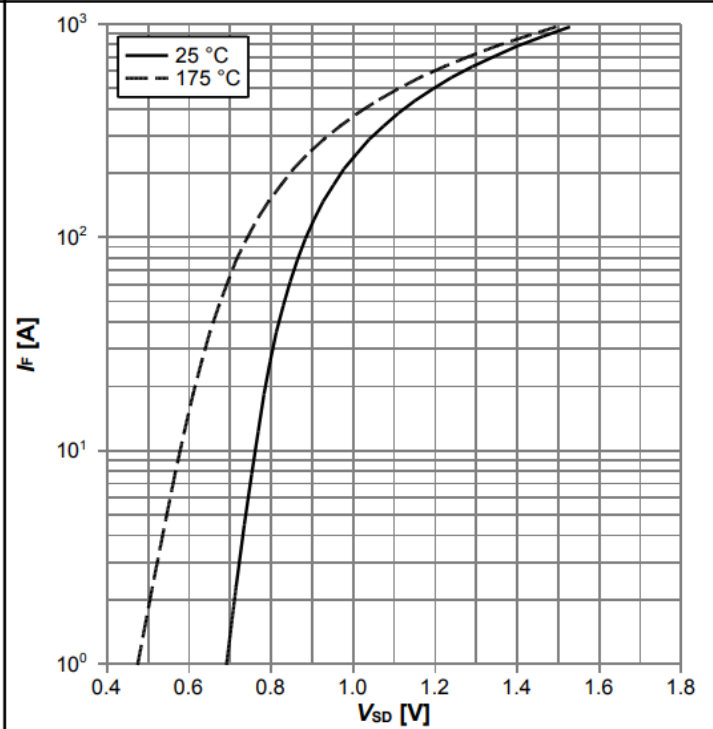

$I_F=f(V_{SD})$; parameter: T_j

OptiMOS™ 5 Power-Transistor, 60 V

IST015N06NM5

Diagram 13: Avalanche characteristics

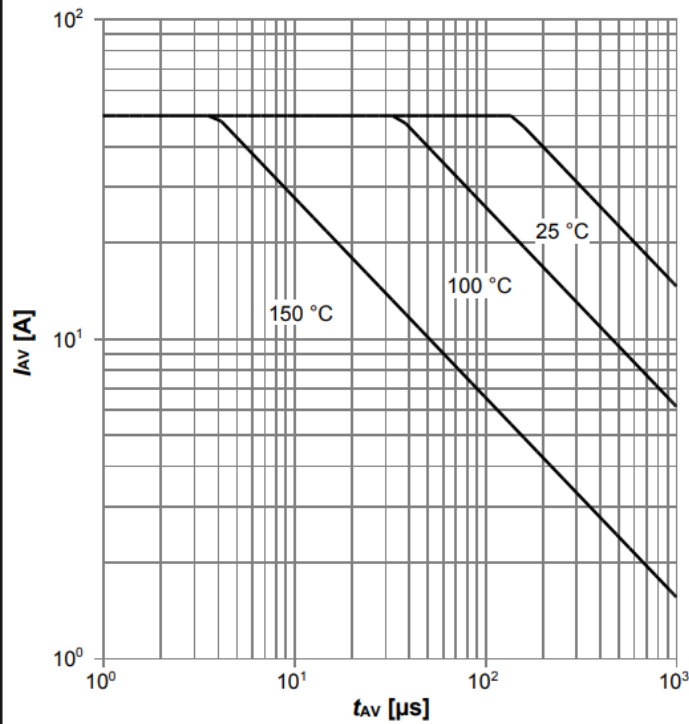

$I_{AS}=f(t_{AV}); R_{GS}=25 \Omega$; parameter: $T_{j,start}$

Diagram 14: Typ. gate charge

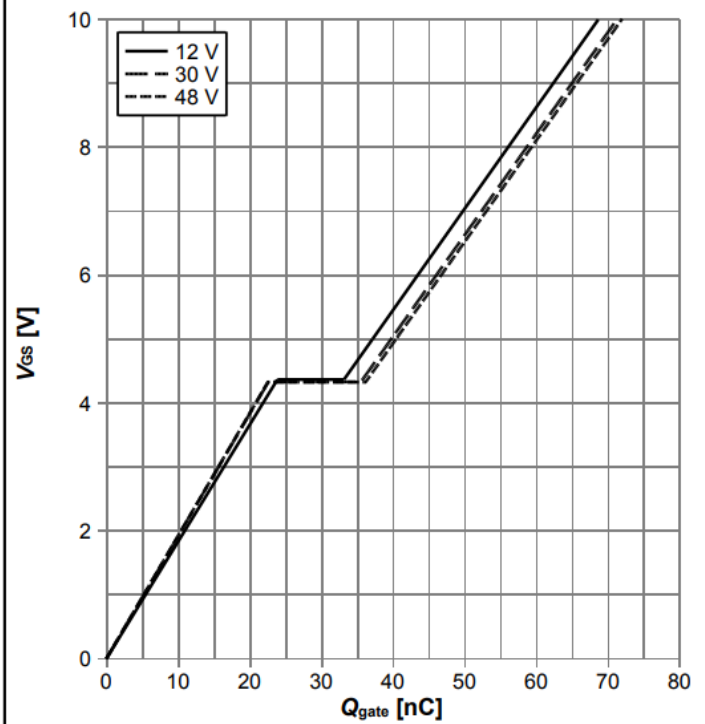

$V_{GS}=f(Q_{gate}), I_D=50$ A pulsed, $T_j=25$ °C; parameter: V_{DD}

Diagram 15: Drain-source breakdown voltage

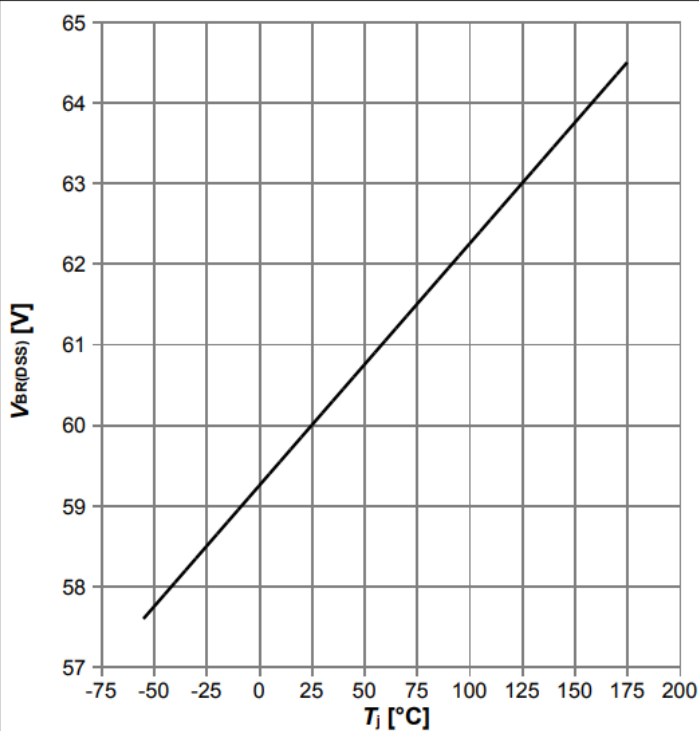

$V_{BR(DSS)}=f(T_j); I_D=1$ mA

Diagram Gate charge waveforms

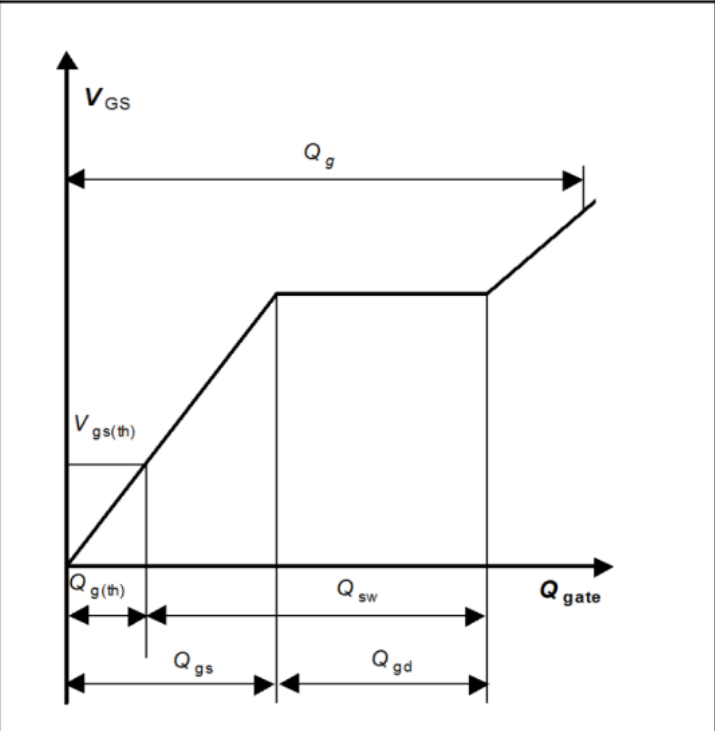

5 封装外形

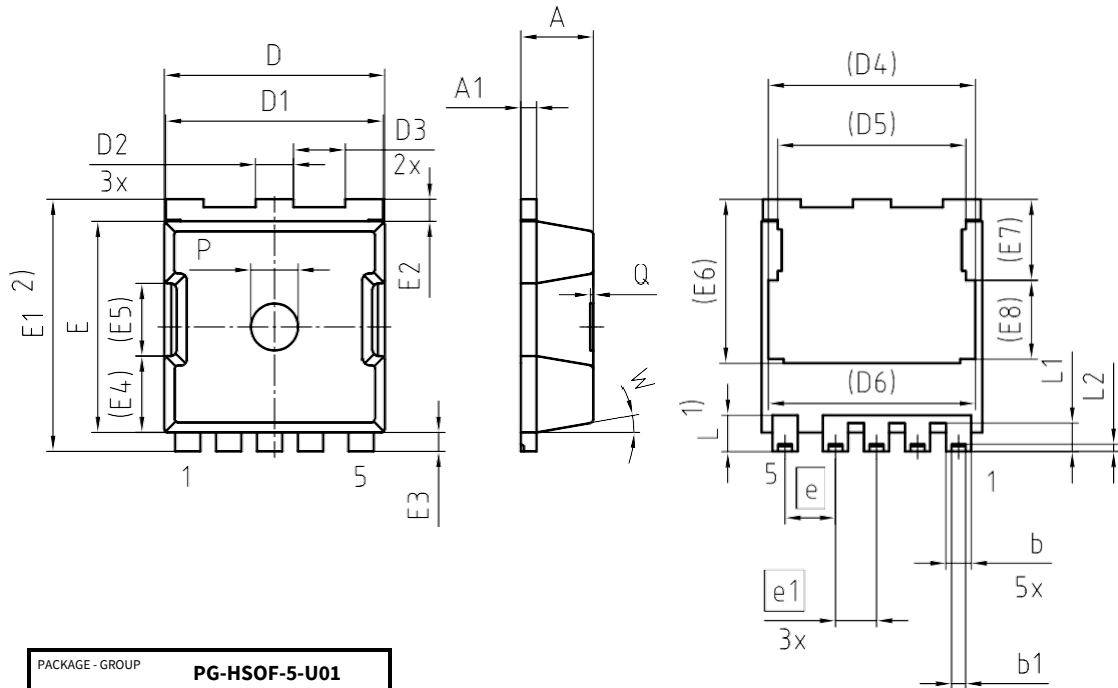

PACKAGE - GROUP		
PG-HSOF-5-U01		
NUMBER:		
REVISION: 02	DATE: 06.05.2021	
DIMENSIONS	MILLIMETERS	
	MIN.	MAX.
A	2.20	2.40
A1	0.40	0.60
b	0.70	0.90
b1	0.42	0.50
D	6.80	7.20
D1	6.80	7.00
D2	1.10	1.30
D3	1.55	1.75
D4	6.56	
D5	5.96	
D6	5.60	
E	6.50	6.90
E1	7.80	8.20
E2	0.60	0.80
E3	0.50	0.70
E4	2.43	
E5	2.30	
E6	5.20	
E7	2.57	
E8	2.50	
e	1.60	
e1	1.30	
L	1.05	1.25
L1	0.80	1.00
L2	0.13	0.33
P	1.40	1.60
Q	0.00	0.10
W	8.50°	11.50°

1) LEAD LENGTH UP TO ANTI FLASH PROFILE, MOLD FLASHES EXCLUDED.

2) EXCLUDING BURR

图 1 sTOLL 外形图，尺寸单位为毫米

修订记录

IST015N06NM5

Revision: 2022-04-28, Rev. 2.0

历史修订版本

Revision	Date	Subjects (major changes since last revision)
2.0	2022-04-28	Release of final version

Trademarks

All referenced product or service names and trademarks are the property of their respective owners.

We Listen to Your Comments

Any information within this document that you feel is wrong, unclear or missing at all? Your feedback will help us to continuously improve the quality of this document. Please send your proposal (including a reference to this document) to:

erratum@infineon.com

Published by

Infineon Technologies AG 81726

München, Germany

© 2022 Infineon Technologies AG All

Rights Reserved.

Legal Disclaimer

The information given in this document shall in no event be regarded as a guarantee of conditions or characteristics (“Beschaffenheitsgarantie”).

With respect to any examples, hints or any typical values stated herein and/or any information regarding the application of the product, Infineon Technologies hereby disclaims any and all warranties and liabilities of any kind, including without limitation warranties of non-infringement of intellectual property rights of any third party.

In addition, any information given in this document is subject to customer’s compliance with its obligations stated in this document and any applicable legal requirements, norms and standards concerning customer’s products and any use of the product of Infineon Technologies in customer’s applications.

The data contained in this document is exclusively intended for technically trained staff. It is the responsibility of customer’s technical departments to evaluate the suitability of the product for the intended application and the completeness of the product information given in this document with respect to such application.

Information

For further information on technology, delivery terms and conditions and prices please contact your nearest Infineon Technologies Office (www.infineon.com).

Warnings

Due to technical requirements, components may contain dangerous substances. For information on the types in question, please contact the nearest Infineon Technologies Office.

The Infineon Technologies component described in this Data Sheet may be used in life-support devices or systems and/or automotive, aviation and aerospace applications or systems only with the express written approval of Infineon Technologies, if a failure of such components can reasonably be expected to cause the failure of that life-support, automotive, aviation and aerospace device or system or to affect the safety or effectiveness of that device or system. Life support devices or systems are intended to be implanted in the human body or to support and/or maintain and sustain and/or protect human life. If they fail, it is reasonable to assume that the health of the user or other persons may be endangered.



免责声明

请注意，本文件的原文使用英文撰写，为方便客户浏览英飞凌提供了中文译文。该中文译文仅供参考，并不可作为任何论点之依据。

由于翻译过程中可能使用了自动化程序，以及语言翻译和转换过程中的差异，最后的中文译文与最新的英文版本原文含义可能存在不尽相同之处。

因此，我们同时提供该中文译文版本的最新英文原文供您阅读，请参见 <http://www.infineon.com>

英文原文和中文译文版本之间若存有任何歧异，以最新的英文版本为准，并且仅认可英文版本为正式文件。

您如果使用本文件，即表示您同意并理解上述说明。英飞凌不对因翻译过程中可能存在的任何不完整或不准确信息而产生的任何直接或间接损失或损害负责。英飞凌不承担中文译文版本的完整性和准确性责任。如果您不同意上述说明，请不要使用本文件。

Trademarks

All referenced product or service names and trademarks are the property of their respective owners.

重要通知

版本 2025-09-29

Infineon Technologies AG 出版，
德国 Neubiberg 85579

版权 © 2025 Infineon Technologies AG
及其关联公司。
保留所有权利。

**Do you have a question about this
document?**

Email:
erratum@infineon.com

Infineon Technologies AG 及其关联公司（以下简称“英飞凌”）销售或提供和交付的产品（可能也包括样品，且可能由硬件或软件或两者组成）（以下简称“产品”），应遵守客户与英飞凌签订的框架供应合同或其他书面协议的条款和条件，如无上合同或其他书面协议，则应遵守适用的英飞凌销售条件。只有在英飞凌明确书面同意的情况下，客户的一般条款和条件或对适用的英飞凌销售条件的偏离才对英飞凌具有约束力。

为避免疑义，英飞凌不承担侵犯第三方权利的所有保证和默示保证，例如对特定用途/目的的适用性或适销性的保证。

英飞凌对与样品、应用或客户对任何产品的具体使用有关的任何信息或本文中给出的任何示例或典型值概不负责。

本文件中包含的数据仅供具有技术资格和技能的客户代表使用。客户有责任评估产品对预期应用和客户特定用途的适用性，并在预期应用和客户特定用途中验证本文件中包含的所有相关技术数据。客户有责任正确设计、编程和测试预期应用的功能性和安全性，并遵守与其使用相关的法律要求。

除非英飞凌另行明确批准，否则产品不得用于任何因产品故障或使用产品的任何后果可合理预期会导致人身伤害的应用。但是，上述规定并不妨碍客户在英飞凌明确设计和销售的使用领域中使用任何产品，但是客户对应用负有全部责任。

英飞凌明确保留根据适用法律，如《德国版权法》（UrhG）第 44b 条，将其内容用于商业资料和数据探勘（TDM）的权利。

如果产品包含安全功能：

由于任何计算设备都不可能绝对安全，尽管产品采取了安全措施，但英飞凌不保证产品不会被入侵、数据不会被盗或遗失，或不会发生其他漏洞（以下简称“安全漏洞”），英飞凌对任何安全漏洞不承担任何责任。

如果本文档包含或引用软件：

根据美国、德国和世界其他国家的知识产权法律和条约，该软件归英飞凌所有。英飞凌保留所有权利。因此，您只能按照软件附带的软件授权协议的规定使用本软件。

如果没有适用的软件授权协议，英飞凌特此授予您个人的、非排他性的、不可转让的软件知识产权授权（无权转授权）：(a) 对于以源代码形式提供的软件，仅在贵组织内部修改和复制该软件用于英飞凌硬件产品；及 (b) 对于以二进制代码 (binary code) 形式对外向终端用户分发该软件，仅得用于英飞凌硬件产品。禁止对本软件进行任何其他使用、复制、修改、翻译或编译。有关产品、技术、交货条款和条件以及价格的详细信息，请联系离您最近的英飞凌办公室或访问 <https://www.infineon.com>。