

MOSFET

OptiMOS™ 7 Power-Transistor, 40 V

Features

- N-channel, logic level
- Very low on-resistance $R_{DS(on)}$
- Superior thermal resistance
- 100% avalanche tested
- Pb-free lead plating; RoHS compliant
- Halogen-free according to IEC61249-2-21

Product validation

Qualified according to relevant JEDEC tests.

Table 1 Key performance parameters

Parameter	Value	Unit
V_{DS}	40	V
$R_{DS(on),max}$	1.0	mΩ
I_D	270	A
Q_{oss}	43	nC
$Q_G (0V...4.5V)$	18.9	nC

PG-WHTFN-9 (3x3)

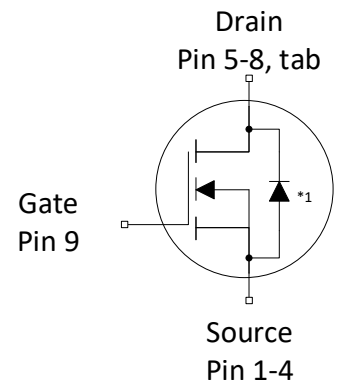
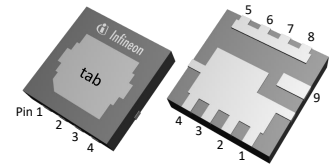

*1: Internal body diode

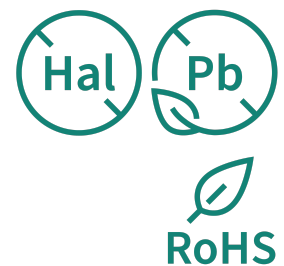

Part number	Package	Marking	Related links
IQE010N04LM7CGSC	PG-WHTFN-9	A	-



Table of contents

Description	1
Maximum ratings	3
Thermal characteristics	3
Electrical characteristics	4
Electrical characteristics diagrams	6
Package outlines	10
Revision history	13
Trademarks	14
Disclaimer	14

1 Maximum ratings

at $T_A=25\text{ °C}$, unless otherwise specified

Table 2 Maximum ratings

Parameter	Symbol	Values			Unit	Note / Test condition
		Min.	Typ.	Max.		
Continuous drain current ¹⁾	I_D	-	-	270	A	$V_{GS}=10\text{ V}, T_C=25\text{ °C}$
				191		$V_{GS}=10\text{ V}, T_C=100\text{ °C}$
				168		$V_{GS}=4.5\text{ V}, T_C=100\text{ °C}$
				35		$V_{GS}=10\text{ V}, T_A=25\text{ °C}, R_{thJA}=60\text{ °C/W}^2)$
Pulsed drain current ³⁾	$I_{D,pulse}$	-	-	1080	A	$T_A=25\text{ °C}$
Avalanche energy, single pulse ⁴⁾	E_{AS}	-	-	255	mJ	$I_D=20\text{ A}, R_{GS}=25\text{ }\Omega$
Gate source voltage	V_{GS}	-12	-	12	V	-
Power dissipation	P_{tot}	-	-	150	W	$T_C=25\text{ °C}$
				2.5		$T_A=25\text{ °C}, R_{thJA}=60\text{ °C/W}^2)$
Operating and storage temperature	T_j, T_{stg}	-55	-	175	°C	-

¹⁾ Rating refers to the product only with datasheet specified absolute maximum values, maintaining case temperature as specified. For other case temperatures please refer to Diagram 2. De-rating will be required based on the actual environmental conditions.

²⁾ Device on 40 mm x 40 mm x 1.5 mm epoxy PCB FR4 with 6 cm² (one layer, 70 µm thick) copper area for drain connection. PCB is vertical in still air.

³⁾ See Diagram 3 for more detailed information

⁴⁾ See Diagram 13 for more detailed information

2 Thermal characteristics

Table 3 Thermal characteristics

Parameter	Symbol	Values			Unit	Note / Test condition
		Min.	Typ.	Max.		
Thermal resistance, junction - case, bottom	R_{thJC}	-	-	1.0	°C/W	-
Thermal resistance, junction - case, top	R_{thJC}			1.4		
Thermal resistance, junction - ambient, 6 cm ² cooling area ⁵⁾	R_{thJA}			60		

⁵⁾ Device on 40 mm x 40 mm x 1.5 mm epoxy PCB FR4 with 6 cm² (one layer, 70 µm thick) copper area for drain connection. PCB is vertical in still air.

3 Electrical characteristics

at $T_j=25\text{ °C}$, unless otherwise specified

Table 4 Static characteristics

Parameter	Symbol	Values			Unit	Note / Test condition
		Min.	Typ.	Max.		
Drain-source breakdown voltage	$V_{(BR)DSS}$	40	-	-	V	$V_{GS}=0\text{ V}$, $I_D=1\text{ mA}$
Gate threshold voltage	$V_{GS(th)}$	1.1	1.4	1.7	V	$V_{DS}=V_{GS}$, $I_D=458\text{ }\mu\text{A}$
Zero gate voltage drain current	I_{DSS}	-	0.1	1	μA	$V_{DS}=32\text{ V}$, $V_{GS}=0\text{ V}$, $T_j=25\text{ °C}$
			10	100		$V_{DS}=32\text{ V}$, $V_{GS}=0\text{ V}$, $T_j=125\text{ °C}$
Gate-source leakage current	I_{GSS}	-	10	100	nA	$V_{GS}=12\text{ V}$, $V_{DS}=0\text{ V}$
Drain-source on-state resistance	$R_{DS(on)}$	-	0.85	1.0	m Ω	$V_{GS}=10\text{ V}$, $I_D=20\text{ A}$
			0.93	1.1		$V_{GS}=6\text{ V}$, $I_D=20\text{ A}$
			1.04	1.3		$V_{GS}=4.5\text{ V}$, $I_D=20\text{ A}$
Gate resistance ⁶⁾	R_G	-	0.8	-	Ω	-
Transconductance ⁶⁾	g_{fs}	66	130	-	S	$ V_{DS} \geq 2 I_D $, $R_{DS(on)max}$, $I_D=20\text{ A}$

⁶⁾ Defined by design. Not subject to production test.

Table 5 Dynamic characteristics

Parameter	Symbol	Values			Unit	Note / Test condition
		Min.	Typ.	Max.		
Input capacitance ⁷⁾	C_{iss}	-	3000	3900	pF	$V_{GS}=0\text{ V}$, $V_{DS}=20\text{ V}$, $f=1\text{ MHz}$
Output capacitance ⁷⁾	C_{oss}		980	1300		
Reverse transfer capacitance ⁷⁾	C_{rss}		50	88		
Turn-on delay time	$t_{d(on)}$	-	4	-	ns	$V_{DD}=20\text{ V}$, $V_{GS}=10\text{ V}$, $I_D=20\text{ A}$, $R_{G,ext}=1.6\text{ }\Omega$
Rise time	t_r		2			
Turn-off delay time	$t_{d(off)}$		19			
Fall time	t_f		3			

⁷⁾ Defined by design. Not subject to production test.

Table 6 Gate charge characteristics ⁸⁾

Parameter	Symbol	Values			Unit	Note / Test condition
		Min.	Typ.	Max.		
Gate to source charge	Q_{gs}	-	7.1	-	nC	$V_{DD}=20\text{ V}$, $I_D=20\text{ A}$, $V_{GS}=0$ to 4.5 V
Gate charge at threshold	$Q_{g(th)}$	-	4.2	-	nC	
Gate to drain charge ⁹⁾	Q_{gd}	-	3.9	5.9	nC	
Switching charge	Q_{sw}	-	6.7	-	nC	
Gate charge total ⁹⁾	Q_g	-	18.9	24	nC	
Gate plateau voltage	$V_{plateau}$	-	2.4	-	V	
Gate charge total ⁹⁾	Q_g	-	39	52	nC	$V_{DD}=20\text{ V}$, $I_D=20\text{ A}$, $V_{GS}=0$ to 10 V
Gate charge total, sync. FET	$Q_{g(sync)}$	-	16.6	-	nC	$V_{DS}=0.1\text{ V}$, $V_{GS}=0$ to 10 V
Output charge ⁹⁾	Q_{oss}	-	43	57	nC	$V_{DS}=20\text{ V}$, $V_{GS}=0\text{ V}$

⁸⁾ See "Gate charge waveforms" for parameter definition

⁹⁾ Defined by design. Not subject to production test.

Table 7 Reverse diode

Parameter	Symbol	Values			Unit	Note / Test condition
		Min.	Typ.	Max.		
Diode continuous forward current	I_S	-	-	136	A	$T_C=25\text{ °C}$
Diode pulse current	$I_{S,pulse}$	-	-	1080		
Diode forward voltage	V_{SD}	-	0.74	1.0	V	$V_{GS}=0\text{ V}$, $I_F=20\text{ A}$, $T_J=25\text{ °C}$
Reverse recovery time ¹⁰⁾	t_{rr}	-	33	65	ns	$V_R=20\text{ V}$, $I_F=20\text{ A}$, $di_F/dt=100\text{ A}/\mu\text{s}$
Reverse recovery charge ¹⁰⁾	Q_{rr}	-	29	58	nC	
Reverse recovery time ¹⁰⁾	t_{rr}	-	23	46	ns	$V_R=20\text{ V}$, $I_F=20\text{ A}$, $di_F/dt=500\text{ A}/\mu\text{s}$
Reverse recovery charge ¹⁰⁾	Q_{rr}	-	87	174	nC	
Reverse recovery time ¹⁰⁾	t_{rr}	-	19	38	ns	$V_R=20\text{ V}$, $I_F=20\text{ A}$, $di_F/dt=1000\text{ A}/\mu\text{s}$
Reverse recovery charge ¹⁰⁾	Q_{rr}	-	124	249	nC	

¹⁰⁾ Defined by design. Not subject to production test.

4 Electrical characteristics diagrams

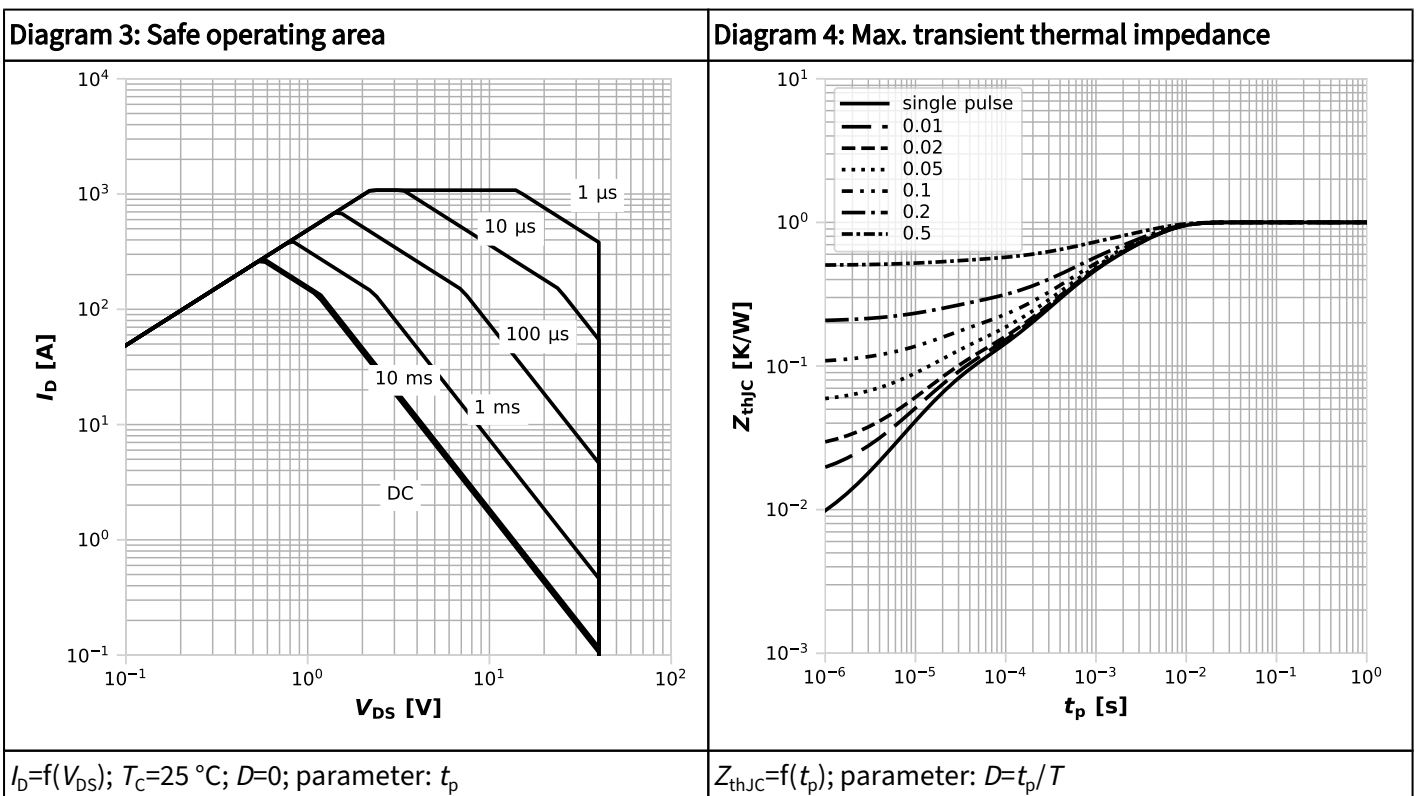
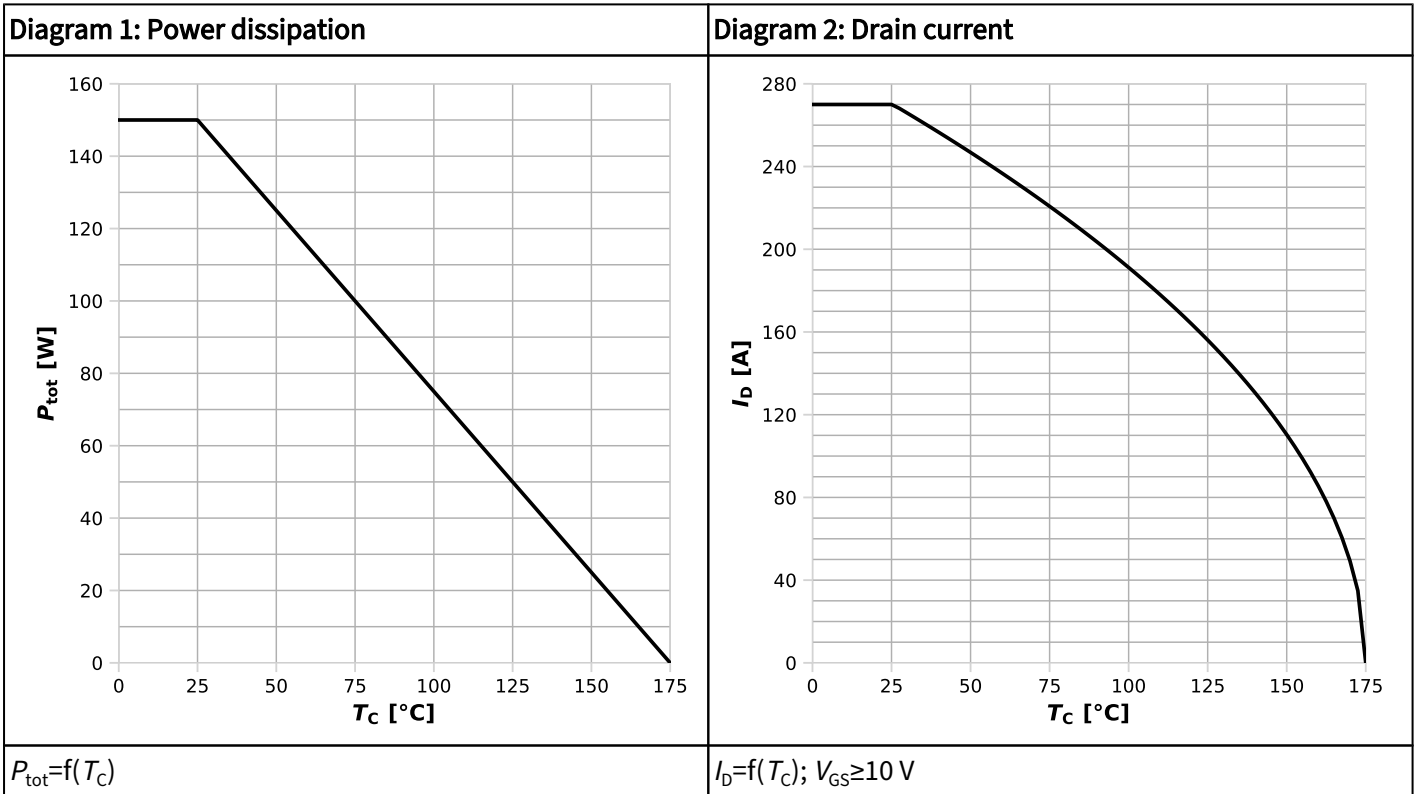
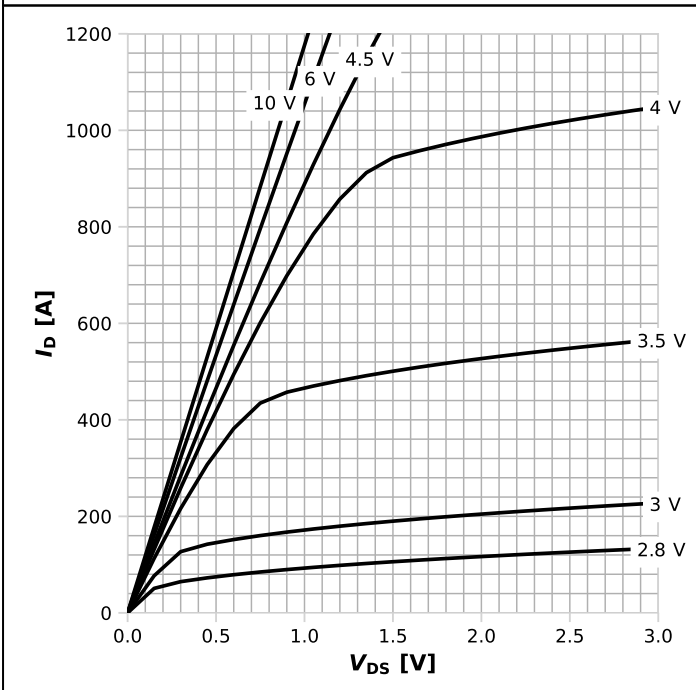
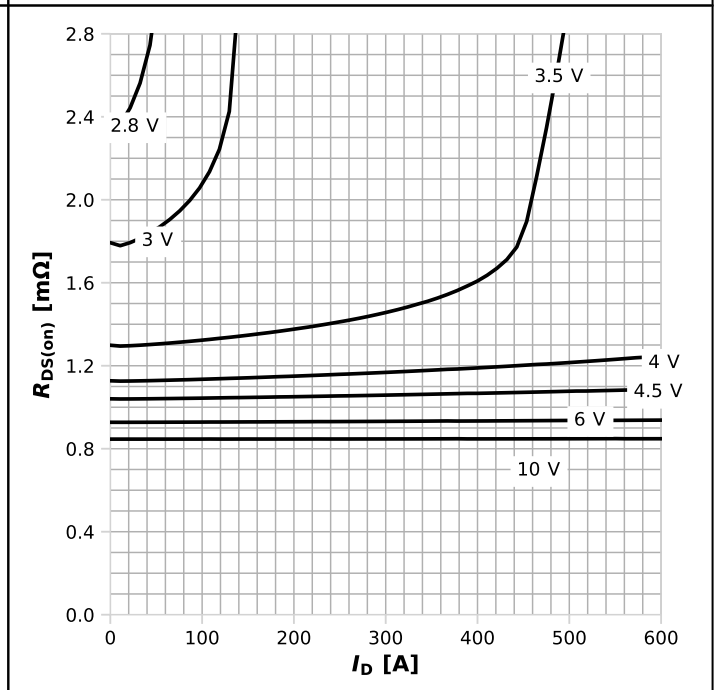

Diagram 5: Typ. output characteristics



$I_D = f(V_{DS}), T_j = 25\text{ °C};$ parameter: V_{GS}

Diagram 6: Typ. drain-source on resistance



$R_{DS(on)} = f(I_D), T_j = 25\text{ °C};$ parameter: V_{GS}

Diagram 7: Typ. transfer characteristics

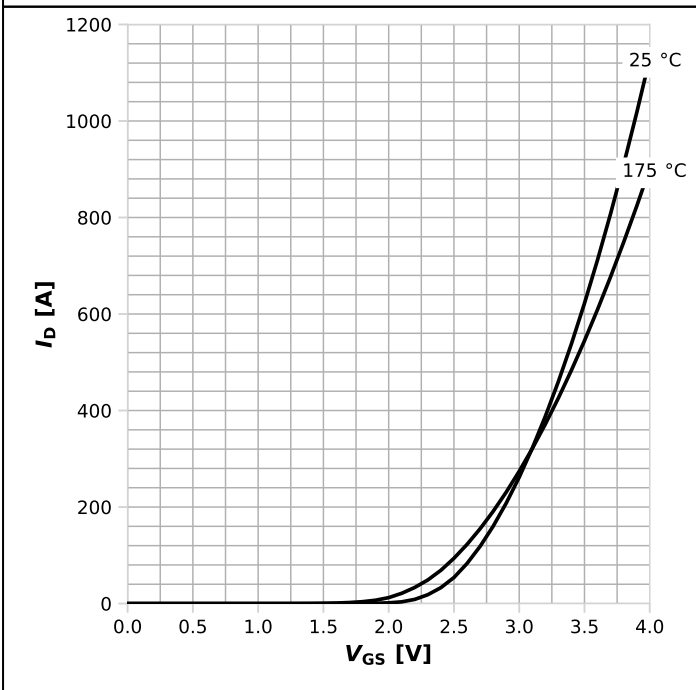

$I_D = f(V_{GS}), |V_{DS}| > 2|I_D|R_{DS(on)max};$ parameter: T_j

Diagram 8: Typ. drain-source on resistance

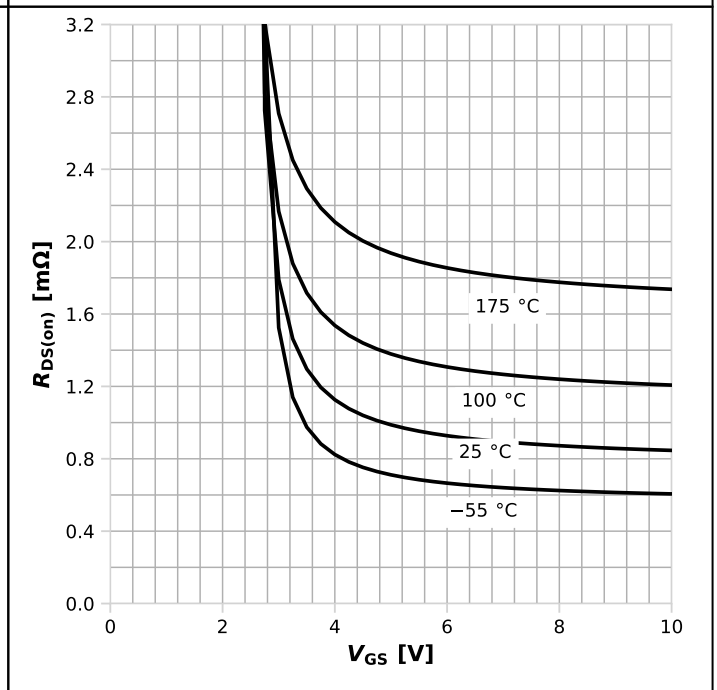

$R_{DS(on)} = f(V_{GS}), I_D = 20\text{ A};$ parameter: T_j

Diagram 9: Normalized drain-source on resistance

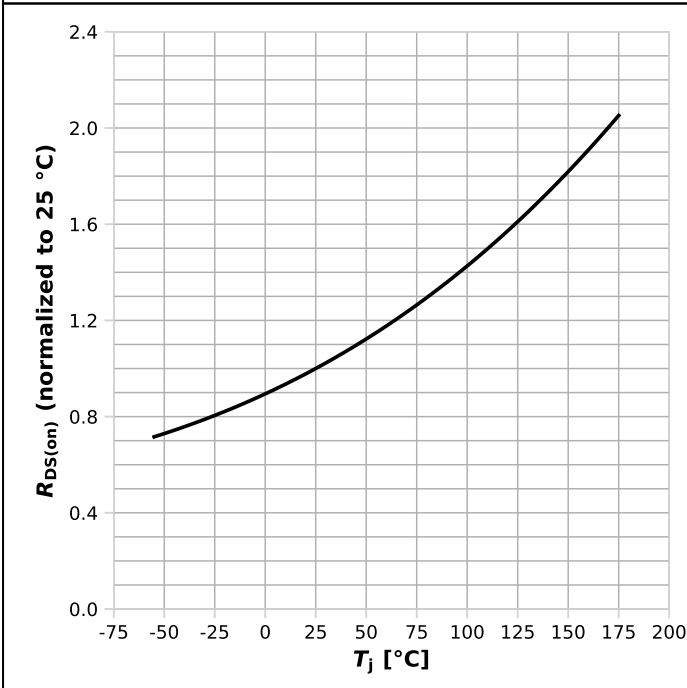

$R_{DS(on)}=f(T_j), I_D=20\text{ A}, V_{GS}=10\text{ V}$

Diagram 10: Typ. gate threshold voltage

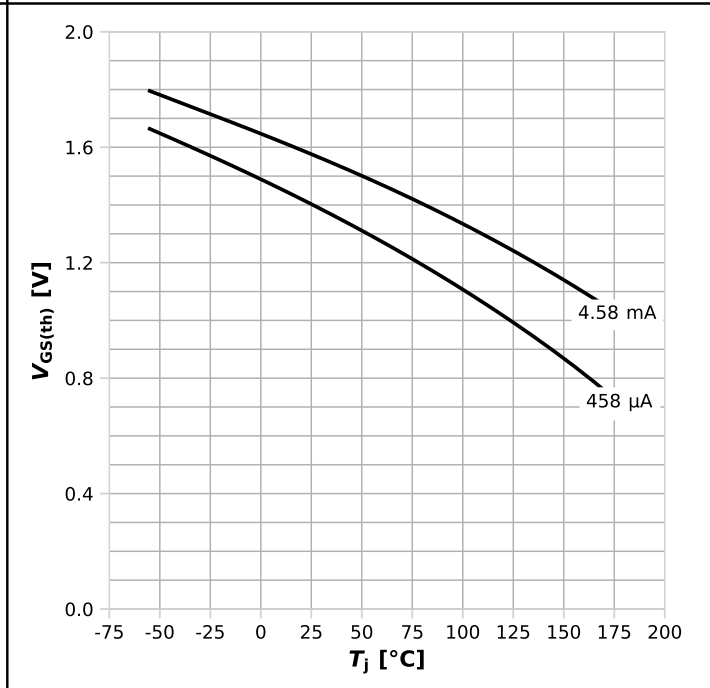

$V_{GS(th)}=f(T_j), V_{GS}=V_{DS}; \text{parameter: } I_D$

Diagram 11: Typ. capacitances

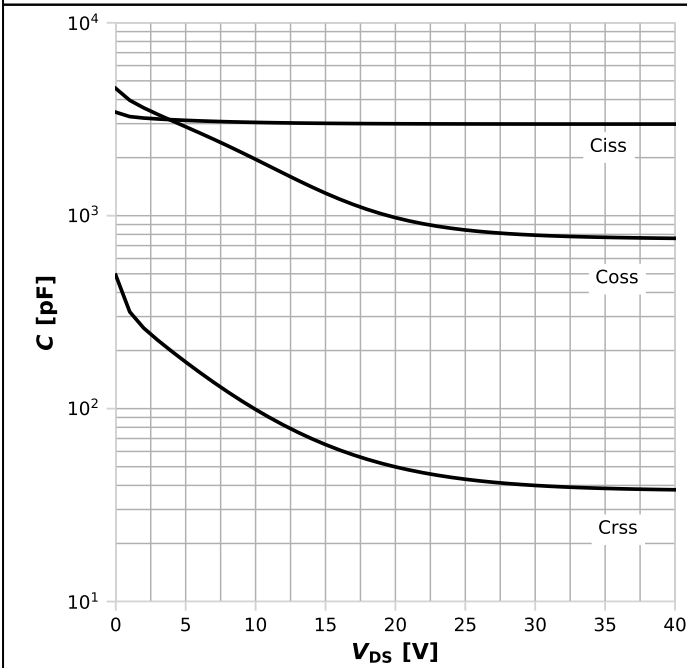

$C=f(V_{DS}); V_{GS}=0\text{ V}; f=1\text{ MHz}$

Diagram 12: Forward characteristics of reverse diode

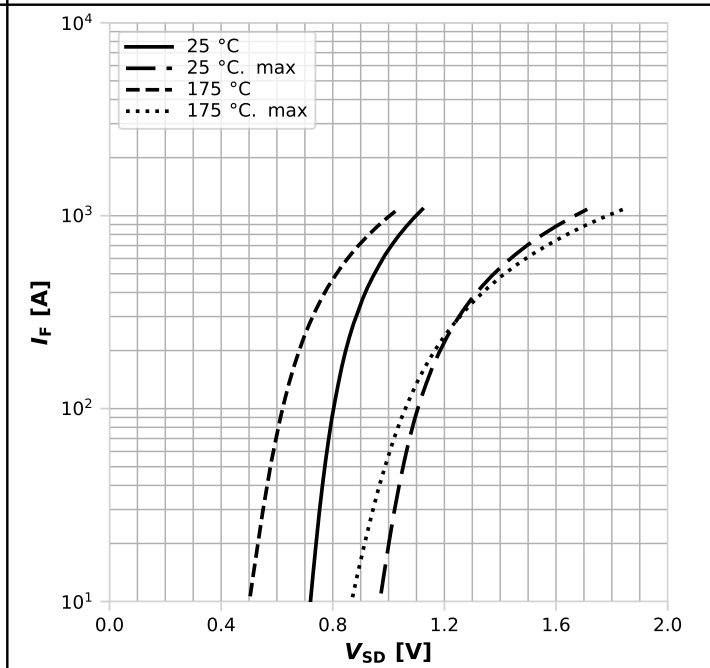

$I_F=f(V_{SD}); \text{parameter: } T_j$

Diagram 13: Avalanche characteristics

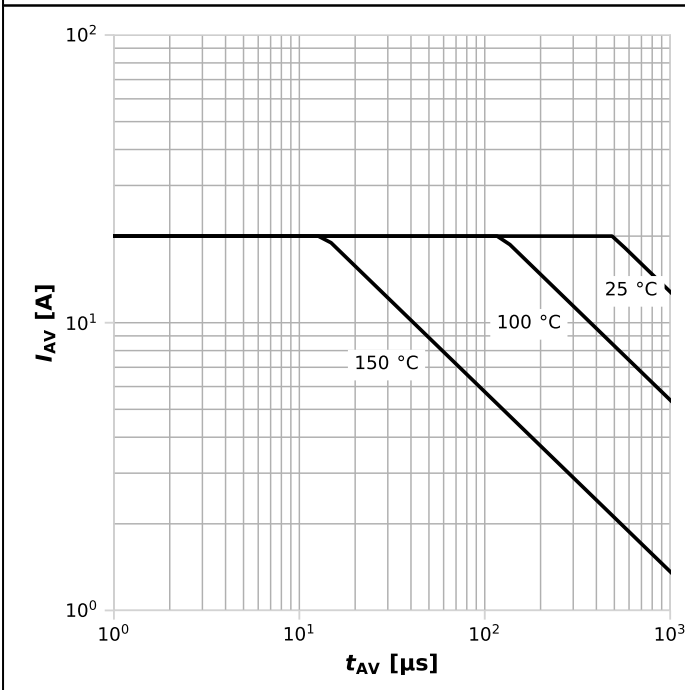

$I_{AS}=f(t_{AV}); R_{GS}=25 \Omega$; parameter: $T_{j,start}$

Diagram 14: Typ. gate charge

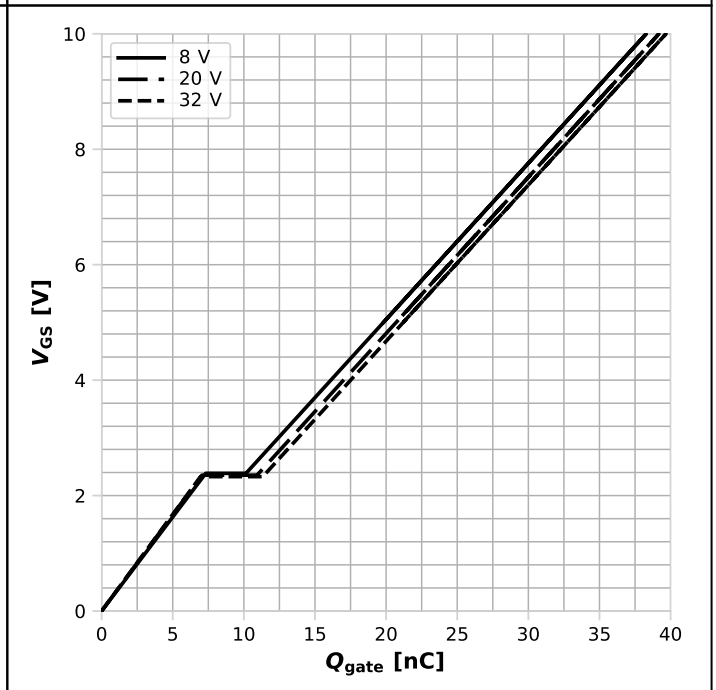

$V_{GS}=f(Q_{gate}), I_D=20$ A pulsed, $T_j=25$ °C; parameter: V_{DD}

Diagram 15: Min. drain-source breakdown voltage

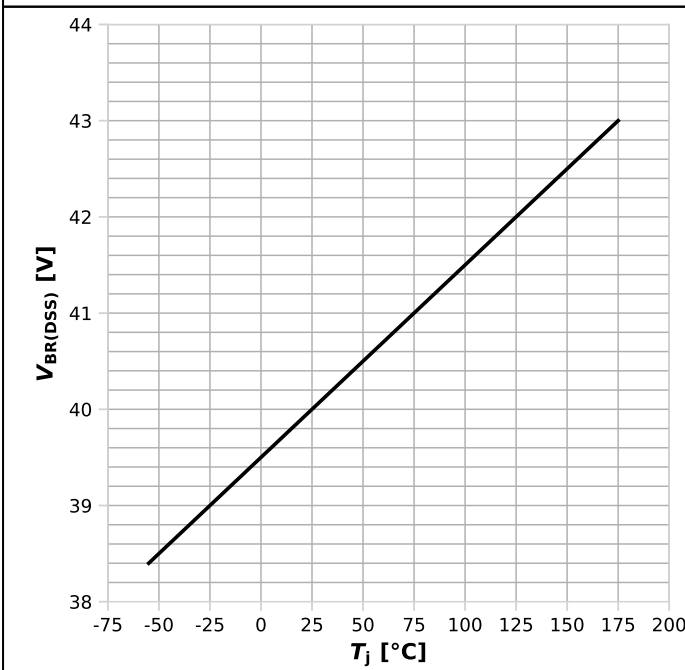

$V_{BR(DSS)}=f(T_j); I_D=1$ mA

Gate charge waveforms

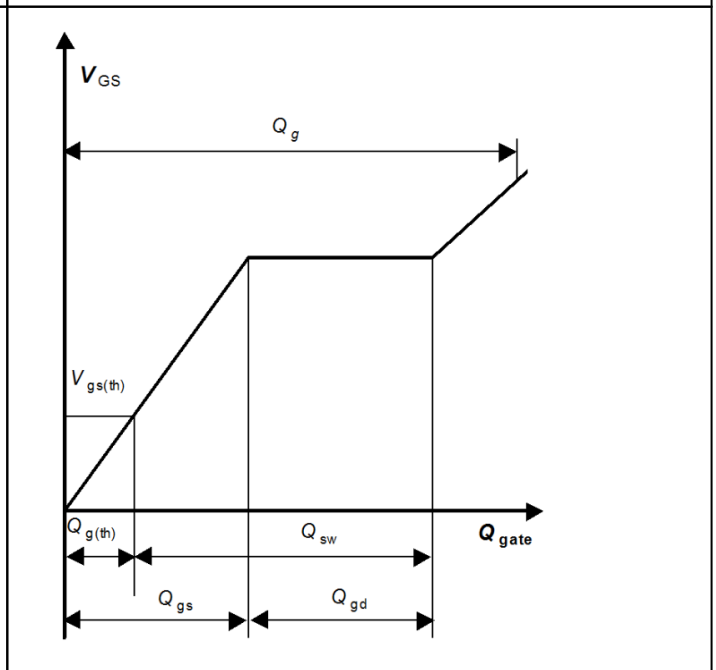

-

5 Package outlines

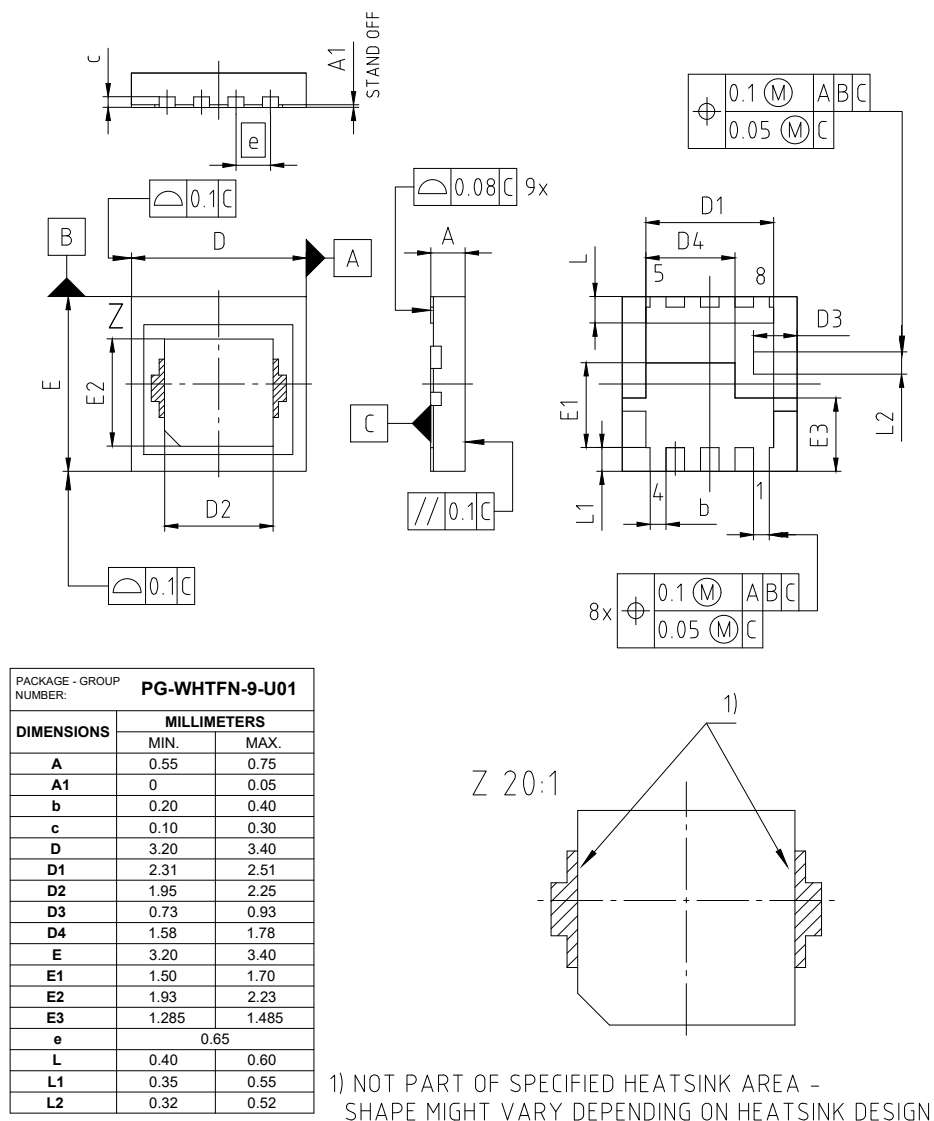

Figure 1 Outline PG-WHTFN-9, dimensions in mm

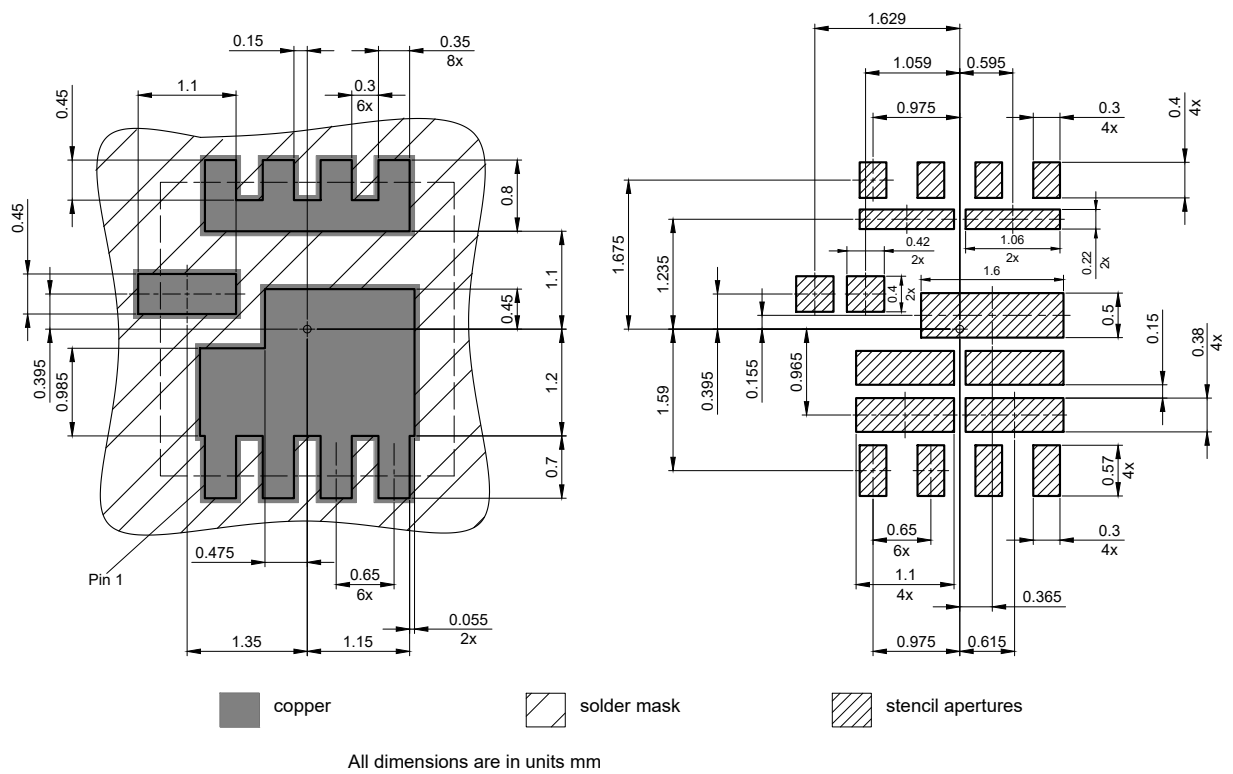

Figure 2 Footprint drawing PG-WHTFN-9, dimensions in mm

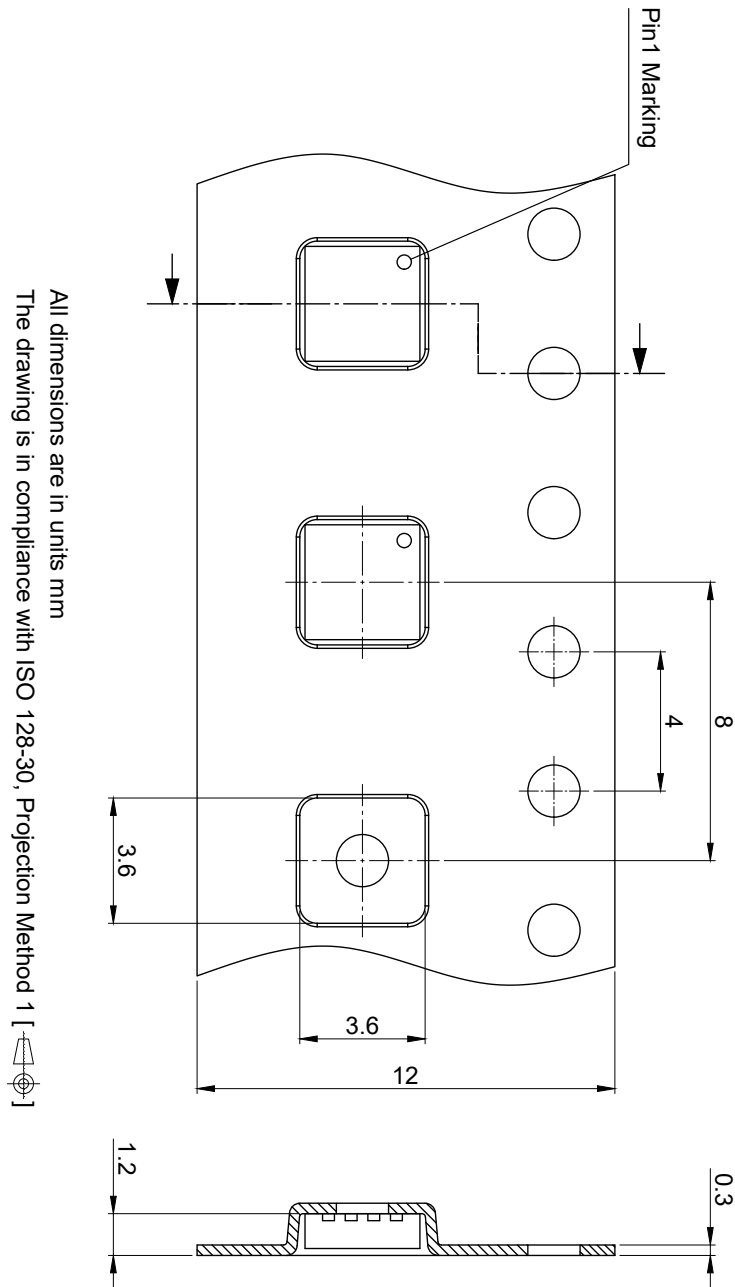

Figure 3 Packaging variant PG-WHTFN-9, dimensions in mm



Revision history

IQE010N04LM7CGSC

Revision 2026-02-09, Rev. 1.0

Previous revisions

Revision	Date	Subjects (major changes since last revision)
1.0	2026-02-09	Release of final datasheet

Trademarks

All referenced product or service names and trademarks are the property of their respective owners.

Published by Infineon Technologies AG, Am Campeon 1-15, 85579 Neubiberg, Germany
Copyright (c) 2026 Infineon Technologies AG and its affiliates. All Rights Reserved.

Important notice

Products which may also include samples and may be comprised of hardware or software or both ("Product(s)") are sold or provided and delivered by Infineon Technologies AG and its affiliates ("Infineon") subject to the terms and conditions of the frame supply contract or other written agreement(s) executed by a customer and Infineon or, in the absence of the foregoing, the applicable Sales Conditions of Infineon. General terms and conditions of a customer or deviations from applicable Sales Conditions of Infineon shall only be binding for Infineon if and to the extent Infineon has given its express written consent.

For the avoidance of doubt, Infineon disclaims all warranties of non-infringement of third-party rights and implied warranties such as warranties of fitness for a specific use/purpose or merchantability.

Infineon shall not be responsible for any information with respect to samples, the application or customer's specific use of any Product or for any examples or typical values given in this document.

The data contained in this document is exclusively intended for technically qualified and skilled customer representatives. It is the responsibility of the customer to evaluate the suitability of the Product for the intended application and the customer's specific use and to verify all relevant technical data contained in this document in the intended application and the customer's specific use. The customer is responsible for properly designing, programming, and testing the functionality and safety of the intended application, as well as complying with any legal requirements related to its use.

Unless otherwise explicitly approved by Infineon, Products may not be used in any application where a failure of the Products or any consequences of the use thereof can reasonably be expected to result in personal injury. However, the foregoing shall not prevent the customer from using any Product in such fields of use that Infineon has explicitly designed and sold it for, provided that the overall responsibility for the application lies with the customer.

Infineon expressly reserves the right to use its content for commercial text and data mining (TDM) according to applicable laws, e.g. Section 44b of the German Copyright Act (UrhG).

If the Product includes security features: Because no computing device can be absolutely secure, and despite security measures implemented in the Product, Infineon does not guarantee that the Product will be free from intrusion, data theft or loss, or other breaches ("Security Breaches"), and Infineon shall have no liability arising out of any Security Breaches.

If this document includes or references software:

The software is owned by Infineon under the intellectual property laws and treaties of the United States, Germany, and other countries worldwide. All rights reserved. Therefore, you may use the software only as provided in the software license agreement accompanying the software. If no software license agreement applies, Infineon hereby grants you a personal, non-exclusive, non-transferable license (without the right to sublicense) under its intellectual property rights in the software (a) for software provided in source code form, to modify and reproduce the software solely for use with Infineon hardware products, only internally within your organization, and (b) to distribute the software in binary code form externally to end users, solely for use on Infineon hardware products. Any other use, reproduction, modification, translation, or compilation of the software is prohibited.

For further information on the Product, technology, delivery terms and conditions, and prices, please contact your nearest Infineon office or visit <https://www.infineon.com>.