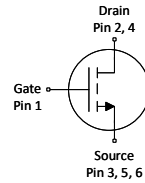
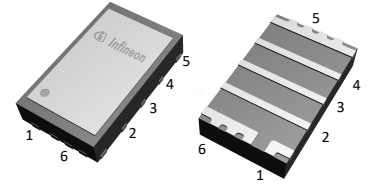


**CoolGaN™**  
**CoolGaN™ Transistor 175 V G3**

PG-TSON-6

**Features**

- Ultra fast switching and high efficiency
- Space saving and highly robust package
- No reverse recovery charge
- Ultra low gate charge and output charge
- Exposed die for top-side thermal excellence
- Moisture rating MSL1
- Industrial grade 3x5 package



Top side is exposed silicon substrate, internally connected to source terminal. Not recommended to use as an electrical connection.

**Potential applications**

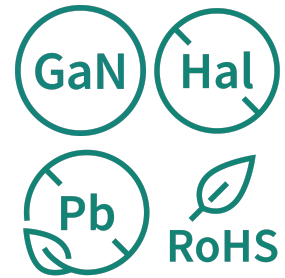
- Telecom & Datacenter
- Class D Audio
- Sync Rectification for AC-DC and DC-DC converters
- e-Mobility, UAVs
- Battery powered tools
- Solar & Energy storage systems

**Product validation**

Qualified according to relevant JEDEC tests.

**Table 1 Key performance parameters**

Parameter	Value	Unit
$V_{DS}$	175	V
$R_{DS(on)}$	6.7	mΩ
$I_D$	46	A
$Q_{oss}$	60	nC
$Q_G$	8.5	nC
$Q_{rr}$	0	nC



Part number	Package	Marking	Related links
IGC090S18S1	PG-TSON-6	90SJ1	see Appendix A

## Table of contents

Description .....	1
Maximum ratings .....	3
Recommended operating conditions .....	4
Thermal characteristics .....	5
Electrical Characteristics .....	6
Electrical characteristics diagrams .....	8
Package outlines .....	13
Appendix A .....	16
Revision history .....	17
Trademarks .....	18
Disclaimer .....	18

Preiminary

## 1 Maximum ratings

at  $T_j = 25\text{ °C}$ , unless otherwise specified. Stresses beyond max ratings may cause permanent damage to the device. For optimum lifetime and reliability, Infineon recommends operating conditions that do not continuously exceed 80 % of the maximum ratings stated (unless otherwise explicitly stated). For further information, contact your local Infineon sales office.

**Table 2 Maximum ratings**

Parameter	Symbol	Values			Unit	Note / Test condition
		Min.	Typ.	Max.		
Continuous drain-source voltage	$V_{DS}$	-	-	175	V	$V_{GS}=0\text{ V}$
Pulsed drain-source voltage <sup>1)</sup>	$V_{DS,pulse}$	-	-	210	V	$V_{GS}=0\text{ V}$ , 1 h total time
Continuous drain current	$I_D$	-	-	46	A	$V_{GS}=5\text{ V}$ , $T_C=25\text{ °C}$
				12		$V_{GS}=5\text{ V}$ , $T_A=25\text{ °C}$ , $R_{thJA}=38\text{ °C/W}$ <sup>2)</sup>
Pulsed drain current <sup>3)</sup>	$I_{D,pulse}$	-	-	340	A	$T_j=25\text{ °C}$
				210		$T_j=150\text{ °C}$
Pulsed gate-source voltage <sup>1)</sup>	$V_{GS}$	-6.5	-	6.5	V	Pulsed 100 h total time
Power dissipation	$P_{tot}$	-	-	45	W	$T_C=25\text{ °C}$
				3.3		$T_A=25\text{ °C}$ , $R_{thJA}=38\text{ °C/W}$ <sup>2)</sup>
Storage temperature	$T_{stg}$	-55	-	150	°C	-
Junction temperature	$T_j$	-40	-			

<sup>1)</sup> Provided as measure of robustness under abnormal operating conditions and not recommended for normal operation.

<sup>2)</sup> Device on 4-layer FR4 PCB, vertical in still air.

<sup>3)</sup> Pulse current limited by transfer characteristic.

## 2 Recommended operating conditions

**Table 3 Recommended operating conditions**

Parameter	Symbol	Values			Unit	Note / Test condition
		Min.	Typ.	Max.		
Gate-source voltage	$V_{GS}$	-4.0	5.0	5.5	V	-

Preliminary

### 3 Thermal characteristics

**Table 4 Thermal characteristics**

Parameter	Symbol	Values			Unit	Note / Test condition
		Min.	Typ.	Max.		
Thermal resistance, junction - case, top	$R_{thJC}$	-	0.5	0.6	°C/W	-
Thermal resistance, junction - case, bottom		-	1.9	2.8		
Thermal resistance, junction - ambient 1s0p	$R_{thJA}$	-	60	-	°C/W	On 1 layer PCB, vertical in still air.
Thermal resistance, junction - ambient 2s2p	$R_{thJA}$	-	38	-	°C/W	With vias on 4 layer PCB, vertical in still air.

## 4 Electrical Characteristics

at  $T_j=25\text{ °C}$ , unless otherwise specified

**Table 5 Static characteristics**

Parameter	Symbol	Values			Unit	Note / Test condition
		Min.	Typ.	Max.		
Gate threshold voltage	$V_{GS(th)}$	1.2	2.0	2.9	V	$V_{DS}=V_{GS}$ , $I_D=5.0\text{ mA}$
Drain-source leakage current	$I_{DSS}$	-	0.25	-	$\mu\text{A}$	$V_{DS}=140\text{ V}$ , $V_{GS}=0\text{ V}$ , $T_j=25\text{ °C}$
			3.0			$V_{DS}=140\text{ V}$ , $V_{GS}=0\text{ V}$ , $T_j=125\text{ °C}$
Gate-source leakage current	$I_{GSS}$	-	18	-	$\mu\text{A}$	$V_{GS}=5\text{ V}$ , $T_j=25\text{ °C}$
			0.01			$V_{GS}=-4\text{ V}$ , $T_j=25\text{ °C}$
			150			$V_{GS}=5\text{ V}$ , $T_j=125\text{ °C}$
			0.01			$V_{GS}=-4\text{ V}$ , $T_j=125\text{ °C}$
Drain-source on-state resistance	$R_{DS(on)}$	-	6.7	9.0	m $\Omega$	$V_{GS}=5\text{ V}$ , $I_D=10\text{ A}$
Gate resistance <sup>4)</sup>	$R_G$	-	0.5	-	$\Omega$	-

<sup>4)</sup> Defined by design. Not subject to production test.

**Table 6 Capacitance characteristics <sup>5)</sup>**

Parameter	Symbol	Values			Unit	Note / Test condition
		Min.	Typ.	Max.		
Input capacitance	$C_{iss}$	-	800	-	pF	$V_{GS}=0\text{ V}$ , $V_{DS}=87.5\text{ V}$ , $f=1\text{ MHz}$
Output capacitance	$C_{oss}$		420			
Reverse transfer capacitance	$C_{rss}$		3.8			

<sup>5)</sup> Defined by design. Not subject to production test.

**Table 7 Gate charge characteristics**

Parameter	Symbol	Values			Unit	Note / Test condition
		Min.	Typ.	Max.		
Gate to source charge	$Q_{gs}$	-	2.0	-	nC	$V_{DS}=87.5\text{ V}$ , $I_D=10\text{ A}$ , $V_{GS}=0\text{ to }5\text{ V}$
Gate charge at threshold	$Q_{g(th)}$		1.6		nC	
Gate to drain charge <sup>6)</sup>	$Q_{gd}$		2.1		nC	
Switching charge	$Q_{sw}$		2.5		nC	
Gate charge total <sup>6)</sup>	$Q_g$		8.5		nC	
Gate plateau voltage	$V_{plateau}$		2.5		V	
Output charge <sup>6)</sup>	$Q_{oss}$		-		60	

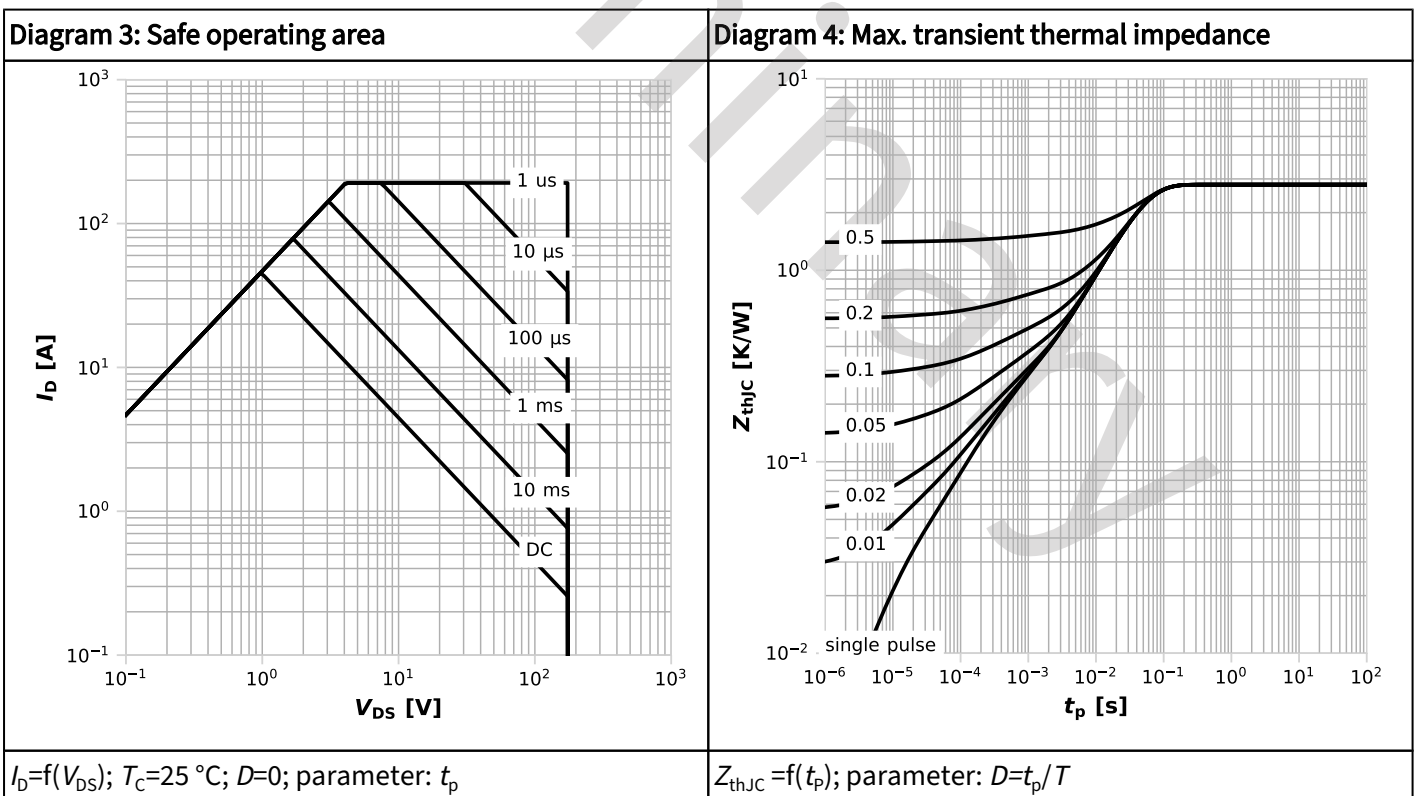
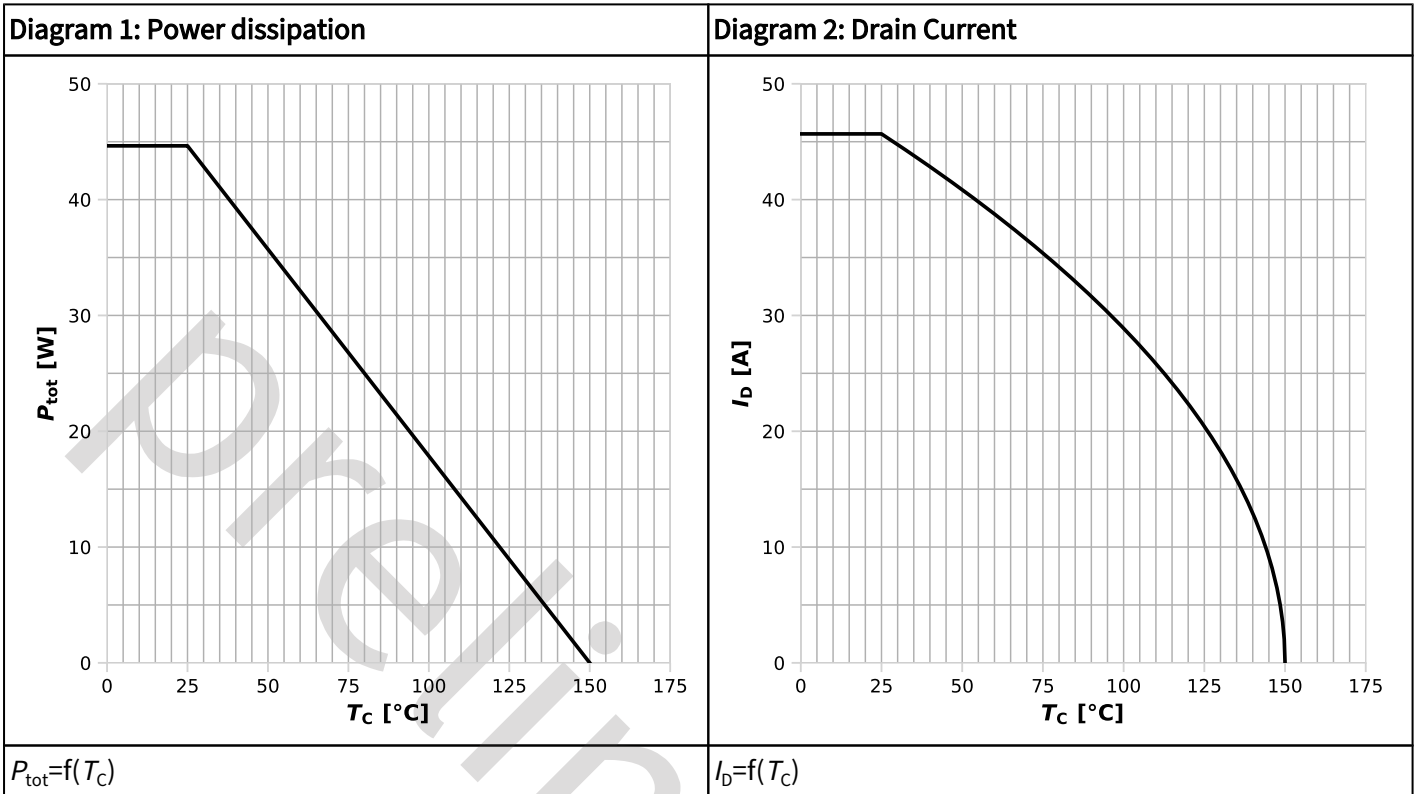
<sup>6)</sup> Defined by design. Not subject to production test.

**Table 8 Reverse operation**

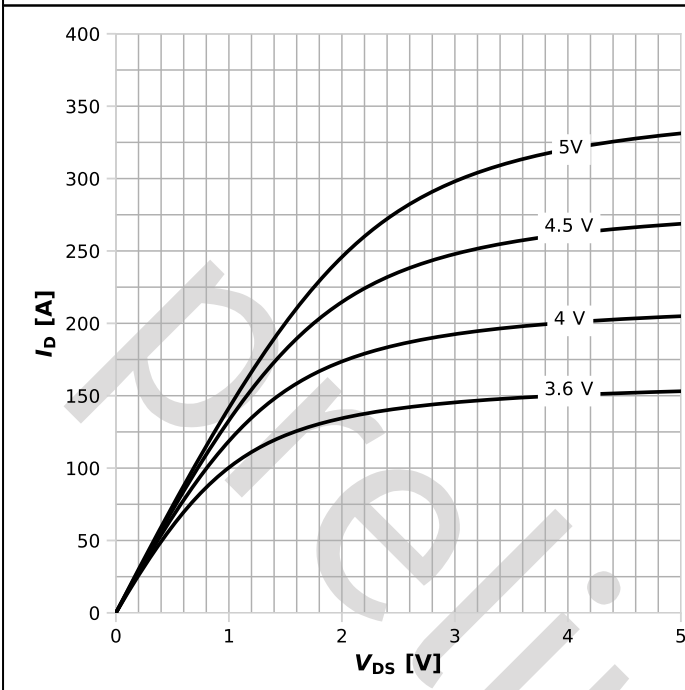
Parameter	Symbol	Values			Unit	Note / Test condition
		Min.	Typ.	Max.		
Reverse continuous current	$I_S$	-	-	15	A	$T_C=25\text{ °C}$
Pulsed current, reverse	$I_{S,pulse}$	-	-	184		
Source-Drain reverse voltage	$V_{SD}$	-	2.3	-	V	$V_{GS}=0\text{ V}, I_{S,pulse}=10\text{ A}, T_j=25\text{ °C}$
			2.0			$V_{GS}=0\text{ V}, I_{S,pulse}=0.5\text{ A}, T_j=25\text{ °C}$
Reverse recovery charge <sup>7)</sup>	$Q_{rr}$	-	0	-	nC	$V_R=87.5\text{ V}, I_{S,pulse}=10\text{ A}, di_{S,pulse}/dt=100\text{ A}/\mu\text{s}$

<sup>7)</sup> Defined by design. Not subject to production test.

## 5 Electrical characteristics diagrams

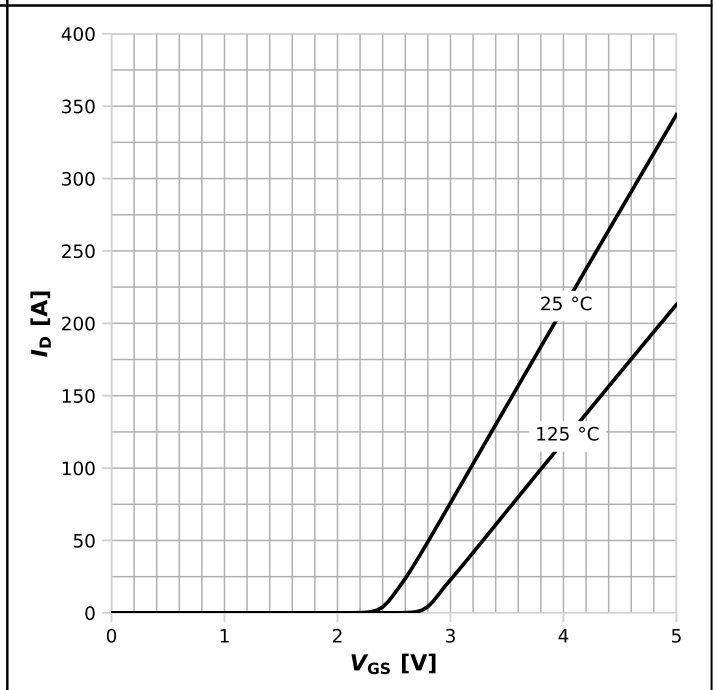


**Diagram 5: Typ. output characteristics**



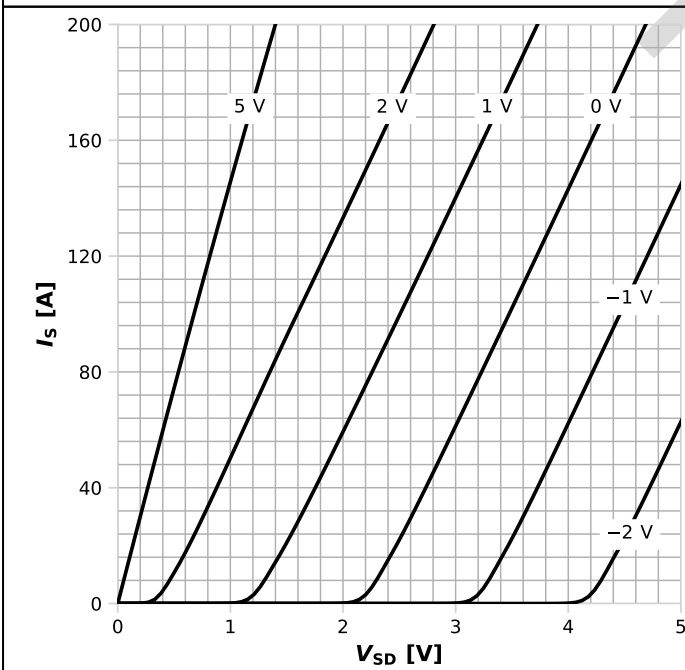
$I_D = f(V_{DS}); T_j = 25\text{ °C};$  parameter:  $V_{GS}$

**Diagram 6: Typ. transfer characteristics**



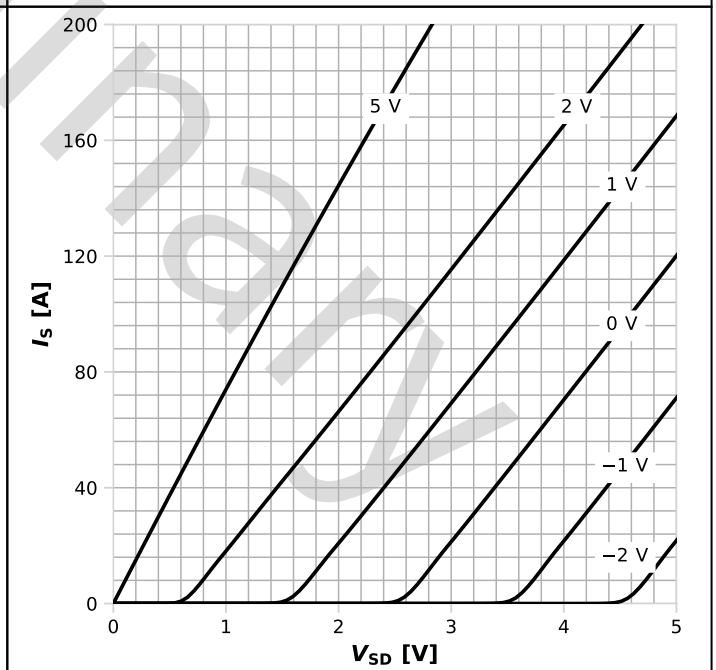
$I_D = f(V_{GS}); |V_{DS}| > 2|I_D|R_{DS(on)max};$  parameter:  $T_j$

**Diagram 7: Typ. channel reverse characteristics**



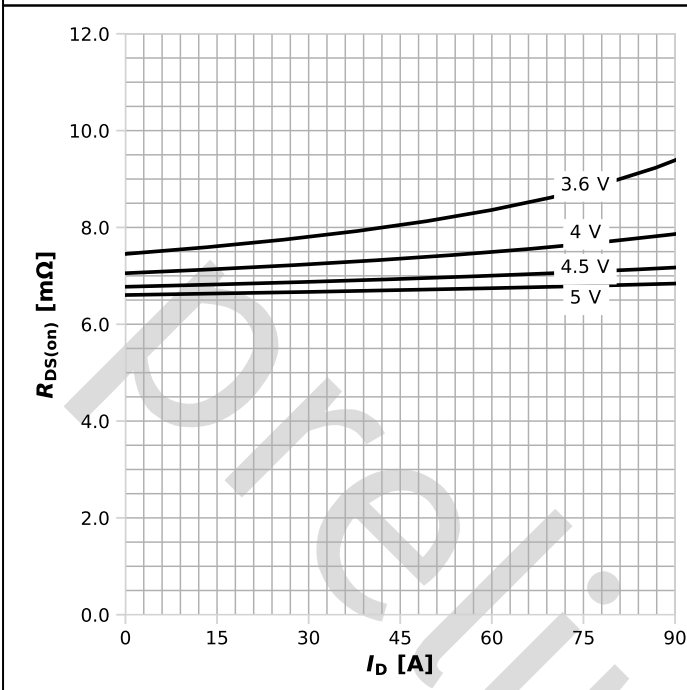
$I_S = f(V_{SD}); T_j = 25\text{ °C};$  parameter:  $V_{GS}$

**Diagram 8: Typ. channel reverse characteristics**



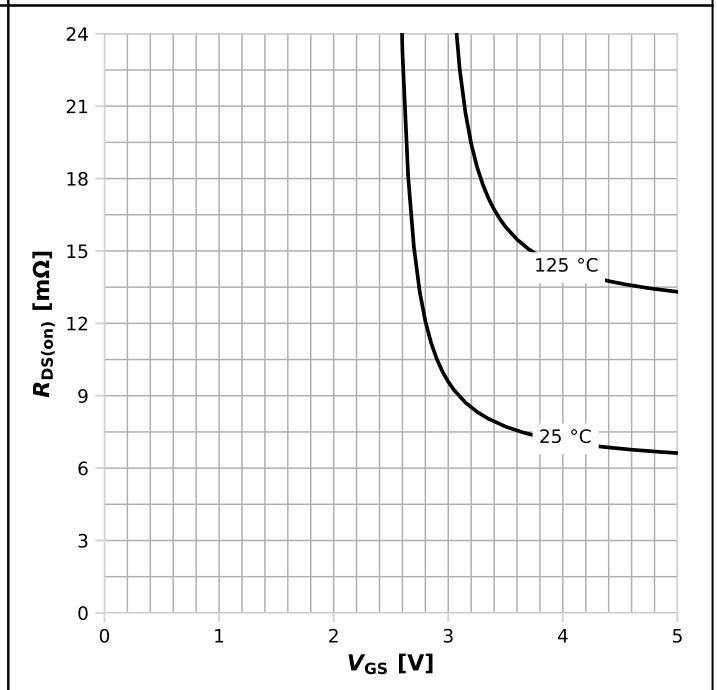
$I_S = f(V_{SD}); T_j = 125\text{ °C};$  parameter:  $V_{GS}$

Diagram 9: Typ. drain-source on-state resistance



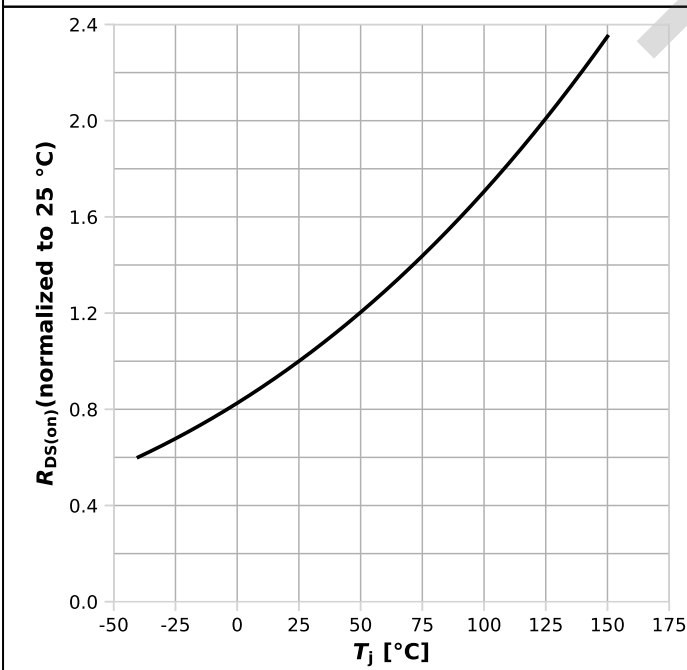
$R_{DS(on)}=f(I_D); T_j=25\text{ }^\circ\text{C}; \text{parameter: } V_{GS}$

Diagram 10: Typ. drain-source on-state resistance



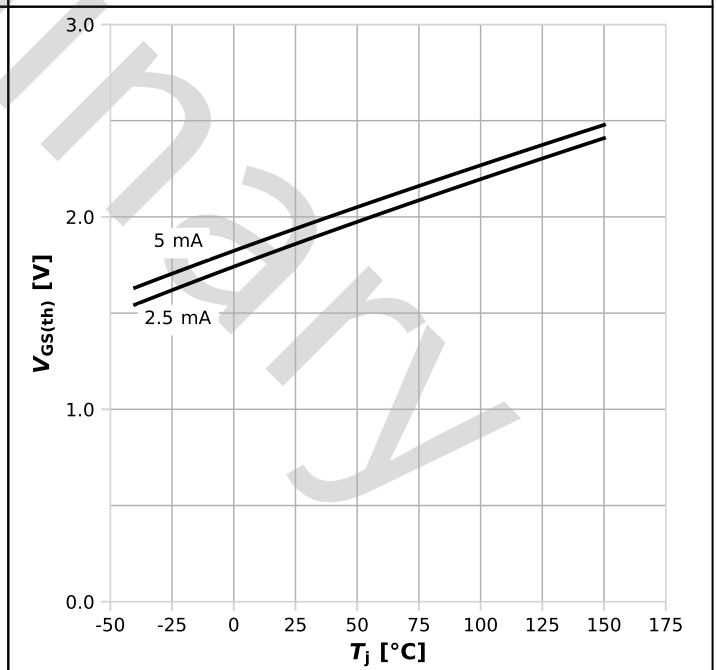
$R_{DS(on)}=f(V_{GS}); I_D=10\text{ A}; \text{parameter: } T_j$

Diagram 11: Drain-source on-state resistance



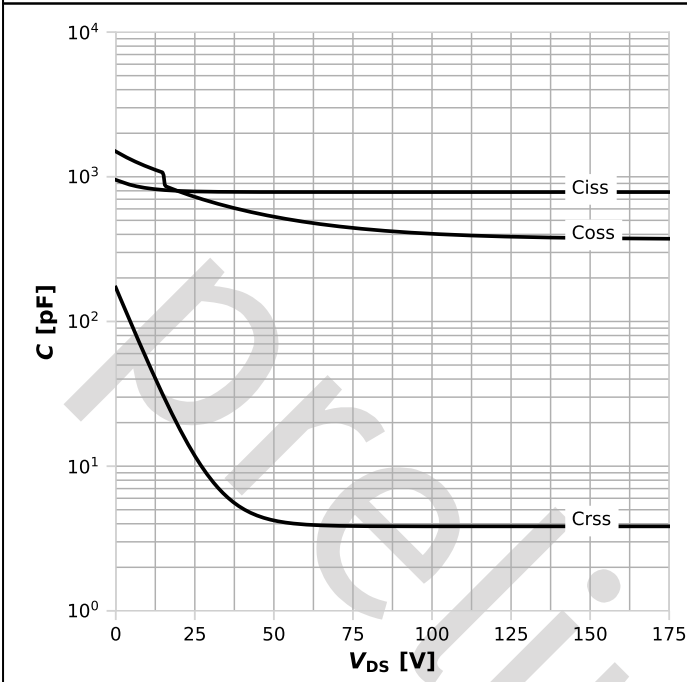
$R_{DS(on)}=f(T_j); I_D=10\text{ A}, V_{GS}=5\text{ V}$

Diagram 12: Typ. gate threshold voltage



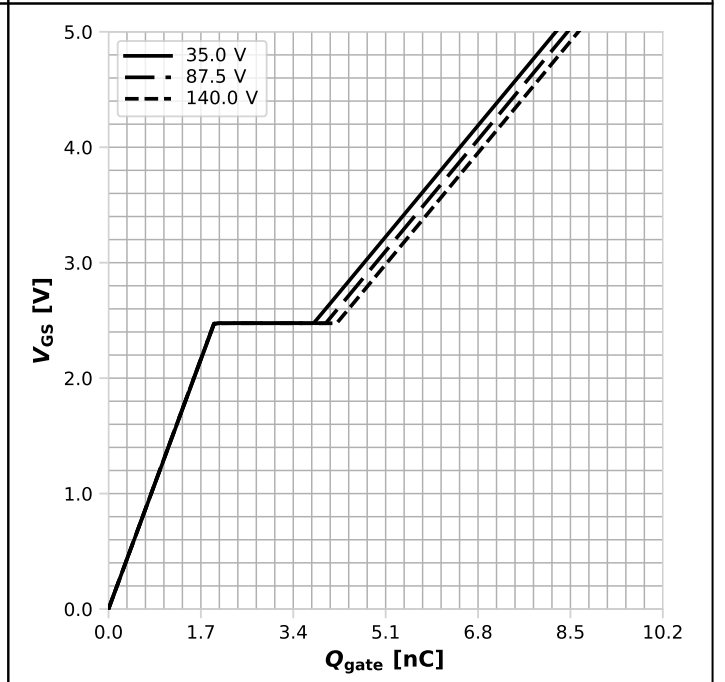
$V_{GS(th)}=f(T_j), V_{GS}=V_{DS}; \text{parameter: } I_D$

Diagram 13: Typ. capacitances



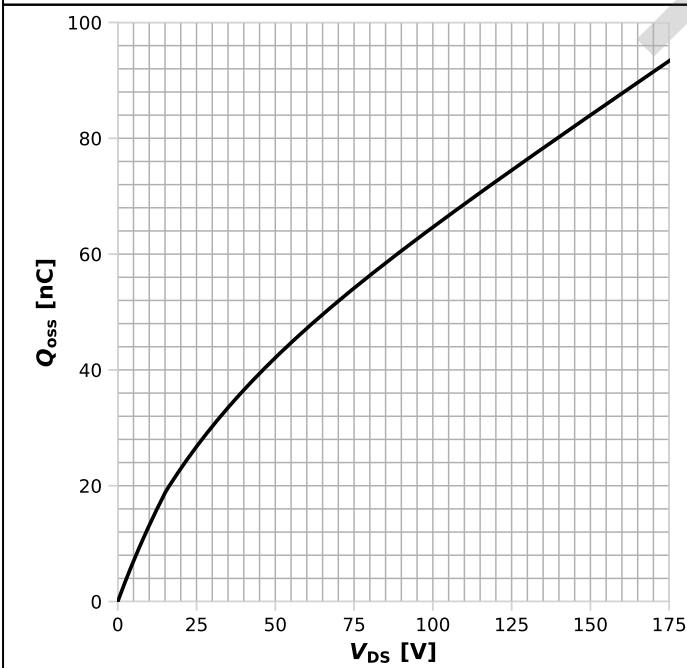
$C=f(V_{DS}); V_{GS}=0\text{ V}$

Diagram 14 Typ. gate charge



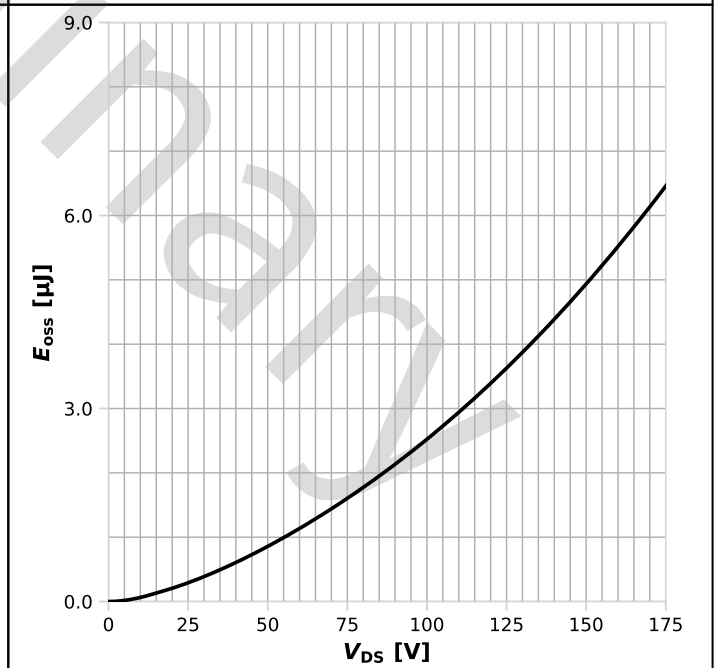
$V_{GS}=f(Q_{gate}); I_D=10\text{ A pulsed}; \text{parameter: } V_{DS}$

Diagram 15: Typ. output charge

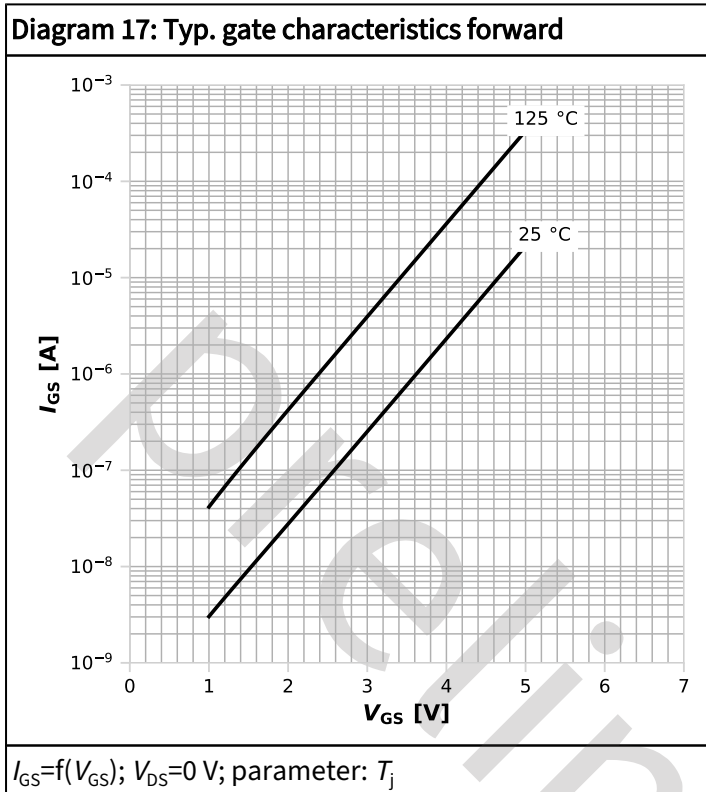


$Q_{oss}=f(V_{DS}), V_{GS}=0\text{ V}$

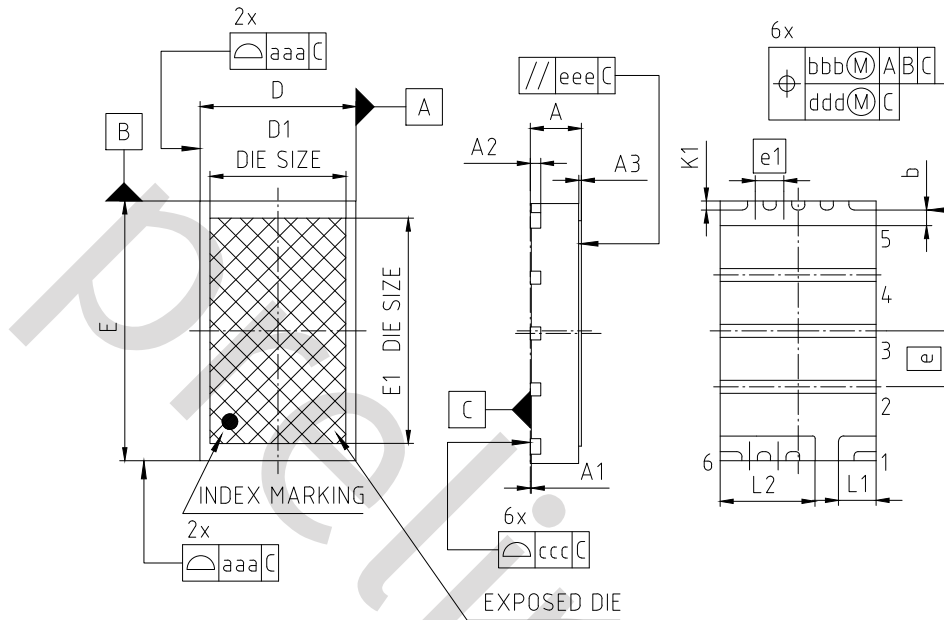
Diagram 16: Typ. Coss stored Energy



$E_{oss}=f(V_{DS}), V_{GS}=0\text{ V}$



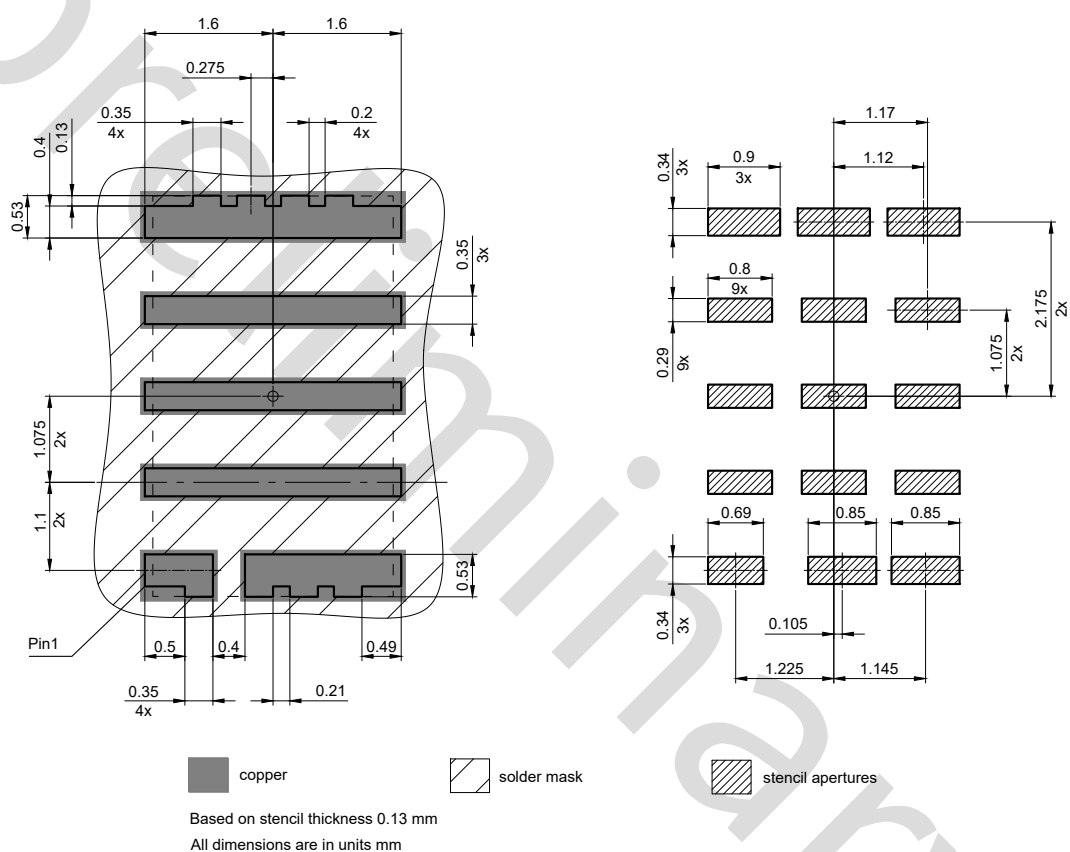
## 6 Package outlines



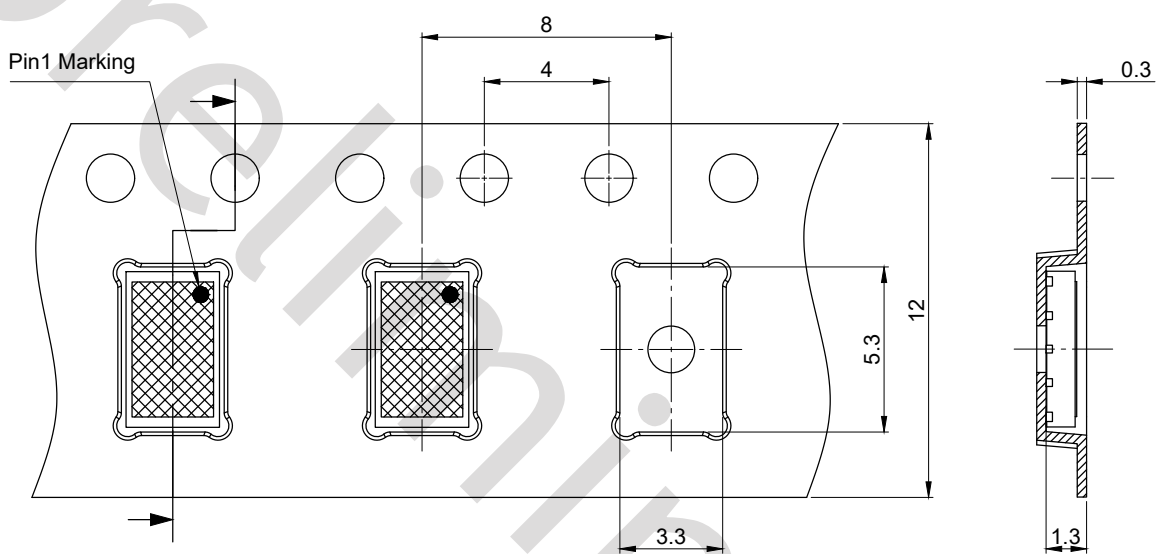
PACKAGE - GROUP NUMBER: PG-TSON-6-U01		
DIMENSIONS	MILLIMETERS	
	MIN.	MAX.
A	-	1.032
A1	-	0.05
A2	0.20	
A3	-	0.05
b	0.18	0.30
D	2.90	3.10
D1	2.616	
E	4.90	5.10
E1	4.336	
e	1.075	
e1	0.55	
K1	0.125	0.225
L1	0.625	0.825
L2	1.725	1.925
aaa	0.05	
bbb	0.10	
ccc	0.08	
ddd	0.05	
eee	0.10	

NOTE:  
DIMENSIONS DO NOT INCLUDE MOLD FLASH,  
PROTRUSION OR GATE BURRS

Figure 1 Outline PG-TSON-6, dimensions in mm



**Figure 2 Footprint drawing PG-TSON-6, dimensions in mm**



All dimensions are in units mm  
The drawing is in compliance with ISO 128-30, Projection Method 1 [  ]

Figure 3 Packaging variant PG-TSON-6, dimensions in mm

## 7 Appendix A

**Table 9** Related links

- [IFX CoolGaN™ GaN webpage](#)
- [IFX CoolGaN™ reliability white paper](#)
- [IFX CoolGaN™ gate driver application note](#)
- [IFX CoolGaN™ Evaluation Boards](#)
- [IFX Packages Description-PG-TSON-6-2](#)

Preliminary

## Revision history

IGC090S18S1

### Revision 2025-12-15, Rev. 0.2

Previous revisions

Revision	Date	Subjects (major changes since last revision)
0.1	2025-12-15	Release of preliminary version
0.2	2025-12-15	Updated marking

Preliminary

#### Trademarks

All referenced product or service names and trademarks are the property of their respective owners.

Published by Infineon Technologies AG, Am Campeon 1-15, 85579 Neubiberg, Germany  
Copyright (c) 2025 Infineon Technologies AG and its affiliates. All Rights Reserved.

#### Important notice

The product is not developed and released for series supply by Infineon.  
Subject to the development and release of the product for series supply by Infineon, the technical specifications of the product are set forth in the relevant final product data sheet provided by Infineon.

Infineon reserves the right to change all information given in this document at any time without notice.

Products which may also include samples and may be comprised of hardware or software or both ("Product(s)") are sold or provided and delivered by Infineon Technologies AG and its affiliates ("Infineon") subject to the terms and conditions of the frame supply contract or other written agreement(s) executed by a customer and Infineon or, in the absence of the foregoing, the applicable Sales Conditions of Infineon. General terms and conditions of a customer or deviations from applicable Sales Conditions of Infineon shall only be binding for Infineon if and to the extent Infineon has given its express written consent.

For the avoidance of doubt, Infineon disclaims all warranties of non-infringement of third-party rights and implied warranties such as warranties of fitness for a specific use/purpose or merchantability.

Infineon shall not be responsible for any information with respect to samples, the application or customer's specific use of any Product or for any examples or typical values given in this document.

The data contained in this document is exclusively intended for technically qualified and skilled customer representatives. It is the responsibility of the customer to evaluate the suitability of the Product for the intended application and the customer's specific use and to verify all relevant technical data contained in this document in the intended application and the customer's specific use. The customer is responsible for properly designing, programming, and testing the functionality and safety of the intended application, as well as complying with any legal requirements related to its use.

Unless otherwise explicitly approved by Infineon, Products may not be used in any application where a failure of the Products or any consequences of the use thereof can reasonably be expected to result in personal injury. However, the foregoing shall not prevent the customer from using any Product in such fields of use that Infineon has explicitly designed and sold it for, provided that the overall responsibility for the application lies with the customer.

Infineon expressly reserves the right to use its content for commercial text and data mining (TDM) according to applicable laws, e.g. Section 44b of the German Copyright Act (UrhG).

If the Product includes security features: Because no computing device can be absolutely secure, and despite security measures implemented in the Product, Infineon does not guarantee that the Product will be free from intrusion, data theft or loss, or other breaches ("Security Breaches"), and Infineon shall have no liability arising out of any Security Breaches.

If this document includes or references software:

The software is owned by Infineon under the intellectual property laws and treaties of the United States, Germany, and other countries worldwide. All rights reserved. Therefore, you may use the software only as provided in the software license agreement accompanying the software. If no software license agreement applies, Infineon hereby grants you a personal, non-exclusive, non-transferable license (without the right to sublicense) under its intellectual property rights in the software (a) for software provided in source code form, to modify and reproduce the software solely for use with Infineon hardware products, only internally within your organization, and (b) to distribute the software in binary code form externally to end users, solely for use on Infineon hardware products. Any other use, reproduction, modification, translation, or compilation of the software is prohibited.

For further information on the Product, technology, delivery terms and conditions, and prices, please contact your nearest Infineon office or visit <https://www.infineon.com>.