

英飞凌功率MOSFET

英飞凌BSC0902NSI OptiMOS™ 30 V N沟道功率MOSFET

特性

- 针对高性能降压转换器优化了SyncFET
- 集成肖特基类二极管
- 极低导通电阻 $R_{DS(on)}$ @ $V_{GS} = 4.5\text{ V}$
- 100% 雪崩测试
- 卓越的耐热性
- N沟道
- 符合 JEDEC ¹⁾ 目标应用要求
- 无铅镀层；符合RoHS标准
- 符合 IEC61249-2-21 标准的无卤素



表 1 主要性能参数

Parameter	Value	Unit
V_{DS}	30	V
$R_{DS(on),max}$	2.8	mΩ
I_b	100	A
Q_{oss}	17	nC
$Q_G(0V..10V)$	24	nC

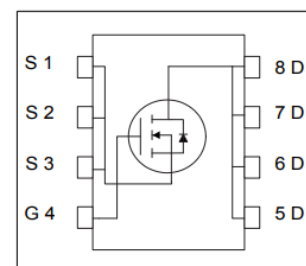
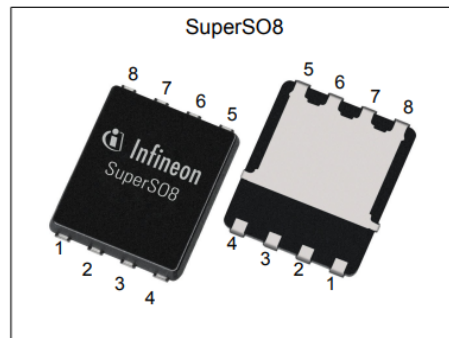

Type / Ordering Code	Package	Marking	Related Links
BSC0902NSI	PG-TDSON-8	0902NSI	-

¹⁾ J-STD20 和 JESD22

本数据手册的原文使用英文撰写。为方便起见，英飞凌提供了译文；由于翻译过程中可能使用了自动化工具，英飞凌不保证译文的准确性。为确认准确性请务必访问 infineon.com 参考最新的英文版本（控制文档）。

目录

描述	1
最大额定值	3
热特性	3
电气特性	4
电气特性图	6
封装外形	10
修订历史	13
商标	13
免责声明	13

1 最大额定值

除非另有规定, $T_A = 25\text{ °C}$

表 2 最大额定值

Parameter	Symbol	Values			Unit	Note / Test Condition
		Min.	Typ.	Max.		
Continuous drain current	I_D	-	-	100 65 89 56 23	A	$V_{GS}=10\text{ V}$, $T_C=25\text{ °C}$ $V_{GS}=10\text{ V}$, $T_C=100\text{ °C}$ $V_{GS}=4.5\text{ V}$, $T_C=25\text{ °C}$ $V_{GS}=4.5\text{ V}$, $T_C=100\text{ °C}$ $V_{GS}=10\text{ V}$, $T_A=25\text{ °C}$, $R_{thJA}=50\text{ K/W}^{1)}$
Pulsed drain current ²⁾	$I_{D,pulse}$	-	-	400	A	$T_C=25\text{ °C}$
Avalanche current, single pulse ³⁾	I_{AS}	-	-	50	A	$T_C=25\text{ °C}$
Avalanche energy, single pulse	E_{AS}	-	-	30	mJ	$I_D=40\text{ A}$, $R_{GS}=25\text{ }\Omega$
Gate source voltage	V_{GS}	-20	-	20	V	-
Power dissipation	P_{tot}	-	-	48 2.5	W	$T_C=25\text{ °C}$ $T_A=25\text{ °C}$, $R_{thJA}=50\text{ K/W}^{1)}$
Operating and storage temperature	T_j, T_{stg}	-55	-	150	°C	IEC climatic category; DIN IEC 68-1: 55/150/56

2 热特性

表 3 热特性

Parameter	Symbol	Values			Unit	Note / Test Condition
		Min.	Typ.	Max.		
Thermal resistance, junction - case, bottom	R_{thJC}	-	-	2.6	K/W	-
Thermal resistance, junction - case, top	R_{thJC}	-	-	20	K/W	-
Device on PCB, 6 cm ² cooling area ¹⁾	R_{thJA}	-	-	50	K/W	-

¹⁾器件位于 40 mm x 40 mm x 1.5 mm 环氧 FR4 PCB 上, 其中 6 cm² (单层, 70 μm 厚) 的铜面积用于漏极连接。PCB 垂直放置在静止空气中。

²⁾详细信息请参见图 3

³⁾详细信息请参见图 13

3 电气特性

表4 静态特性

Parameter	Symbol	Values			Unit	Note / Test Condition
		Min.	Typ.	Max.		
Drain-source breakdown voltage	$V_{(BR)DSS}$	30	-	-	V	$V_{GS}=0\text{ V}, I_D=10\text{ mA}$
Breakdown voltage temperature coefficient	$dV_{(BR)DSS}/dT_j$	-	15	-	mV/K	$I_D=10\text{ mA}$, referenced to 25 °C
Gate threshold voltage	$V_{GS(th)}$	1.2	-	2	V	$V_{DS}=V_{GS}, I_D=10\text{ mA}$
Zero gate voltage drain current	I_{DSS}	-	-	0.5	mA	$V_{DS}=24\text{ V}, V_{GS}=0\text{ V}$ $V_{DS}=24\text{ V}, V_{GS}=0\text{ V}, T_j=125\text{ °C}$
Gate-source leakage current	I_{GSS}	-	10	100	nA	$V_{GS}=20\text{ V}, V_{DS}=0\text{ V}$
Drain-source on-state resistance	$R_{DS(on)}$	-	3.0	3.7	mΩ	$V_{GS}=4.5\text{ V}, I_D=30\text{ A}$ $V_{GS}=10\text{ V}, I_D=30\text{ A}$
Gate resistance	R_G	0.5	0.9	1.8	Ω	-
Transconductance	g_{fs}	50	100	-	S	$ V_{DS} >2 I_D R_{DS(on)max}, I_D=30\text{ A}$

表5 动态特性

Parameter	Symbol	Values			Unit	Note / Test Condition
		Min.	Typ.	Max.		
Input capacitance	C_{iss}	-	1500	2000	pF	$V_{GS}=0\text{ V}, V_{DS}=15\text{ V}, f=1\text{ MHz}$
Output capacitance	C_{oss}	-	630	840	pF	$V_{GS}=0\text{ V}, V_{DS}=15\text{ V}, f=1\text{ MHz}$
Reverse transfer capacitance	C_{riss}	-	88	-	pF	$V_{GS}=0\text{ V}, V_{DS}=15\text{ V}, f=1\text{ MHz}$
Turn-on delay time	$t_{d(on)}$	-	3.9	-	ns	$V_{DD}=15\text{ V}, V_{GS}=10\text{ V}, I_D=30\text{ A}$, $R_{G,ext}=1.6\text{ Ω}$
Rise time	t_r	-	5.4	-	ns	$V_{DD}=15\text{ V}, V_{GS}=10\text{ V}, I_D=30\text{ A}$, $R_{G,ext}=1.6\text{ Ω}$
Turn-off delay time	$t_{d(off)}$	-	20	-	ns	$V_{DD}=15\text{ V}, V_{GS}=10\text{ V}, I_D=30\text{ A}$, $R_{G,ext}=1.6\text{ Ω}$
Fall time	t_f	-	3.8	-	ns	$V_{DD}=15\text{ V}, V_{GS}=10\text{ V}, I_D=30\text{ A}$, $R_{G,ext}=1.6\text{ Ω}$

表6 栅极电荷特性¹⁾

Parameter	Symbol	Values			Unit	Note / Test Condition
		Min.	Typ.	Max.		
Gate to source charge	Q_{gs}	-	4.0	-	nC	$V_{DD}=15\text{ V}, I_D=30\text{ A}, V_{GS}=0\text{ to }4.5\text{ V}$
Gate charge at threshold	$Q_{g(th)}$	-	2.4	-	nC	$V_{DD}=15\text{ V}, I_D=30\text{ A}, V_{GS}=0\text{ to }4.5\text{ V}$
Gate to drain charge	Q_{gd}	-	4.0	-	nC	$V_{DD}=15\text{ V}, I_D=30\text{ A}, V_{GS}=0\text{ to }4.5\text{ V}$
Switching charge	Q_{sw}	-	5.6	-	nC	$V_{DD}=15\text{ V}, I_D=30\text{ A}, V_{GS}=0\text{ to }4.5\text{ V}$
Gate charge total	Q_g	-	12.2	16.2	nC	$V_{DD}=15\text{ V}, I_D=30\text{ A}, V_{GS}=0\text{ to }4.5\text{ V}$
Gate plateau voltage	$V_{plateau}$	-	2.6	-	V	$V_{DD}=15\text{ V}, I_D=30\text{ A}, V_{GS}=0\text{ to }4.5\text{ V}$
Gate charge total	Q_g	-	24	32	nC	$V_{DD}=15\text{ V}, I_D=30\text{ A}, V_{GS}=0\text{ to }10\text{ V}$
Gate charge total, sync. FET	$Q_{g(sync)}$	-	9.8	-	nC	$V_{DS}=0.1\text{ V}, V_{GS}=0\text{ to }4.5\text{ V}$
Output charge	Q_{oss}	-	17	23	nC	$V_{DD}=15\text{ V}, V_{GS}=0\text{ V}$

¹⁾参数定义请参见“栅极充电波形”

表 7 反向二极管

Parameter	Symbol	Values			Unit	Note / Test Condition
		Min.	Typ.	Max.		
Diode continuous forward current	I_S	-	-	48	A	$T_C=25\text{ }^\circ\text{C}$
Diode pulse current	$I_{S,pulse}$	-	-	192	A	$T_C=25\text{ }^\circ\text{C}$
Diode forward voltage	V_{SD}	-	0.54	0.7	V	$V_{GS}=0\text{ V}, I_F=4\text{ A}, T_j=25\text{ }^\circ\text{C}$
Reverse recovery charge	Q_{rr}	-	5	-	nC	$V_R=15\text{ V}, I_F=4\text{ A}, di_F/dt=400\text{ A}/\mu\text{s}$

4 电气特性图

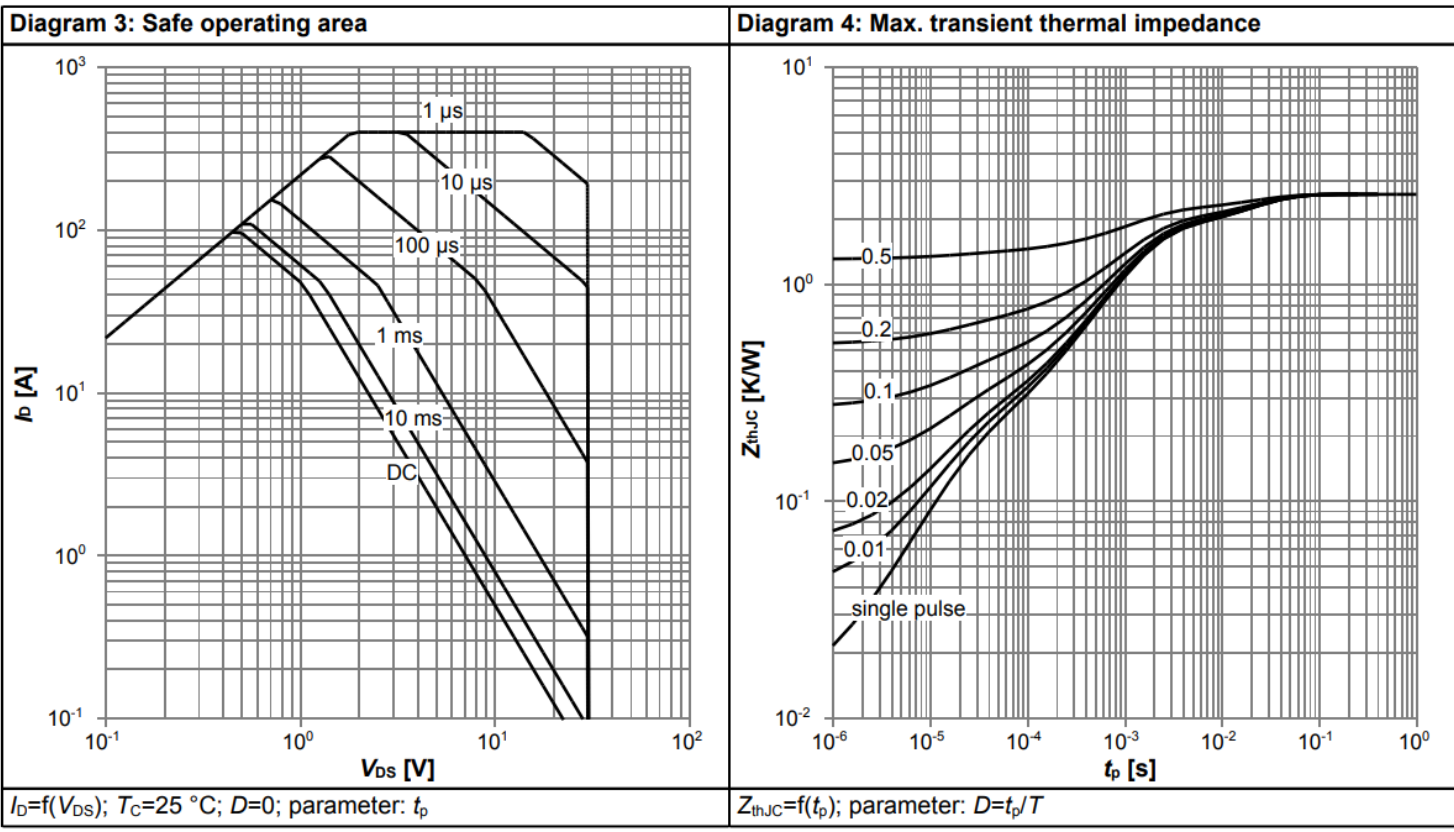
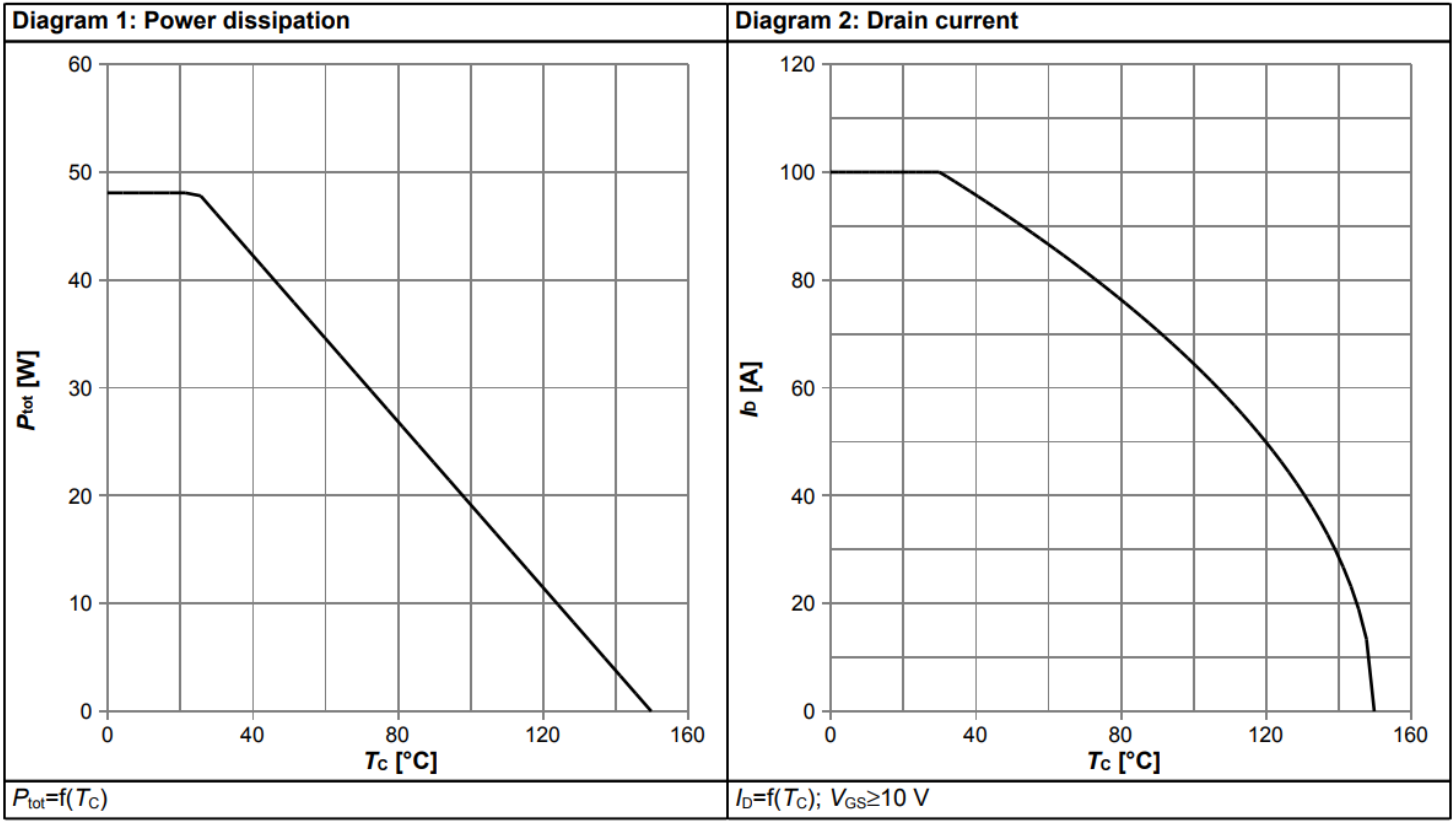
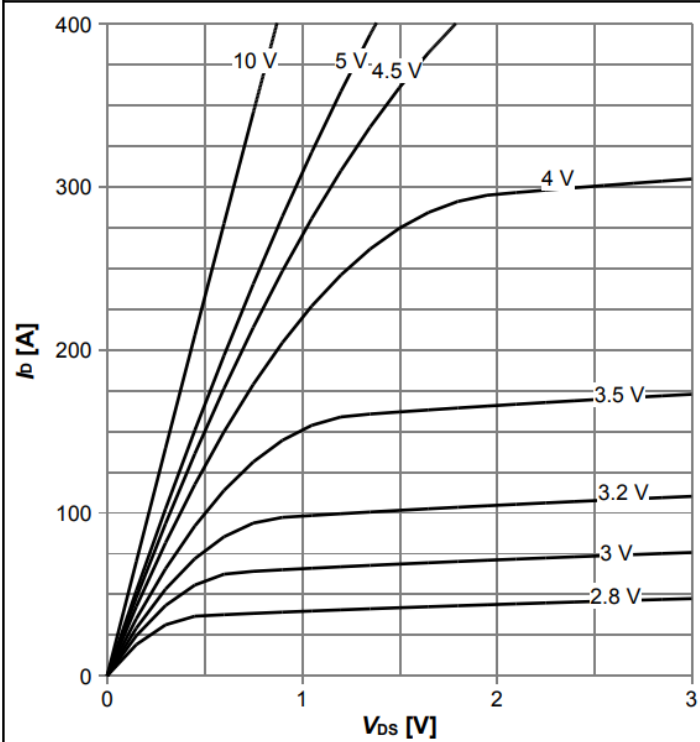

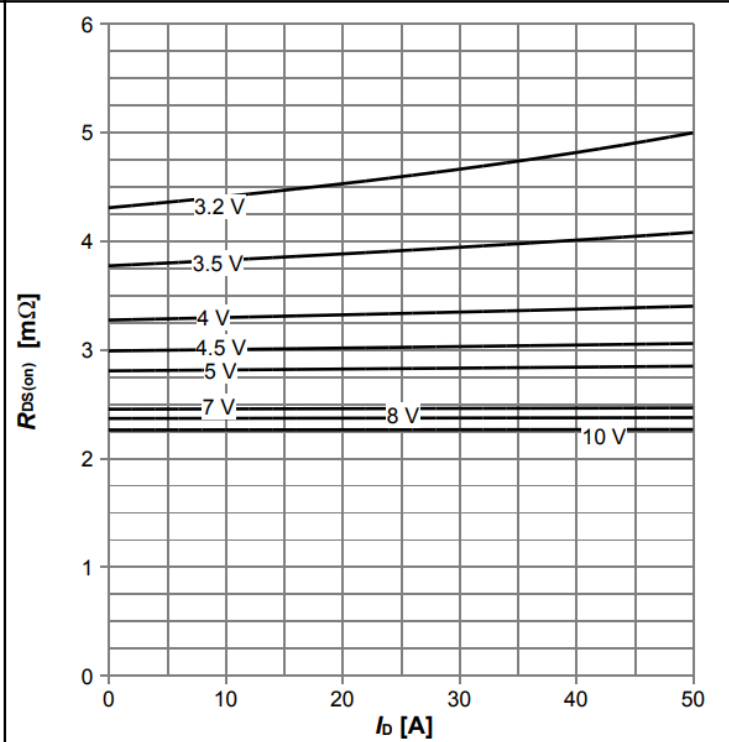

Diagram 5: Typ. output characteristics



$I_D = f(V_{DS}); T_J = 25\text{ °C};$ parameter: V_{GS}

Diagram 6: Typ. drain-source on resistance



$R_{DS(on)} = f(I_D); T_J = 25\text{ °C};$ parameter: V_{GS}

Diagram 7: Typ. transfer characteristics

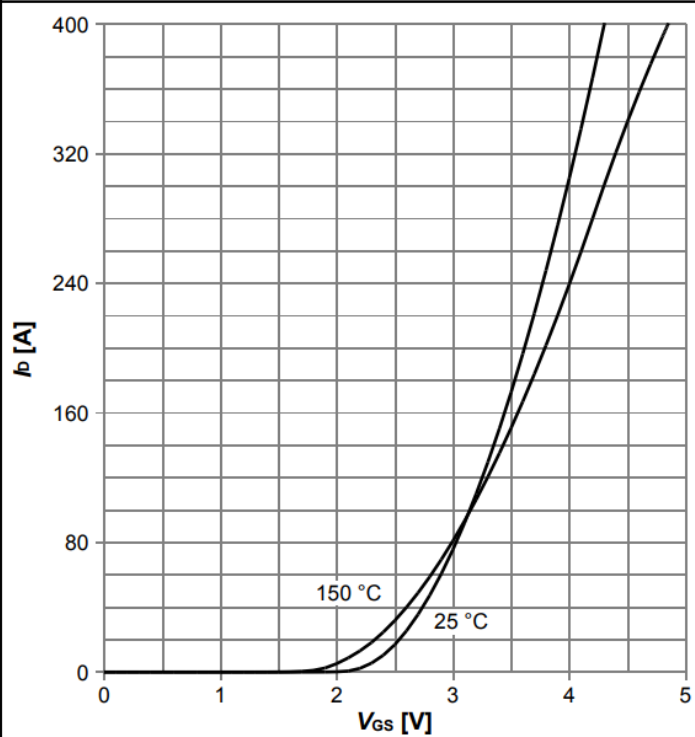

$I_D = f(V_{GS}); |V_{DS}| > 2|I_D|R_{DS(on)max};$ parameter: T_J

Diagram 8: Typ. forward transconductance

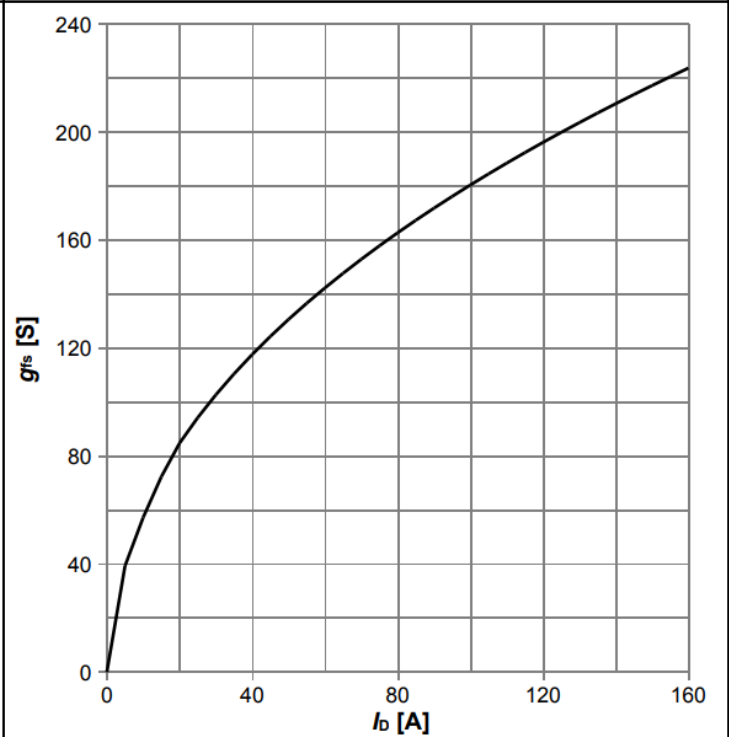

$g_{fs} = f(I_D); T_J = 25\text{ °C}$

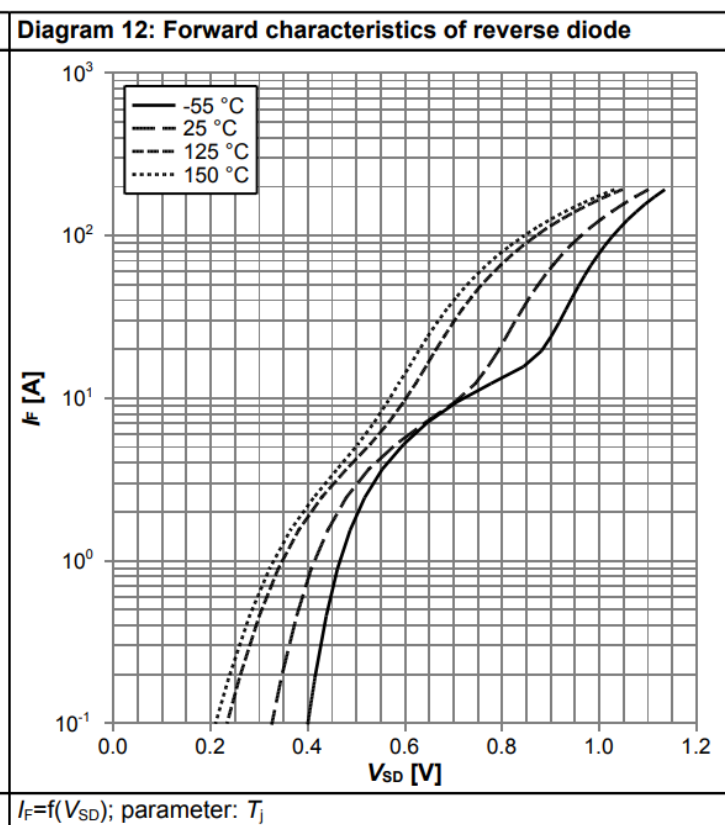
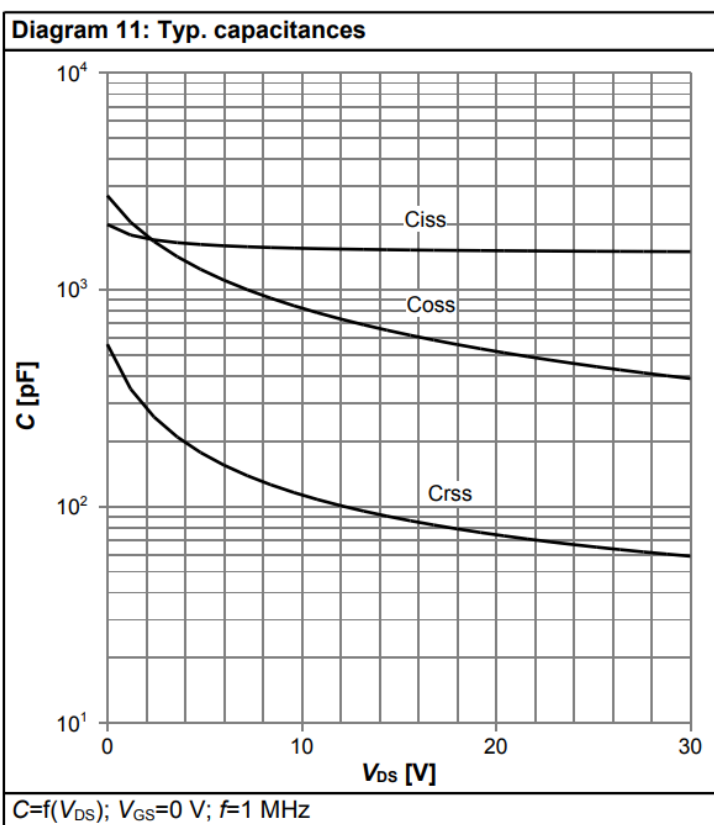
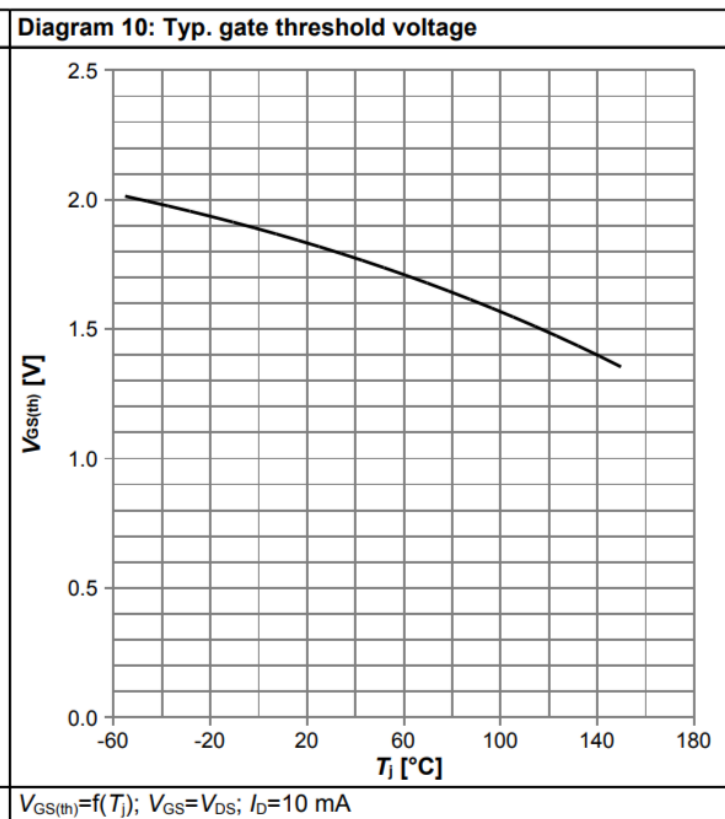
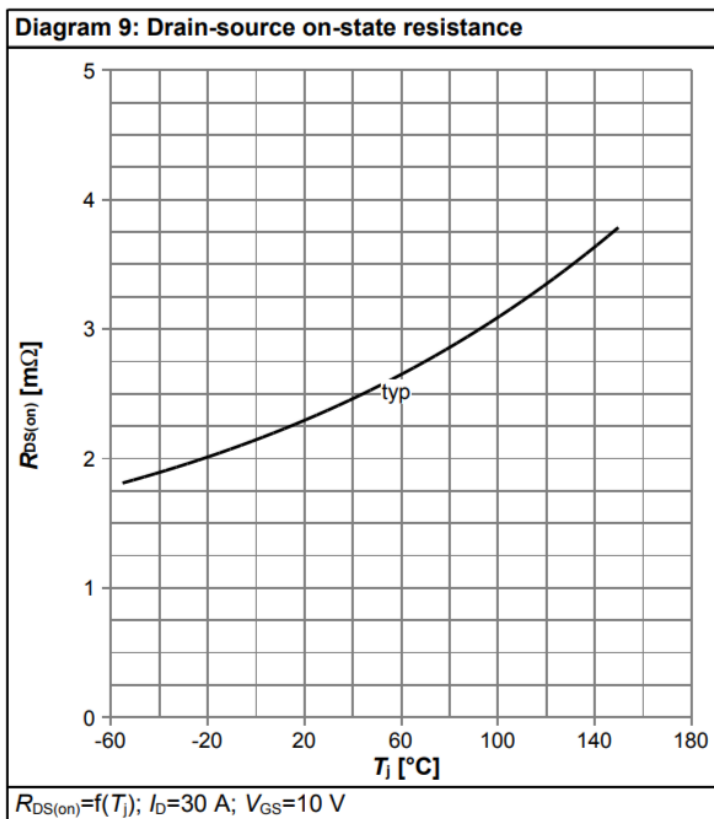

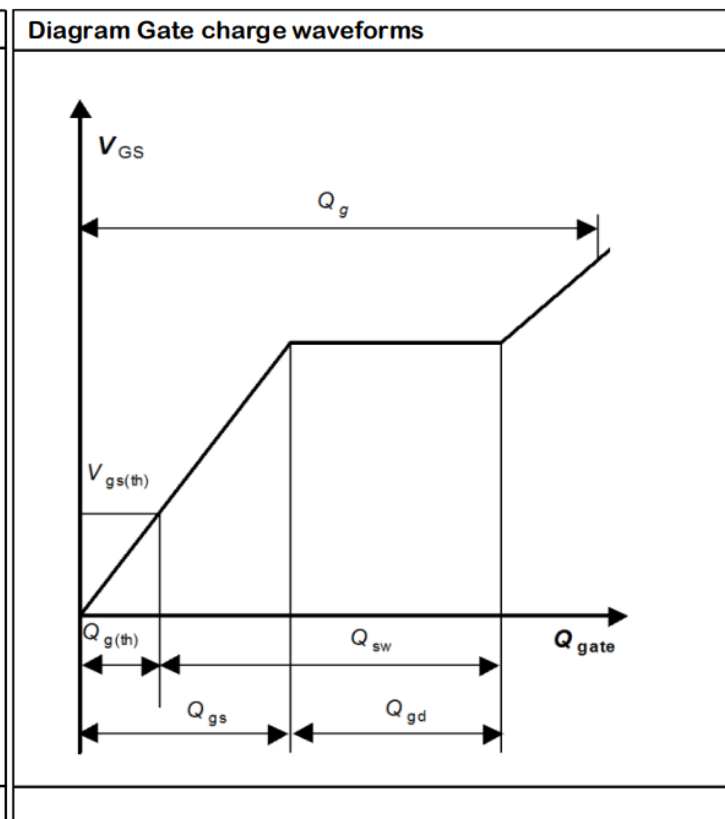
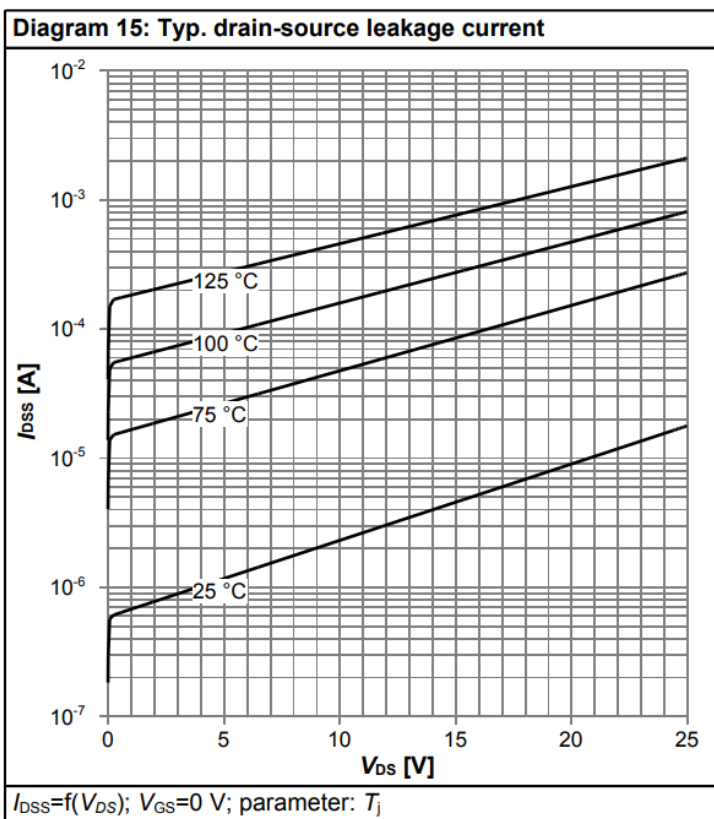
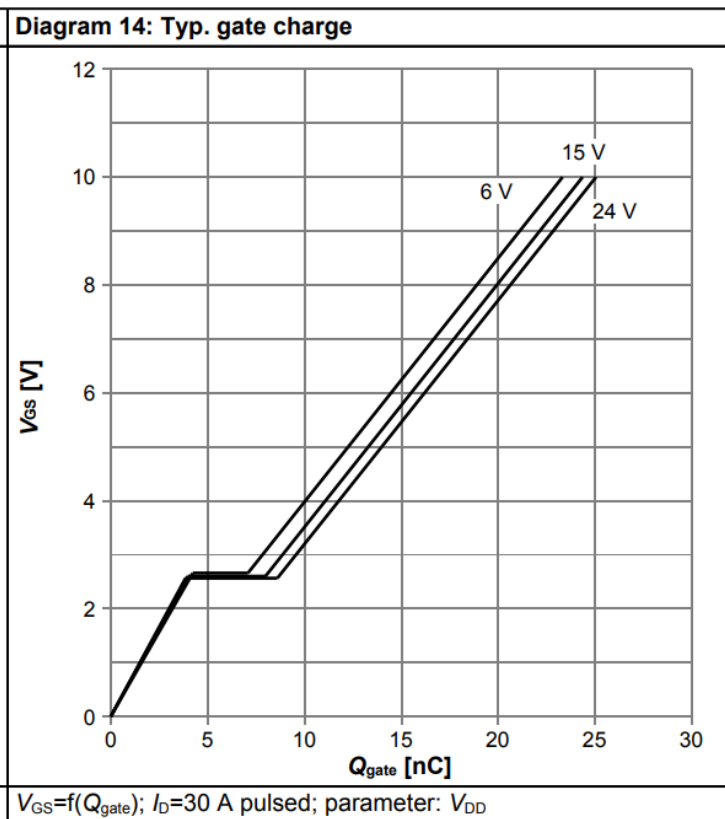
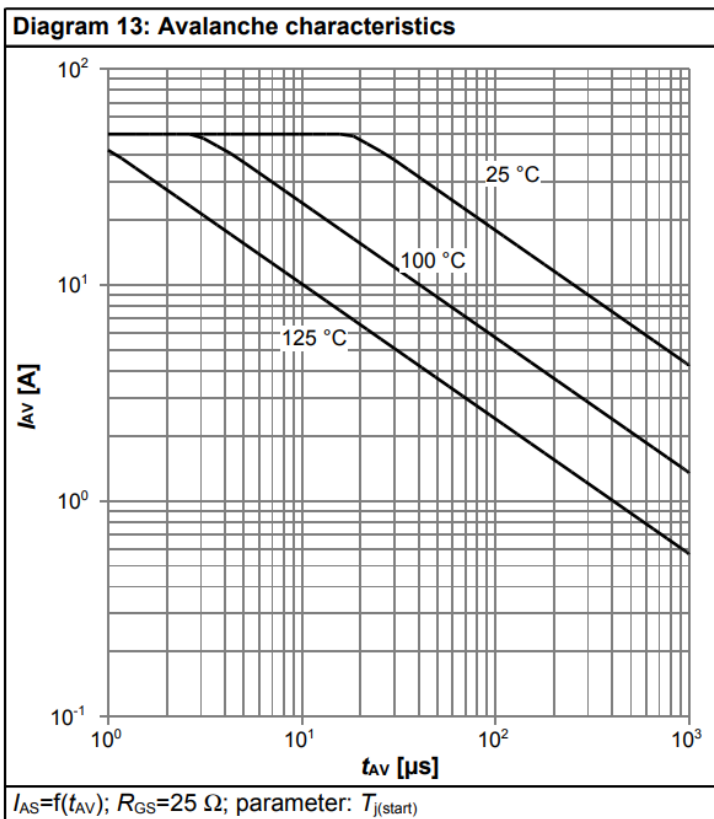

5 封装外形

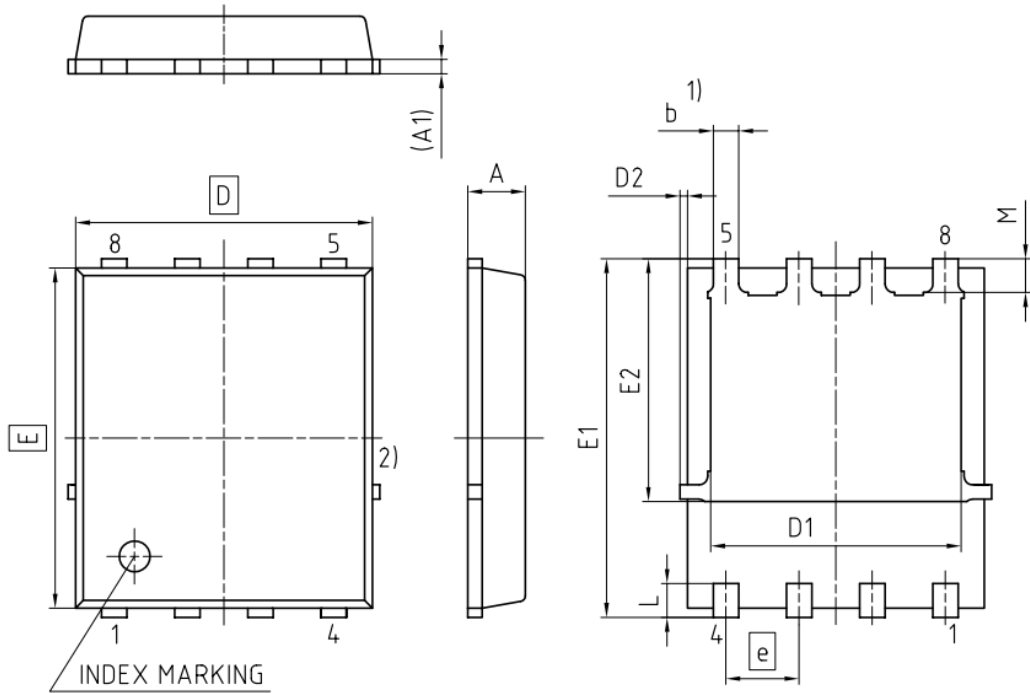

1) EXCLUDING MOLD FLASH
 2) REMOVAL ON MOLD GATE
 INTRUSION 0.1 MM
 PROTRUSION 0.1 MM
 LEAD LENGTH UP TO ANTI FLASH LINE
 ALL METAL SURFACES ARE PLATED, EXCEPT AREA OF CUT

DIMENSION	MILLIMETERS	
	MIN.	MAX.
A	0.90	1.20
A1	0.15	0.35
b	0.34	0.54
D	4.80	5.35
D1	3.90	4.40
D2	0.03	0.23
E	5.70	6.10
E1	5.90	6.42
E2	3.88	4.31
e	1.27	
L	0.45	0.71
M	0.45	0.69

DOCUMENT NO. Z8B00003332
REVISION 07
SCALE 10:1
EUROPEAN PROJECTION
ISSUE DATE 06.06.2019

图 1 PG-TDSON-8 外形图, 尺寸单位为毫米

PG-TDSON-8: Recommended Boardpads & Apertures



图 3 外形板焊盘 (TDSON-8), 尺寸单位为毫米

修订记录

BSC0902NSI

Revision: 2019-11-13, Rev. 2.4

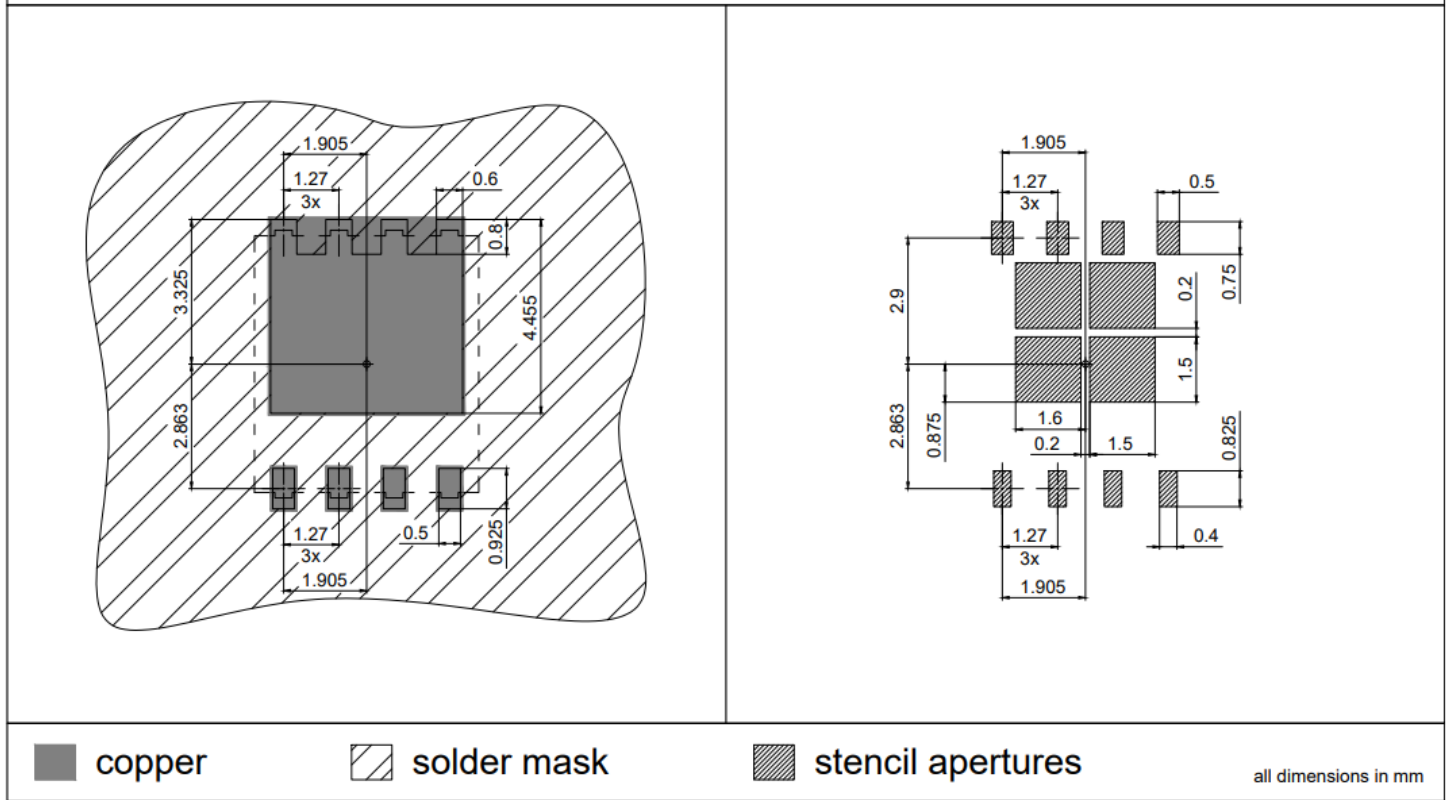
历史修订版本

Revision	Date	Subjects (major changes since last revision)
2.3	2016-02-03	Update Coss max
2.4	2019-11-13	Update package drawings

Trademarks

All referenced product or service names and trademarks are the property of their respective owners.

We Listen to Your Comments

Any information within this document that you feel is wrong, unclear or missing at all? Your feedback will help us to continuously improve the quality of this document. Please send your proposal (including a reference to this document) to: erratum@infineon.com

Published by

Infineon Technologies AG 81726
München, Germany
© 2019 Infineon Technologies AG
All Rights Reserved.

Legal Disclaimer

The information given in this document shall in no event be regarded as a guarantee of conditions or characteristics (“Beschaffenheitsgarantie”).

With respect to any examples, hints or any typical values stated herein and/or any information regarding the application of the product, Infineon Technologies hereby disclaims any and all warranties and liabilities of any kind, including without limitation warranties of non-infringement of intellectual property rights of any third party.

In addition, any information given in this document is subject to customer’s compliance with its obligations stated in this document and any applicable legal requirements, norms and standards concerning customer’s products and any use of the product of Infineon Technologies in customer’s applications.

The data contained in this document is exclusively intended for technically trained staff. It is the responsibility of customer’s technical departments to evaluate the suitability of the product for the intended application and the completeness of the product information given in this document with respect to such application.

Information

For further information on technology, delivery terms and conditions and prices please contact your nearest Infineon Technologies Office (www.infineon.com).

Warnings

Due to technical requirements, components may contain dangerous substances. For information on the types in question, please contact the nearest Infineon Technologies Office.

The Infineon Technologies component described in this Data Sheet may be used in life-support devices or systems and/or automotive, aviation and aerospace applications or systems only with the express written approval of Infineon Technologies, if a failure of such components can reasonably be expected to cause the failure of that life-support, automotive, aviation and aerospace device or system or to affect the safety or effectiveness of that device or system. Life support devices or systems are intended to be implanted in the human body or to support and/or maintain and sustain and/or protect human life. If they fail, it is reasonable to assume that the health of the user or other persons may be endangered.



免责声明

请注意，本文件的原文使用英文撰写，为方便客户浏览英飞凌提供了中文译文。该中文译文仅供参考，并不可作为任何论点之依据。

由于翻译过程中可能使用了自动化程序，以及语言翻译和转换过程中的差异，最后的中文译文与最新的英文版本原文含义可能存在不尽相同之处。

因此，我们同时提供该中文译文版本的最新英文原文供您阅读，请参见 <http://www.infineon.com>

英文原文和中文译文版本之间若存有任何歧异，以最新的英文版本为准，并且仅认可英文版本为正式文件。

您如果使用本文件，即表示您同意并理解上述说明。英飞凌不对因翻译过程中可能存在的任何不完整或不准确信息而产生的任何直接或间接损失或损害负责。英飞凌不承担中文译文版本的完整性和准确性责任。如果您不同意上述说明，请不要使用本文件。

Trademarks

All referenced product or service names and trademarks are the property of their respective owners.

重要通知

版本 2025-12-24

Infineon Technologies AG 出版，
德国 Neubiberg 85579

版权 © 2025 Infineon Technologies AG
及其关联公司。
保留所有权利。

Do you have a question about this
document?

Email:

erratum@infineon.com

Infineon Technologies AG 及其关联公司（以下简称“英飞凌”）销售或提供和交付的产品（可能也包括样品，且可能由硬件或软件或两者组成）（以下简称“产品”），应遵守客户与英飞凌签订的框架供应合同或其他书面协议的条款和条件，如无上合同或其他书面协议，则应遵守适用的英飞凌销售条件。只有在英飞凌明确书面同意的情况下，客户的一般条款和条件或对适用的英飞凌销售条件的偏离才对英飞凌具有约束力。

为避免疑义，英飞凌不承担不侵犯第三方权利的所有保证和默示保证，例如对特定用途/目的的适用性或适销性的保证。

英飞凌对与样品、应用或客户对任何产品的具体使用有关的任何信息或本文件中给出的任何示例或典型值概不负责。

本文件中包含的数据仅供具有技术资格和技能的客户代表使用。客户有责任评估产品对预期应用和客户特定用途的适用性，并在预期应用和客户特定用途中验证本文件中包含的所有相关技术数据。客户有责任正确设计、编程和测试预期应用的功能性和安全性，并遵守与其使用相关的法律要求。

除非英飞凌另行明确批准，否则产品不得用于任何因产品故障或使用产品的任何后果可合理预期会导致人身伤害的应用。但是，上述规定并不妨碍客户在英飞凌明确设计和销售的使用领域中使用任何产品，但是客户对应用负有全部责任。

英飞凌明确保留根据适用法律，如《德国版权法》（UrhG）第 44b 条，将其内容用于商业资料和数据探勘（TDM）的权利。

如果产品包含安全功能：

由于任何计算设备都不可能绝对安全，尽管产品采取了安全措施，但英飞凌不保证产品不会被入侵、数据不会被盗或遗失，或不会发生其他漏洞（以下简称“安全漏洞”），英飞凌对任何安全漏洞不承担任何责任。

如果本文件包含或引用软件：

根据美国、德国和世界其他国家的知识产权法律和条约，该软件归英飞凌所有。英飞凌保留所有权利。因此，您只能按照软件附带的软件授权协议的规定使用本软件。

如果没有适用的软件授权协议，英飞凌特此授予您个人的、非排他性的、不可转让的软件知识产权授权（无权转授权）：(a) 对于以源代码形式提供的软件，仅在贵组织内部修改和复制该软件用于英飞凌硬件产品；及 (b) 对于以二进制代码 (binary code) 形式对外向终端用户分发该软件，仅得用于英飞凌硬件产品。禁止对本软件进行任何其他使用、复制、修改、翻译或编译。有关产品、技术、交货条款和条件以及价格的详细信息，请联系离您最近的英飞凌办公室或访问 <https://www.infineon.com>。