

OptiMOS™ -5 Power Transistor

Features

- OptiMOS™ power MOSFET for automotive applications
- N-channel - Enhancement mode - Normal Level
- MSL1 up to 260°C peak reflow
- 175 °C operating temperature
- Green product (RoHS compliant)
- 100% Avalanche tested

Product Summary

V_{DS}	80	V
$R_{DS(on),max}$	10.2	mΩ
I_D	50	A

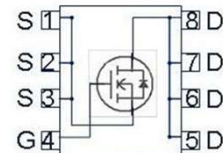
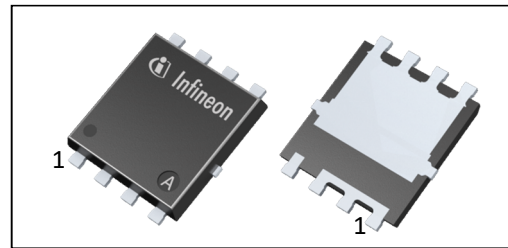
PG-TDSON-8-33

Type	Package	Marking
IAUC50N08S5N102	PG-TDSON-8-33	5N08102

Maximum ratings, at $T_j=25\text{ °C}$, unless otherwise specified

Parameter	Symbol	Conditions	Value	Unit
Drain current	I_D	$V_{GS}=10\text{ V}$, Chip limitation ^{1,2)}	50	A
		$V_{GS}=10\text{ V}$, DC current	50	
		$T_a=85\text{ °C}$, $V_{GS}=10\text{ V}$, R_{thJA} on 2s2p ^{2,3)}	12	
Pulsed drain current ²⁾	$I_{D,pulse}$	$T_C=25\text{ °C}$	200	
Avalanche energy, single pulse ²⁾	E_{AS}	$I_D=29\text{ A}$	45	mJ
Avalanche current, single pulse	I_{AS}	-	29	A
Gate source voltage	V_{GS}	-	±20	V
Power dissipation	P_{tot}	$T_C=25\text{ °C}$	60	W
Operating and storage temperature	T_j, T_{stg}	-	-55 ... +175	°C

Parameter	Symbol	Conditions	Values			Unit
			min.	typ.	max.	

Thermal characteristics²⁾

Thermal resistance, junction - case	R_{thJC}	-	-	-	2.5	K/W
Thermal resistance, junction - ambient ⁴⁾	R_{thJA}	-	-	24.9	-	

Electrical characteristics, at $T_j=25^\circ\text{C}$, unless otherwise specified
Static characteristics

Drain-source breakdown voltage	$V_{(BR)DSS}$	$V_{GS}=0V, I_D=1mA$	80	-	-	V
Gate threshold voltage	$V_{GS(th)}$	$V_{DS}=V_{GS}, I_D=24\mu A$	2.2	3.0	3.8	
Zero gate voltage drain current	I_{DSS}	$V_{DS}=80V, V_{GS}=0V, T_j=25^\circ\text{C}$	-	0.1	1	μA
		$V_{DS}=80V, V_{GS}=0V, T_j=85^\circ\text{C}^{2)}$	-	1	20	
Gate-source leakage current	I_{GSS}	$V_{GS}=20V, V_{DS}=0V$	-	-	100	nA
Drain-source on-state resistance	$R_{DS(on)}$	$V_{GS}=6V, I_D=12.5A$	-	12.3	15.8	m Ω
		$V_{GS}=10V, I_D=25A$	-	8.4	10.2	
Gate resistance ²⁾	R_G	-	-	1.1	-	Ω

Parameter	Symbol	Conditions	Values			Unit
			min.	typ.	max.	

Dynamic characteristics²⁾

Input capacitance	C_{iss}	$V_{GS}=0V, V_{DS}=40V,$ $f=1MHz$	-	1072	1394	pF
Output capacitance	C_{oss}		-	204	265	
Reverse transfer capacitance	C_{rss}		-	13	20	
Turn-on delay time	$t_{d(on)}$	$V_{DD}=40V, V_{GS}=10V,$ $I_D=25A, R_{G,ext}=3.5\Omega$	-	4	-	ns
Turn-off delay time	$t_{d(off)}$		-	6	-	
Rise time	t_r		-	2	-	
Fall time	t_f		-	4	-	

Gate Charge Characteristics²⁾

Gate to source charge	Q_{gs}	$V_{DD}=40V, I_D=25A,$ $V_{GS}=0 \text{ to } 10V$	-	5	7	nC
Gate to drain charge	Q_{gd}		-	4	6	
Gate charge total	Q_g		-	16	21	
Gate plateau voltage	$V_{plateau}$		-	5.0	-	V

Reverse Diode

Diode continuous forward current ²⁾	I_S	$T_C=25^\circ C$	-	-	50	A
Diode pulse current ²⁾	$I_{S,pulse}$	$T_C=25^\circ C$	-	-	200	
Diode forward voltage	V_{SD}	$V_{GS}=0V, I_F=25A,$ $T_j=25^\circ C$	-	0.9	1.2	V
Reverse recovery time ²⁾	t_{rr}	$V_R=40V, I_F=50A,$ $di_F/dt=100A/\mu s$	-	32	-	ns
Reverse recovery charge ²⁾	Q_{rr}		-	25	-	nC

¹⁾ Practically the current is limited by the overall system design including the customer-specific PCB.

²⁾ The parameter is not subject to production test - verified by design/characterization.

³⁾ Device on a four-layer 2s2p FR4 PCB defined in accordance with JEDEC standards (JESD51-5-7). PCB is vertical in still air.

1 Power dissipation

$P_{tot} = f(T_C); V_{GS} = 10\text{ V}$

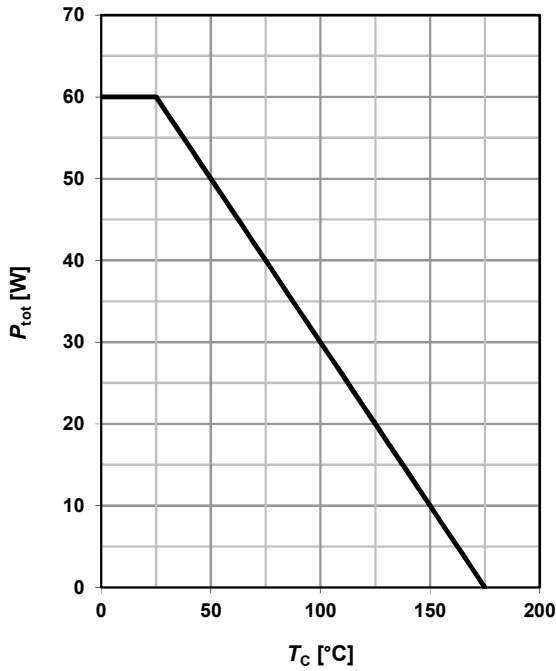

2 Drain current

$I_D = f(T_C); V_{GS} = 10\text{ V}$

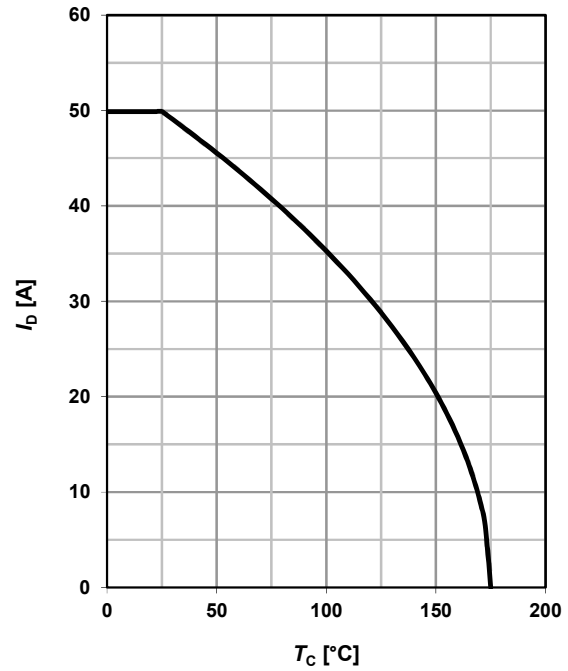

3 Safe operating area

$I_D = f(V_{DS}); T_C = 25\text{ °C}; D = 0$

parameter: t_p

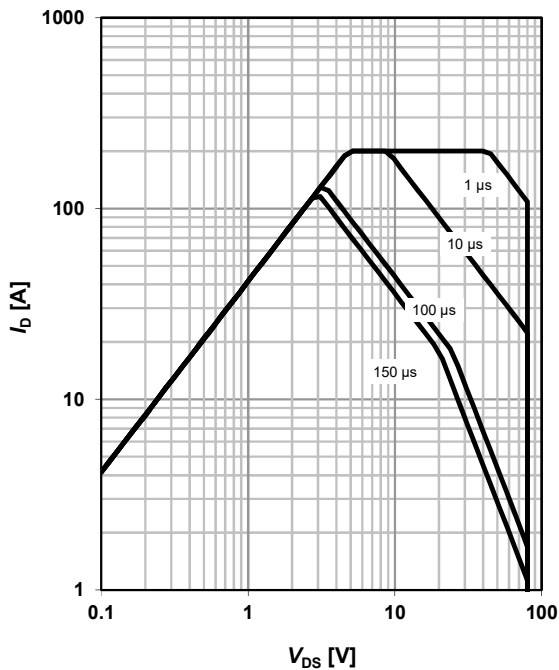

4 Max. transient thermal impedance

$Z_{thJC} = f(t_p)$

parameter: $D = t_p/T$

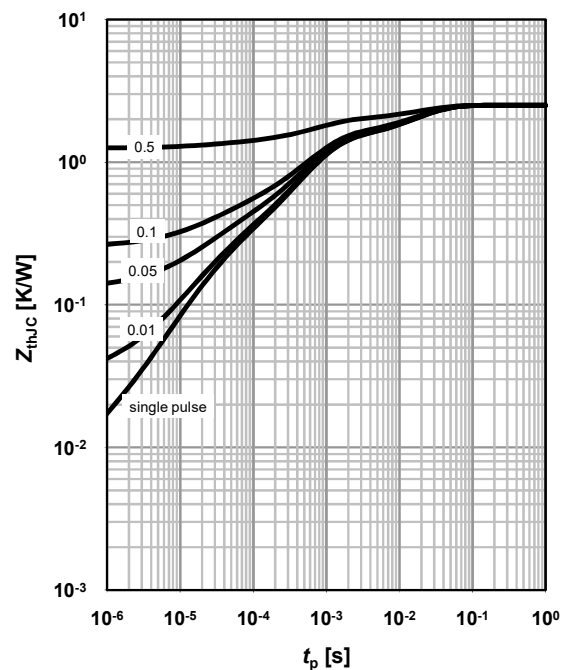

5 Typ. output characteristics

$$I_D = f(V_{DS}); T_j = 25\text{ }^\circ\text{C}$$

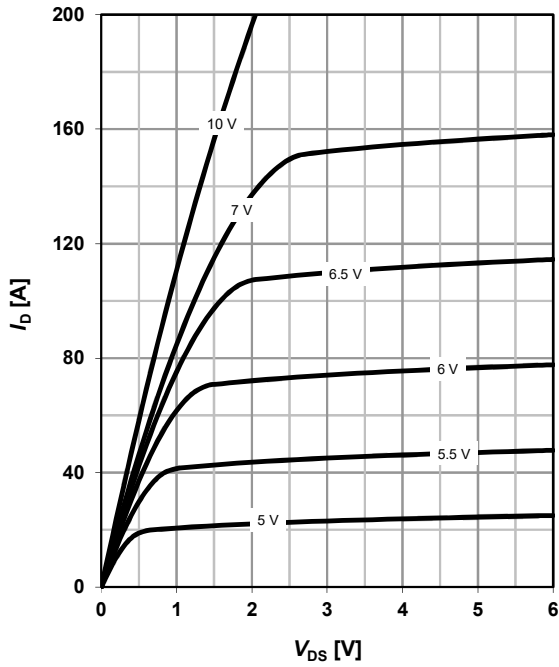
 parameter: V_{GS}

6 Typ. drain-source on-state resistance

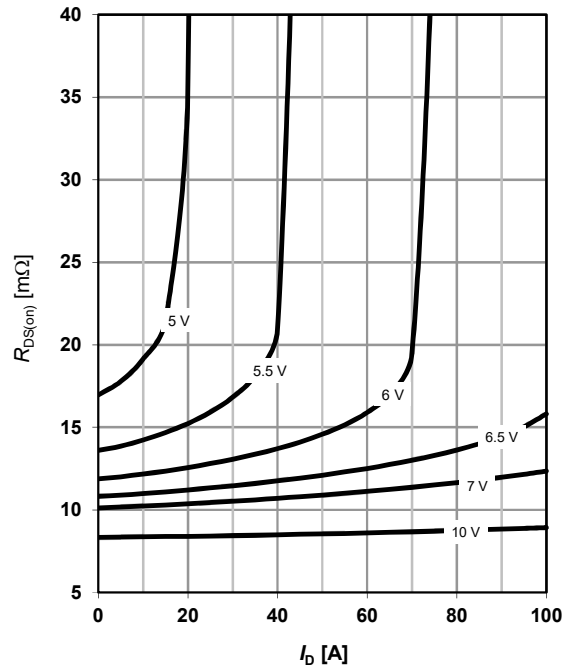
$$R_{DS(on)} = f(I_D); T_j = 25\text{ }^\circ\text{C}$$

 parameter: V_{GS}

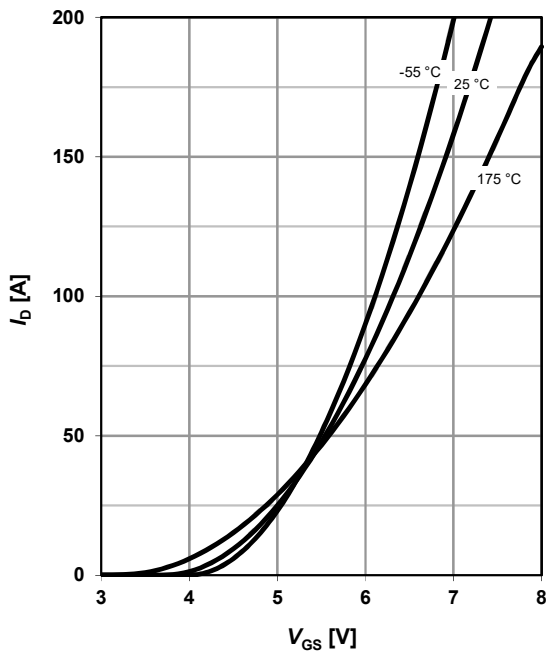
7 Typ. transfer characteristics

$$I_D = f(V_{GS}); V_{DS} = 6\text{ V}$$

 parameter: T_j

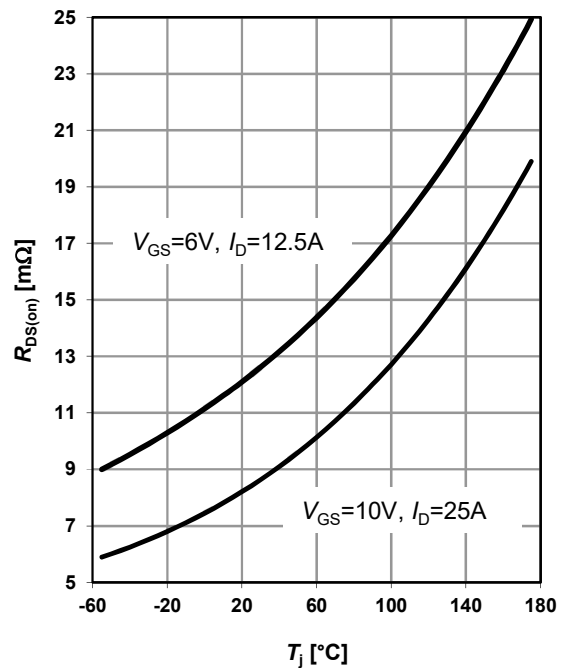
8 Typ. drain-source on-state resistance

$$R_{DS(on)} = f(T_j);$$

 parameter: I_D, V_{GS}

9 Typ. gate threshold voltage

$$V_{GS(th)} = f(T_j); V_{GS} = V_{DS}$$

parameter: I_D

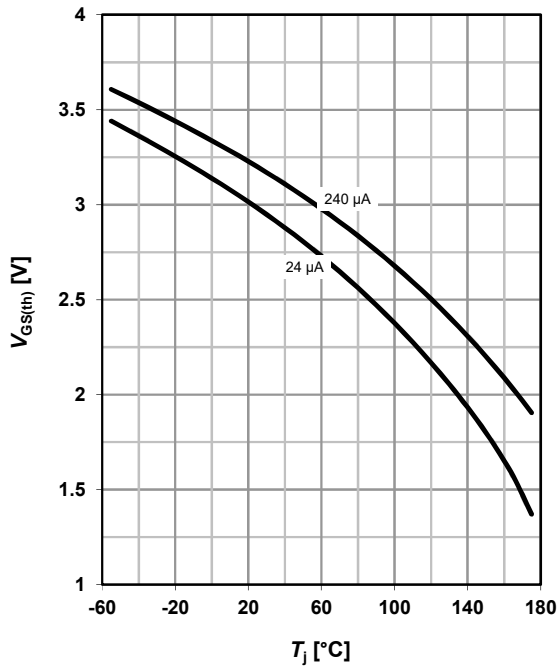

10 Typ. capacitances

$$C = f(V_{DS}); V_{GS} = 0 V; f = 1 MHz$$

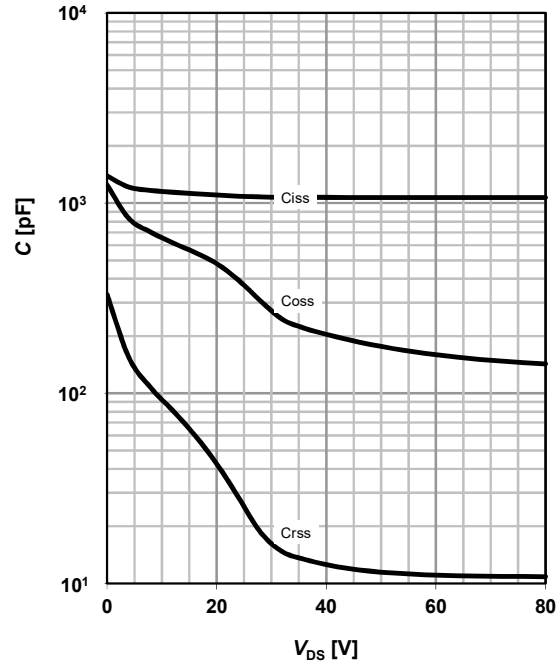

11 Typical forward diode characteristics

$$I_F = f(V_{SD})$$

parameter: T_j

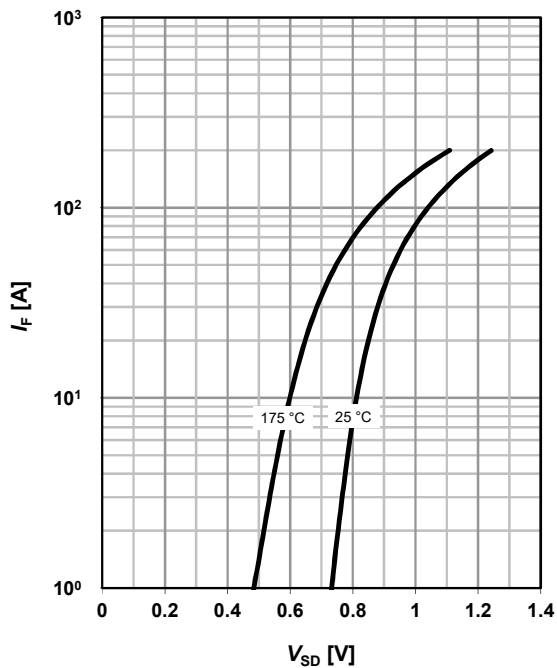

12 Avalanche characteristics

$$I_{AS} = f(t_{AV})$$

parameter: $T_{j(start)}$

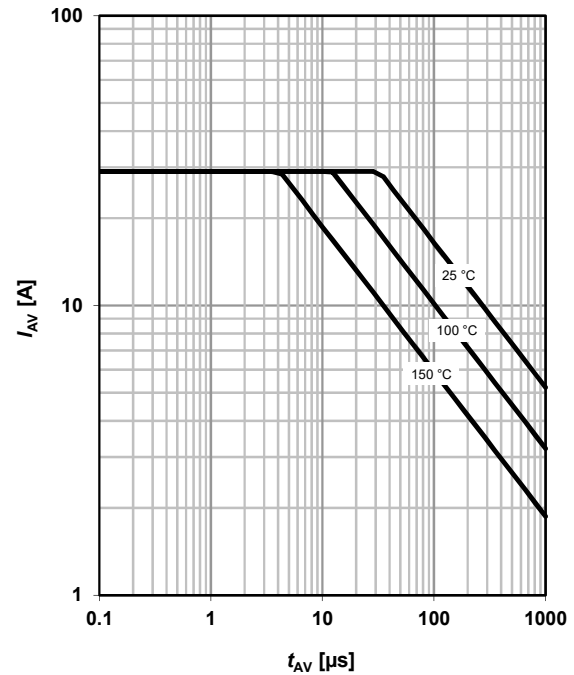

13 Avalanche energy

$$E_{AS} = f(T_j)$$

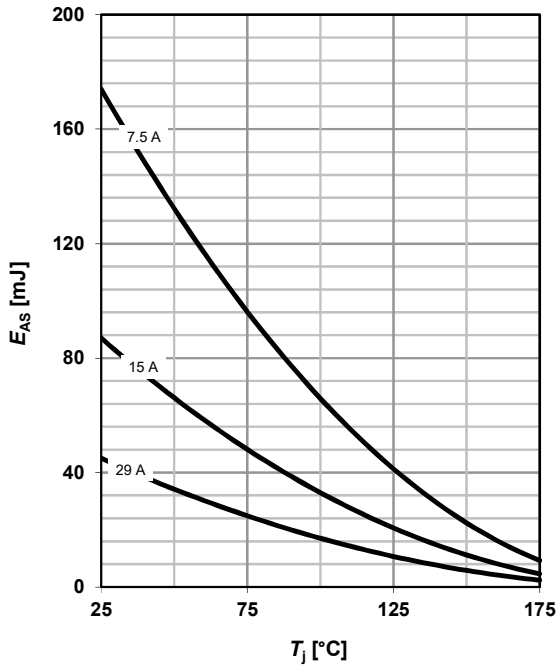
 parameter: I_D

14 Drain-source breakdown voltage

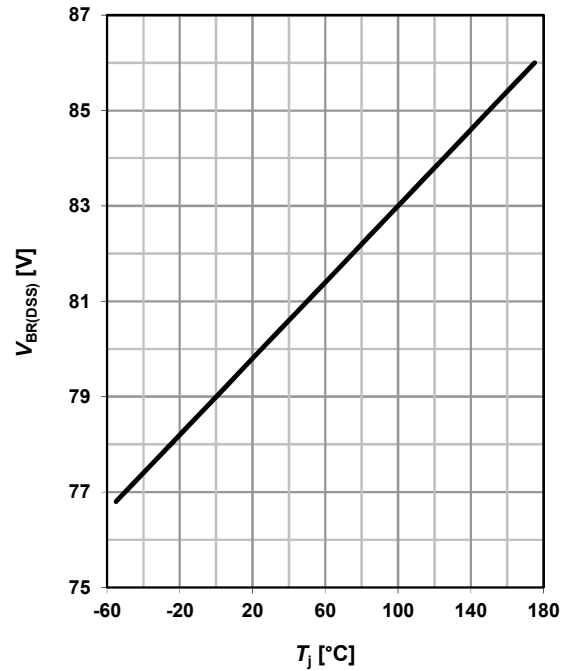
$$V_{BR(DSS)} = f(T_j); I_D = 1 \text{ mA}$$

15 Typ. gate charge

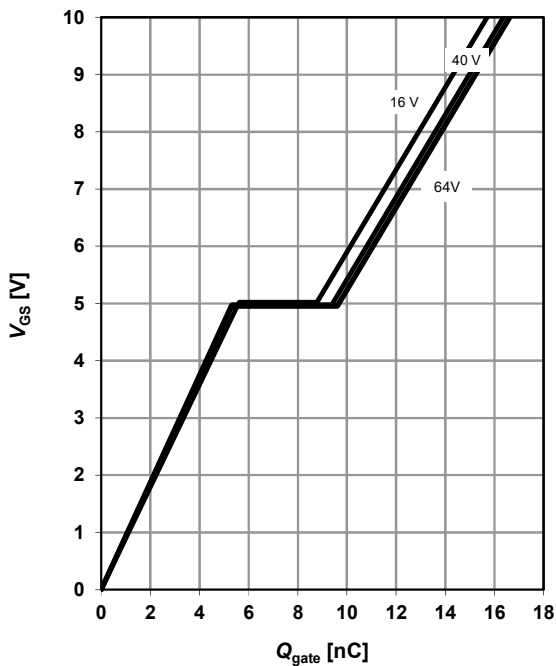
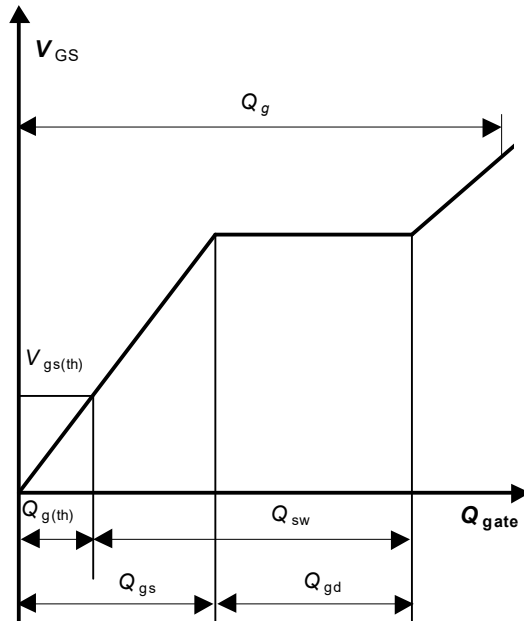
$$V_{GS} = f(Q_{gate}); I_D = 25 \text{ A pulsed}$$

 parameter: V_{DD}

16 Gate charge waveforms

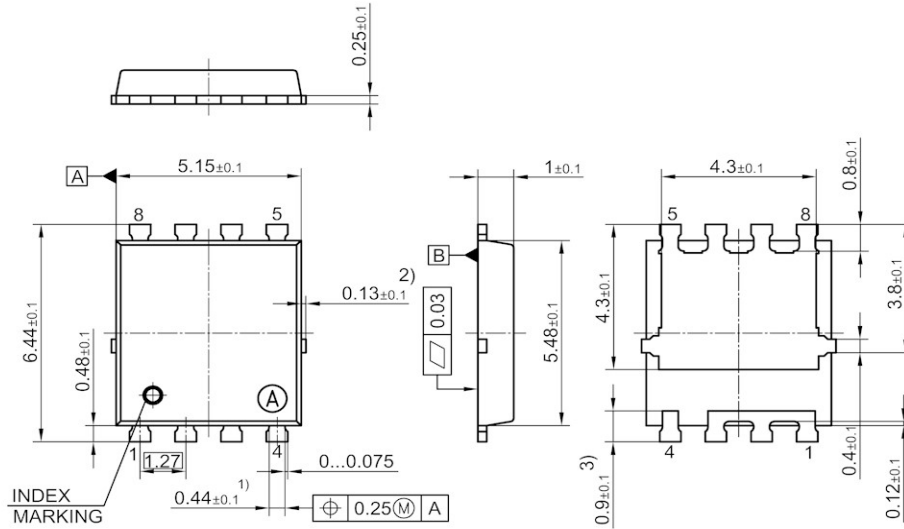
Package Outline

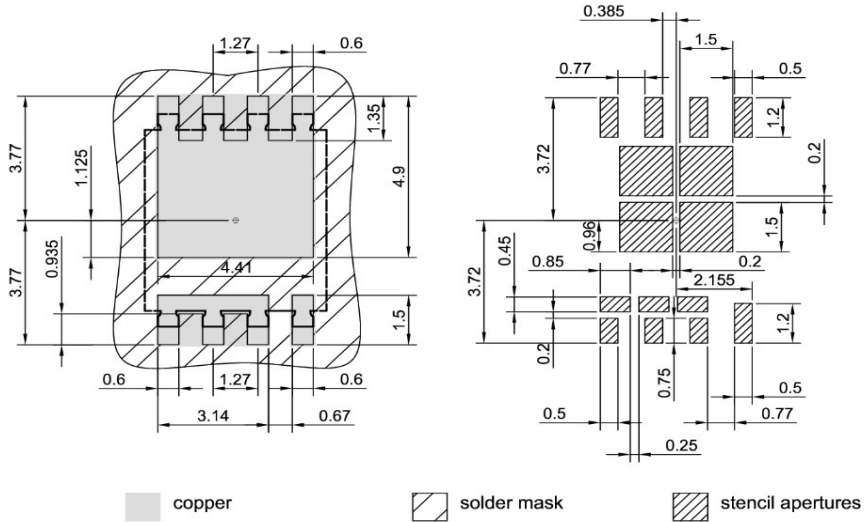

- 1) EXCLUDE MOLD FLASH
 - 2) REMOVAL ON MOLD GATE, INTRUSION 0.1MM AND PROTRUSION 0.1MM
 - 3) LEAD LENGTH UP TO ANTI FLASH LINE
 - 4) ALL METAL SURFACE ARE PLATED, EXCEPT AREA OF CUT
- ALL DIMENSIONS ARE IN UNITS MM
 THE DRAWING IS IN COMPLIANCE WITH ISO 128 & PROJECTION METHOD 1 []

Footprint



All dimensions are in units mm

Packaging

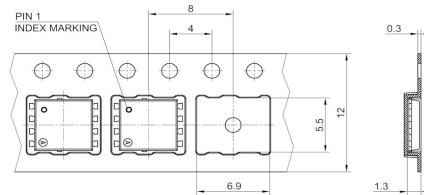

ALL DIMENSIONS ARE IN UNITS MM
 THE DRAWING IS IN COMPLIANCE WITH ISO 128 & PROJECTION METHOD 1 []

Published by
Infineon Technologies AG
81726 Munich, Germany

© Infineon Technologies AG 2021
All Rights Reserved.

Legal Disclaimer

The information given in this document shall in no event be regarded as a guarantee of conditions or characteristics. With respect to any examples or hints given herein, any typical values stated herein and/or any information regarding the application of the device, Infineon Technologies hereby disclaims any and all warranties and liabilities of any kind, including without limitation, warranties of non-infringement of intellectual property rights of any third party.

Information

For further information on technology, delivery terms and conditions and prices, please contact the nearest Infineon Technologies Office (www.infineon.com).

Warnings

Due to technical requirements, components may contain dangerous substances.
For information on the types in question, please contact the nearest Infineon Technologies Office. Infineon Technologies components may be used in life-support devices or systems only with the express written approval of Infineon Technologies, if a failure of such components can reasonably be expected to cause the failure of that life-support device or system or to affect the safety or effectiveness of that device or system. Life support devices or systems are intended to be implanted in the human body or to support and/or maintain and sustain and/or protect human life. If they fail, it is reasonable to assume that the health of the user or other persons may be endangered.

Revision History

Version	Date	Changes
Revision 1.0	2021-05-14	Final Data Sheet
Revision 1.1	2021-06-18	Datasheet file name updated