

PSoC™ 6 MCU dual-core system design

About this document

Scope and purpose

AN215656 describes the dual-core architecture in PSoC™ 6 MCUs, which includes Arm® Cortex®-M4 and Cortex®-M0+ cores, as well as an inter-processor communication (IPC) module. A dual-core architecture provides the flexibility to help improve system performance and efficiency and reduce power consumption. The application note also shows how to build a simple dual-core design using ModusToolbox™ software, Command-line Interface (CLI), and PSoC™ Creator IDE, and how to debug the design using various IDEs.

To access an ever-growing list of hundreds of PSoC™ code examples, please visit our [code examples web page](#). You can also explore the Infineon video training library [here](#).

Intended audience

This application note is intended for advanced engineers who want to use the full dual-core capabilities of the PSoC™ 6 MCU.

Table of contents

	About this document	1
	Table of contents	1
1	Introduction	3
1.1	Tools and libraries	5
1.2	How to use this document	6
2	General dual-core concepts	7
3	PSoC™ 6 MCU dual-core architecture	8
4	PSoC™ 6 MCU dual-core development	10
4.1	ModusToolbox™ software instructions	10
4.1.1	Creating a dual-core application	10
4.1.1.1	Eclipse IDE for ModusToolbox™	10
4.1.1.2	Command-line Interface (CLI)	11
4.1.1.3	Modify application contents	12
4.1.1.4	Build and program	13
4.1.2	Customizing linker scripts	14
4.1.3	Sharing libraries and peripherals	14
4.2	PSoC™ Creator instructions	16
4.3	Resource assignment considerations	19
4.4	Power mode transition considerations	19
4.5	IPC configuration considerations	20
4.6	Interrupt assignment considerations	20
4.7	Debug considerations	21
4.7.1	ModusToolbox™ instructions	22
4.7.2	PSoC™ Creator instructions	22
4.7.3	Instructions for other IDEs	22



Table of contents

4.7.3.1 Exporting ModusToolbox™ applications to supported IDEs22

4.7.3.2 Exporting from PSoC™ Creator23

4.8 Connectivity application design considerations 40

4.8.1 Throughput analysis40

4.8.2 Power consumption analysis 43

4.8.3 Porting applications between cores 46

4.8.4 Virtual Connectivity Manager 46

5 Summary 47

References48

Revision history50

Trademarks51

Disclaimer 52

1 Introduction

1 Introduction

PSoC™ 6 MCU is 32-bit ultra-low-power PSoC™, purpose-built for the Internet of Things (IoT). It integrates low-power flash and SRAM technology, programmable digital logic, programmable analog, high-performance analog-digital conversion, low-power comparators, and standard communication and timing peripherals.

Of particular interest in PSoC™ 6 MCU is the CPU subsystem. The architecture incorporates multiple bus masters – two CPUs, DMA Controllers, and a cryptography block (Crypto) – as [Figure 1](#) shows:

1 Introduction

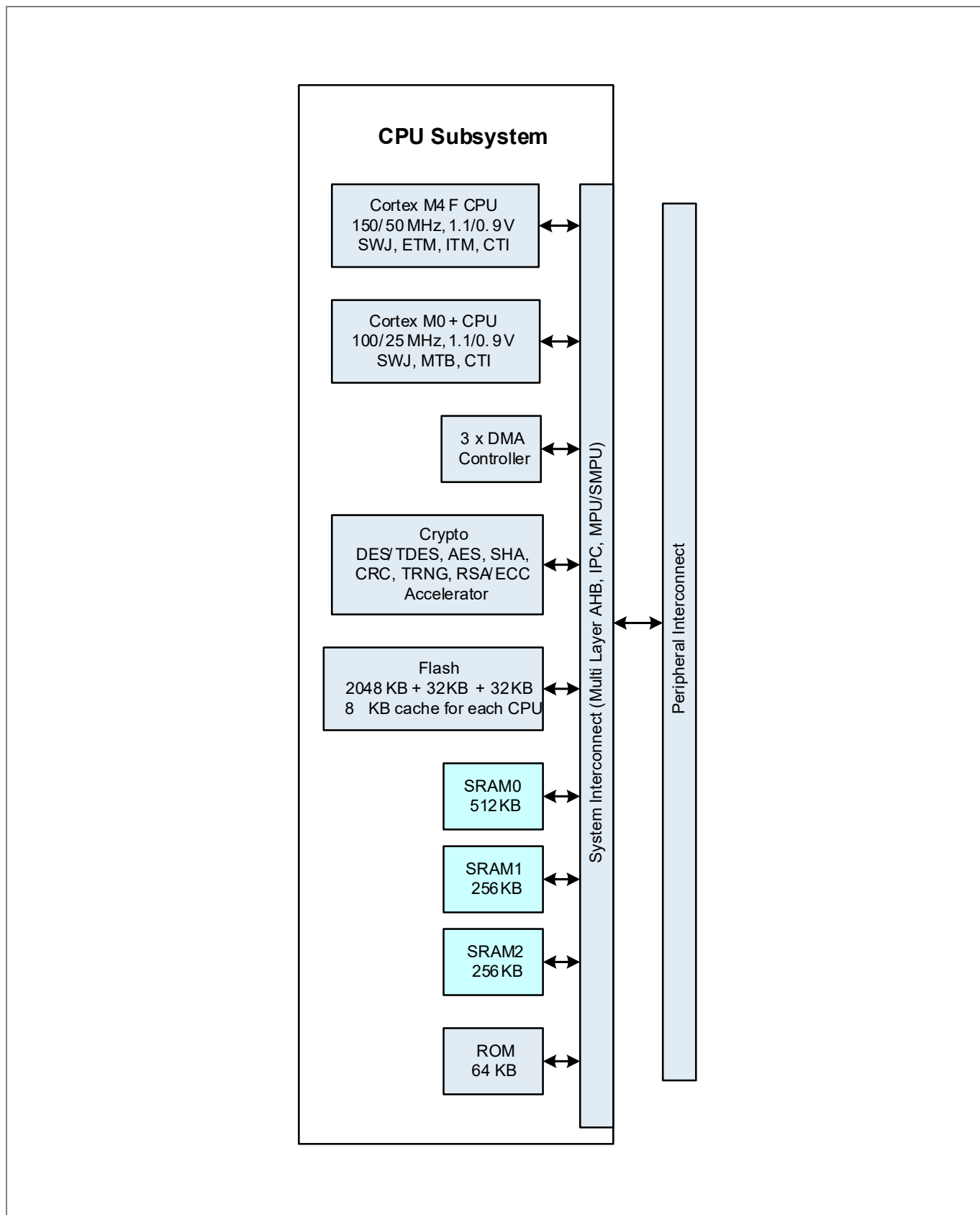

Figure 1 PSoc™ 6 MCU typical CPU subsystem architecture

1 Introduction

Note: The contents of the block diagram in [Figure 1](#) may vary depending on the device. Some PSoC™ 6 MCU parts have only one CPU available for application use. See the [device datasheet](#) for details. This application note does not apply to single-core PSoC™ 6 MCU devices.

Generally, all memory and peripherals are shared by all bus masters. Shared resources are accessed through standard Arm multi-layer bus arbitration. Exclusive accesses are supported by an inter-processor communication (IPC) block, which implements semaphores and mutual exclusion (mutexes) in hardware.

A dual-core architecture, along with the DMA and cryptography (Crypto) bus masters, presents unique opportunities for system-level design and performance optimization in a single MCU. With two CPUs you can:

- Allocate tasks to CPUs so that multiple tasks may be done at the same time.
- Allocate resources to CPUs so that a CPU may be dedicated to managing those resources, improving efficiency.
- Enable and disable CPUs to minimize power draw.
- Send data between the CPUs using the IPC block. For more information, see the code example [mtb-example-psoc6-dual-cpu-ipc-pipes](#).

In one example application, the Cortex®-M0+ CPU (CM0+) can “own” and manage all communication channels. The Cortex®-M4 CPU (CM4) can send and receive messages from the channels via CM0+. This frees CM4 to do other tasks while CM0+ manages the communication details.

1.1 Tools and libraries

Infineon provides two development platforms that you can use for application development with PSoC™ 6 MCU:

- **ModusToolbox™:** ModusToolbox™ cross platform software includes configuration tools, low-level drivers, middleware libraries, and operating system support, as well as other packages that enable you to create MCU and wireless applications. It also includes the optional Eclipse IDE for ModusToolbox™.
- **PSoC™ Creator:** A Infineon-proprietary IDE that runs on Windows only. It supports a subset of PSoC™ 6 MCU devices as well as other PSoC™ device families such as PSoC™ 3, PSoC™ 4, and PSoC™ 5LP.

Both platforms provide a mechanism to load and run applications in third-party tools, such as Keil μVision, IAR Embedded Workbench and Visual Studio Code.

Infineon also provides a set of libraries to facilitate application development with PSoC™ 6 MCU:

- **Peripheral Driver Library (PDL):** PDL drivers abstract hardware functions into a set of easy to use APIs. For more information on the PDL, go to the [mtb-pdl-cat1](#) webpage. This library is available in PSoC™ Creator and ModusToolbox™ software.
- **Hardware Abstraction Layer (HAL):** HAL is built on top of the PDL. It provides a high-level interface to configure and use hardware blocks on Infineon MCUs. It is a generic interface that can be used across multiple product families. For more information on the HAL, go to the [mtb-hal-cat1](#) webpage. The HAL is available only in ModusToolbox™ software. PSoC™ Creator does not have support for HAL.
- **Middleware:** This category includes multiple libraries that implement APIs for various domains, capacitive sensing is one such example. A middleware library may be created by Infineon or come from a third party. In PSoC™ Creator, the middleware is usually available as a PSoC™ Creator Component. In ModusToolbox™ software, it is available as a library.
- **Board Support Package (BSP):** BSP provides a standard interface to a board’s features and capabilities. The API is consistent across Infineon kits. Other software (such as middleware or an application) can use the BSP to configure and control the hardware. The BSP is available in ModusToolbox™ software only. Although PSoC™ Creator does not offer BSP, you can install the kit software, allowing you to start a new project based on the selected kit.

1 Introduction

1.2 How to use this document

This document assumes that you are familiar with PSoC™ 6 MCU architecture, and application development for PSoC™ devices using either ModusToolbox™ software or PSoC™ Creator IDE. For an introduction to PSoC™ 6 MCU, see the following:

- A PSoC™ 6 MCU [device datasheet](#)
- [AN228571](#) - Getting Started with PSoC™ 6 MCU on ModusToolbox™ software
- [AN221774](#) - Getting Started with PSoC™ 6 MCU on PSoC™ Creator
- [AN210781](#) - Getting Started with PSoC™ 6 MCU with Bluetooth® low energy connectivity on PSoC™ Creator

If you are new to ModusToolbox™ software, see the [ModusToolbox™ software home page](#). Some PSoC™ 6 MCU devices are not supported by PSoC™ Creator; in this case, ModusToolbox™ software must be used. If you are using ModusToolbox™ software, make sure that it's version 3.0 or higher for designs based on PSoC™ 6 MCU devices with dual CPUs.

If you are new to PSoC™ Creator, see the [PSoC™ Creator home page](#). Use PSoC™ Creator version 4.3 or higher for PSoC™ 6 MCU-based designs.

Initial sections of this application note cover general concepts for dual-core MCUs and how they are implemented in PSoC™ 6 MCU. To skip to an overview of creating a ModusToolbox™ software or PSoC™ Creator project for a PSoC™ 6 dual-core MCU, go to the [PSoC™ 6 MCU dual-core development](#) section.

2 General dual-core concepts

2 General dual-core concepts

The process of developing firmware for a dual-core MCU is similar to that for a single-core MCU, except that you write code for two CPUs instead of one. You should also consider any need for inter-processor communication.

- **Performance:** The main advantage of having two CPUs is that you essentially multiply your CPU power and bandwidth. How to use that increased bandwidth depends on the tasks that your application must perform.
- **Single task:** A single-task application may be less of a fit for a dual-core MCU unless the application is large and complex. In PSoC™ 6 MCU, you can execute the task on one of the CPUs and put the other CPU to sleep to reduce power.
- **Dual task:** This is the most obvious fit; assign each task to a CPU. Assign the task with larger computing requirements to the higher-performance CPU, i.e., Cortex®-M4 in PSoC™ 6 MCU.
- **Multiple tasks:** Again, assign each task to a CPU. In each CPU, you must include a method for executing each task in a timely fashion.
- **RTOS:** A complex multitasking system may be managed by a real-time operating system (RTOS). An RTOS basically allocates a number of CPU cycles to each task, depending on the task priority or whether a task is waiting for an event. You effectively do that yourself by assigning tasks to the CPUs. Some examples of dual-core RTOS architectures are:
 - Each CPU has its own RTOS and its own set of tasks. Each RTOS should include a task to manage communications with the other CPU.
 - Only one CPU has an RTOS and multiple tasks. The other CPU is idle until it is messaged to do a specified task. It then wakes up and does the task, then messages the result back to the first CPU. As an example, the lower-performance CPU, CM0+ in PSoC™ 6 MCU, can use the higher-performance CPU, CM4 in PSoC™ 6 MCU, to do computation-intensive tasks when needed.
- **Power:** In a dual-core system, firmware can start and stop the CPUs to fine-tune power usage. In the previous example, to reduce power, the high-performance CPU is placed into a sleep state until needed for a computation-intensive task.
- **Debug:** Debugging two bodies of code at the same time may be a complex process. Usually you debug code for one CPU, then debug code for the other CPU. In addition, a device such as an oscilloscope or a logic analyzer may be useful for monitoring communication between the CPUs.

3 PSoC™ 6 MCU dual-core architecture

3 PSoC™ 6 MCU dual-core architecture

Figure 1 shows the overall dual-core architecture in PSoC™ 6 MCU. (For detailed block diagrams of PSoC™ 6 MCU, see the [device datasheet](#)) Specific features and other details related to dual CPUs are listed in this section. For more information, see the [ARM® documentation sets for Cortex® - M4](#) and [Cortex® -M0+](#), and the PSoC™ device [technical reference manual \(TRM\)](#).

- **CPUs:** Both CPUs –Cortex® M4 and Cortex® M0+ – are 32-bit. CM4 runs at up to 150 MHz and has a floating-point unit (FPU). CM0+ runs at up to 100 MHz.
- CM4 is the main CPU. It is designed for a short interrupt response time, high code density, and high throughput. The CM0+ CPU is secondary; it is used in PSoC™ 6 MCU to implement system calls and device-level security, safety, and protection features. CM0+ is also recommended for functions such as Bluetooth® LE communications and CAPSENSE™.
- **Performance:** CM0+ typically operates at a slower clock speed than CM4. The CM0+ instruction set is more limited than that of CM4. Therefore, it may require more cycles to implement a function on CM0+, and the cycle time is longer. Keep this in mind when deciding to which CPU to allocate tasks.
- **Security:** PSoC™ 6 MCU has several security features; see the [TRM](#) for details. To meet security requirements, CM0+ is used as a "secure CPU". It is considered to be a trusted entity; it executes Infineon system code and application code. The use of CM0+ for system and security tasks may limit its availability for applications. For more information, on secure systems, see [AN221111 - PSoC™ 6 MCU designing a custom secured system](#).

Device system calls may be initiated by either CPU but are always executed by CM0+.

- **Startup sequence:** After device reset, only CM0+ executes; CM4 is held in a reset state. CM0+ first executes Infineon system and security code, including SROM code, FlashBoot, and Secure Image. For more information on these code modules, see the Boot Code chapter of the Architecture [TRM](#) for details. After CM0+ executes the system and security code, it executes the application code. In the application code, CM0+ may release the CM4 reset, causing CM4 to start executing its application code. PSoC™ Creator [auto-generates code in CM0+ main\(\)](#) to release the CM4 reset. In ModusToolbox™ software, the BSP chooses and includes one of the several available CM0+ prebuilt images.
- **Inter-processor communication (IPC):** IPC enables the CPUs to communicate and synchronize activities. The IPC hardware contains register structures for IPC channel functions and IPC interrupts. IPC channel registers implement mutual exclusion (mutex) lock/release mechanisms, and messaging between the CPUs. IPC interrupt registers generate interrupts to both CPUs for messaging events and lock/release events.
- **Interrupts:** Each CPU has its own set of interrupts. All peripheral interrupt lines are hard-wired to specific CM4 interrupt inputs. Peripheral interrupts are also multiplexed to CM0+'s limited set of 8 interrupt inputs (32 interrupt inputs in the CY8C61x7, CY8C62x7, and CY8C63x7). See Interrupt Assignment Considerations.
- **Power modes:** PSoC™ 6 MCU has several power modes that can affect either the entire system or just a single CPU. CPU power modes are Active, Sleep, and Deep Sleep as defined by Arm®. Device system power modes are LP, ULP, Deep Sleep, and Hibernate.
 - System Low Power (LP) mode is the default operating mode of the device after reset. It provides the maximum performance. While in System LP mode, the CPUs may operate in any of the Arm®-defined modes.
 - System Ultra Low Power (ULP) mode is identical to LP mode with a performance tradeoff made to achieve a lower system current. This tradeoff lowers the core operating voltage, which then requires a reduced operating clock frequency, and limited high-frequency clock sources. While in system ULP mode, the CPUs may operate in any of the Arm®-defined modes.
 - In System Deep Sleep mode, all high-speed clock sources are OFF. This in turn stops both CPUs and makes high-speed peripherals unusable. However, low-speed clock sources and peripherals continue to operate, if configured and enabled by the firmware. Interrupts from these peripherals cause the

3 PSoC™ 6 MCU dual-core architecture

device to return to System LP or ULP mode and one or more CPUs to wake up to Active mode. Each CPU has a Wakeup Interrupt Controller (WIC) to wake up the CPU.

- System Hibernate mode is the lowest power mode of the device. It is intended for applications that may go into a dormant state. The device goes through a reset on wakeup from Hibernate. See [Startup sequence](#).
- In CPU Active mode, the CPU executes code and all logic and memory is powered. The device must be in System LP or ULP mode.
- In CPU Sleep mode, the CPU clock is turned OFF and the CPU halts code execution. The device must be in System LP or ULP mode.
- In CPU Deep Sleep mode, the CPU requests the device to go into System Deep Sleep mode. When the device is ready, it enters System Deep Sleep mode. In PSoC™ 6 MCU, both CPUs must enter CPU Deep Sleep before the system transitions to Deep Sleep. If only one CPU has entered CPU Deep Sleep mode, the system remains in LP or ULP mode.
- For more information on PSoC™ 6 MCU power modes, see [AN219528 - PSoC™ 6 MCU low-power modes and power reduction techniques](#).
- **Debug:** PSoC™ 6 MCU has a Debug Access Port (DAP) that acts as the interface for device programming and debug. An external programmer or debugger (the "host") communicates with the DAP through the device Serial Wire Debug (SWD) or Joint Test Action Group (JTAG) interface pins. Through the DAP (and subject to device security restrictions), the host can access the device memory and peripherals as well as the registers in both CPUs.
- Each CPU offers several debug and trace features as follows:
 - CM4 supports six hardware breakpoints and four watchpoints, 4-bit embedded trace macrocell (ETM), serial wire viewer (SWV), and printf()-style debugging through the single-wire output (SWO) pin.
 - CM0+ supports four hardware breakpoints and two watchpoints, and a micro trace buffer (MTB) with 4 KB dedicated RAM.

PSoC™ 6 MCU also has an [Embedded Cross Trigger](#) for synchronized debugging and tracing of both CPUs.

Some third-party IDEs support synchronized dual-core debugging; see [Debug considerations](#). Infineon's ModusToolbox™ software supports dual-core debugging (unsynchronized), and PSoC™ Creator supports debugging a single CPU (either CM4 or CM0+) at a time.

4 PSoC™ 6 MCU dual-core development

4 PSoC™ 6 MCU dual-core development

This section shows only those development aspects that are unique to PSoC™ 6 MCU dual-core devices. To learn more about PSoC™ 6 MCU, ModusToolbox™ software, or PSoC™ Creator, see one or more of the following:

- [AN228571](#) - Getting Started with PSoC™ 6 MCU on ModusToolbox™ software
- [AN221774](#) - Getting Started with PSoC™ 6 MCU on PSoC™ Creator
- [AN210781](#) - Getting Started with PSoC™ 6 MCU with Bluetooth® low energy connectivity on PSoC™ Creator
- The [ModusToolbox™ software home page](#). Some PSoC™ 6 MCU devices are not supported by PSoC™ Creator; in this case, ModusToolbox™ software must be used. If you are using ModusToolbox™ software, then make sure it's version 3.0 or higher for designs based on PSoC™ 6 MCU devices with dual CPUs
- The [PSoC™ Creator home page](#). Use PSoC™ Creator version 4.3 or higher for PSoC™ 6 MCU-based designs

4.1 ModusToolbox™ software instructions

ModusToolbox™ software application development for a PSoC™ 6 MCU dual-core device is similar to that for any other device supported by ModusToolbox™ software. By default, the Board Support Packages (BSP) that come with the ModusToolbox™ software provides several prebuilt CM0+ application images. This section explains how to create your own CM0+ application as a substitute for the prebuilt images.

To create a dual-core application, you can follow one of the following methods:

1. If you are starting dual-core application development from scratch, you can create your new application based on an existing dual-CPU code example hosted [here](#). You can use any code example with a repo name that includes “dual-CPU” as a start point. For most cases, the [mtb-example-psoc6-dual-cpu-empty-app](#) is a good choice.
2. If you have an existing single-core application that you want to convert to a dual-core application, follow the steps from [Creating a dual-core application](#) section.

4.1.1 Creating a dual-core application

This section shows how to create a dual-core application step-by-step by using an existing single-core application and a starter dual-core application. Here the starter dual-core application will act as a template defining the dual-core application structure. The existing single-core application's contents can easily be copied into the starter dual-core application.

For the single-core application, as an example, the [mtb-example-psoc6-hello-world](#) is chosen. For the starter dual-core application, the [mtb-example-psoc6-dual-cpu-empty-app](#) is chosen. The CY8CPROTO-062S2-43439 BSP is chosen for both applications.

The applications can be created using one of the following methods:

- [Eclipse IDE for ModusToolbox™](#)
- [Command-line Interface \(CLI\)](#)

4.1.1.1 Eclipse IDE for ModusToolbox™

1. Launch Eclipse IDE for ModusToolbox™ 3.0 or later and select a workspace.
2. From the **Quick Panel**, click **New Application**.
3. Once the project creator wizard opens, expand **PSoC™ 6 BSPs** and select **CY8CPROTO-062S2-43439**. Click **Next**.
4. In the new window, expand **Getting Started**, select **Dual-CPU Empty PSoC6 App** and **Hello World**. Click **Create**.
5. In [Figure 2](#), you see both applications created in the workspace.

4 PSoC™ 6 MCU dual-core development

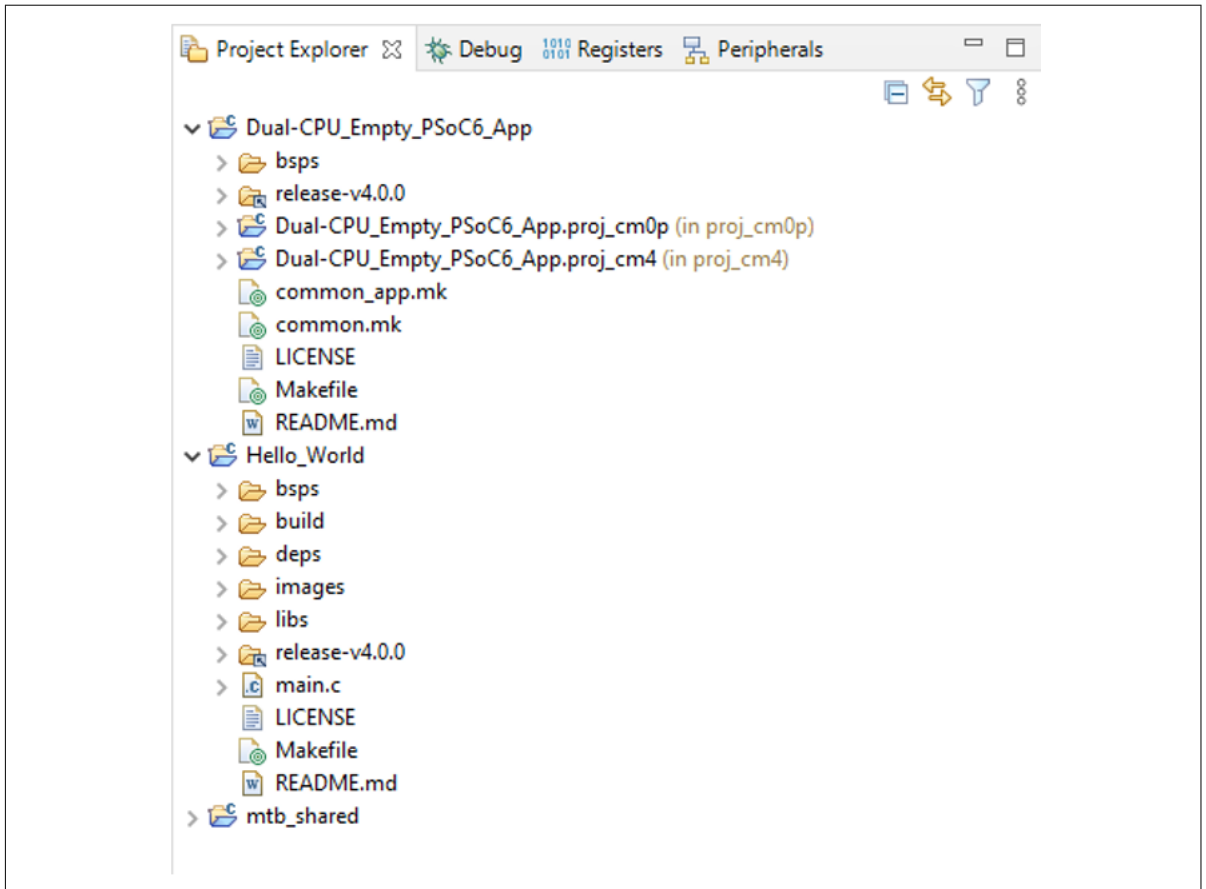

Figure 2 Workspace in ModusToolbox™ containing both single-core and dual-core applications

4.1.1.2 Command-line Interface (CLI)

1. For project creation, open a CLI terminal and navigate to ModusToolbox™ software installation folder such as <install_path>/ModusToolbox/tools_<version>/project-creator/.
2. Create both the applications by executing the following project-creator-cli commands.

```
project-creator-cli \
--board-id CY8CPROTO-062S2-43439 \
--app-id mtb-example-psoc6-hello-world \
--user-app-name Hello_World \
--target-dir "C:/workspace_directory"
```

```
project-creator-cli \
--board-id CY8CPROTO-062S2-43439 \
--app-id mtb-example-psoc6-dual-cpu-empty-app \
--user-app-name Dual-CPU_Empty_PSoC6_App \
--target-dir "C:/workspace_directory"
```

Alternatively, you can execute the **project-creator** tool in the same folder and follow the same steps described in [Eclipse IDE for ModusToolbox™](#).

For more information, see Section 2.3 in the [ModusToolbox™ user guide](#).

4 PSoC™ 6 MCU dual-core development

4.1.1.3 Modify application contents

The following contents from the Hello World example need to be selectively copied to the CM4 project (proj_cm4) of the Dual CPU Empty application:

- 1. Makefile variables** – Open the `Makefile` of the Hello World application and `proj_cm4` application side-by-side. Compare and copy the variable values from the Hello World `Makefile` to the `proj_cm4` `Makefile`. If some of the variables defined in the Hello World `Makefile` are not present in the `proj_cm4` `Makefile`, they should be available in the `common.mk` and `common_app.mk` `Makefiles` at the root level of the dual-core empty application.

Current values of variables such as `MTB_TYPE`, `APPNAME`, `COMPONENTS`, and `DISABLE_COMPONENTS` in the Dual CPU Empty application `Makefiles` should not be deleted or modified. Adding new values is still allowed for variables such as `COMPONENTS` and `DISABLE_COMPONENTS`.

For the Hello World application case, there are no `Makefile` variables that need to be copied.

- 2. Source files** – Replace all the source files from the `proj_cm4` application with the Hello World application.
- 3. Libraries/Middleware** – The libraries or middleware used in the Hello World application should also be added to the `proj_cm4` application. Follow these steps to add them:
 - a.** In the Eclipse IDE of ModusToolbox™, from the quick panel launch **Library Manager** tool. Alternatively, you can launch the Library Manager from the tools folder of ModusToolbox™ installation directory, in this case the correct path to the Dual CPU Empty application needs to be selected from the Library Manager window.
 - b.** Once the **Library Manager** opens, click **Add Library**.
 - c.** Select **Target Project** as `proj_cm4`.
 - d.** Under **Peripheral**, select `retarget-io` library, and click **OK**.
 - e.** Click **Update** from the **Library Manager** window. Wait for the libraries to get added; see the log messages for progress.
 - f.** Once the libraries are updated, click **Close**.

The CM0+ project (`proj_cm0p`) of the Dual CPU Empty application enables the CM4 core and goes to Deep Sleep. To use the core for any other purpose, the `cybsp_init()` function needs to be called from the CM0+ core. This function will do all the system-level initialization required to run peripherals on the CM0+ core. Modify the `main.c` file of `proj_cm0p` as shown in [Code Listing 1](#).

4 PSoC™ 6 MCU dual-core development

Code Listing 1

```

#include "cy_pdl.h"
#include "cycfg.h"
#include "cybsp.h"
int main(void)
{
    cy_rslt_t result;

    /* Initialize the device and board peripherals */
    result = cybsp_init();
    if (result != CY_RSLT_SUCCESS)
    {
        CY_ASSERT(0);
    }

    /* Enable global interrupts */
    __enable_irq();

    /* Enable CM4. CY_CORTEX_M4_APPL_ADDR must be updated if CM4 memory layout is changed. */
    Cy_SysEnableCM4(CY_CORTEX_M4_APPL_ADDR);

    for (;;)
    {
        Cy_SysPm_DeepSleep(CY_SYSPM_WAIT_FOR_INTERRUPT);
    }
}

```

The Infineon HAL is not yet designed to run simultaneously on CM0+ and CM4 core. Since the `proj_cm4` already uses HAL, `proj_cm0p` should only use PDL APIs.

4.1.1.4 Build and program

The application can be built and programmed using one of the following methods:

- Using Eclipse IDE for ModusToolbox™
 1. Select the **Dual-CPU_Empty_PSoC6_App** application from the project explorer.
 2. From the quick panel, select **Dual-CPU_Empty_PSoC6_App Program MultiCore (KitProg3)**. This will build and program both projects – `proj_cm0p` and `proj_cm4`, one after the other.
 3. Alternatively, you can program individual projects (`proj_cm0p` or `proj_cm4`), but this is only possible through CLI interface as explained below.
- Using Command-line Interface (CLI)
 1. Open a modus-shell and navigate it to the root directory of the **Dual-CPU_Empty_PSoC6_App** application.
 2. Run command `- make program`. This will build and program both projects – `proj_cm0p` and `proj_cm4`, one after the other.
 3. Alternatively, you can program individual projects (`proj_cm0p` or `proj_cm4`). Navigate the `modus-shell` to the required project directory. Run command `- make program_proj`.

4 PSoC™ 6 MCU dual-core development

The build artifacts for each project is generated in its own project directory under a folder named `build`. Note that the `build` folder in the application level has a copy of the project hex files. It also has a combined hex file containing the data of individual project hex files.

If the projects fail to build due to a flash overflow error, follow the steps from the [Customizing linker scripts](#) section to allocate the required memory for each project.

4.1.2 Customizing linker scripts

The CM0+ and CM4 projects each have their own linker scripts supplied by the BSP. By default, the CM0+ CPU consumes only 8192 [0x2000] bytes of flash and 8192 [0x2000] bytes of SRAM. If your CM0+ project requires more memory, both linker scripts require changes. Note that the increment/decrement in flash size should be in multiples of flash row size (512 bytes). The following steps list the changes:

1. The CM0+ linker script is located at directory - `bsps/TARGET_APP_<BSP_NAME>/COMPONENT_CM0P/`
By default, the BSP supports the ARM (*.sct), GCC_ARM (*.ld), and IAR (*.icf) toolchains. Each toolchain has its own linker script.

2. Edit the FLASH and SRAM size as desired:

Toolchain:	Where to change
ARM (*.sct)	<code>#define RAM_SIZE 0x00002000</code> <code>#define FLASH_SIZE 0x00002000</code>
GCC_ARM (*.ld)	<code>ram (rwx) : ORIGIN = 0x08000000, LENGTH = 0x2000</code> <code>flash (rx) : ORIGIN = 0x10000000, LENGTH = 0x2000</code>
IAR (*.icf)	<code>define symbol __ICFEDIT_region_IRAM1_end__ = 0x08001FFF;</code> <code>define symbol __ICFEDIT_region_IROM1_end__ = 0x10001FFF;</code>

3. The CM4 linker script is located at directory - `bsps/TARGET_APP_<BSP_NAME>/COMPONENT_CM4/`

4. Edit the values based on the CM0+ memory size:

Toolchain:	Where to change
ARM (*.sct)	<code>#define RAM_START 0x08002000</code> <code>#define RAM_SIZE 0x000FD800</code> <code>#define FLASH_CM0P_SIZE 0x2000</code>
GCC_ARM (*.ld)	<code>FLASH_CM0P_SIZE = 0x2000;</code> <code>ram (rwx) : ORIGIN = 0x08002000, LENGTH = 0xFD800</code>
IAR (*.icf)	<code>define symbol __ICFEDIT_region_IRAM1_start__ = 0x08002000;</code> <code>define symbol __ICFEDIT_region_IRAM1_end__ = 0x080FF7FF;</code>

5. In the CM0+ `Makefile`, add to `DEFINES` the CM4 application address (`CY_CORTEX_M4_APPL_ADDR`). For example, if the size of CM0+ image is 0x8000, set it to:

```
DEFINES=CY_CORTEX_M4_APPL_ADDR=0x10008000
```

4.1.3 Sharing libraries and peripherals

The `deps` folder of each project contains the list of libraries used by that project. As described earlier ModusToolbox™ provides a tool to manage the libraries and BSPs, called Library Manager. You can launch this tool from the Eclipse IDE for ModusToolbox™, **Quick Panel > Tools > Library Manager**. Alternatively, you can execute the **library-manager** tool located at this folder: (`<install_path>/ModusToolbox/tools_<version>/library-manager/`).

4 PSoC™ 6 MCU dual-core development

The BSPs added through the library manager by default will be downloaded to a folder named `bsps` located at the root directory of the dual CPU application. Both projects share the BSPs in an application.

The libraries added through the library manager by default will be downloaded to a folder named `mtb_shared`, located one level above the root directory of the dual CPU application. The libraries can be shared or project-specific. When adding the libraries through the library manager, an option is provided to select the project it belongs to. If the same library is added to both the projects, then both the projects can access the same library copy from the `mtb_shared` directory.

If a peripheral is shared, you should only initialize it in one of the CPUs and use some sort of mutex or synchronization mechanism to avoid both CPUs using it at the same time. It is not recommended to use the HAL for shared peripherals, since the CM0+ would not have access to the HAL object created by the CM4.

4 PSoC™ 6 MCU dual-core development

4.2 PSoC™ Creator instructions

PSoC™ Creator project development for a PSoC™ 6 MCU dual-core device is similar to that for any other device supported by PSoC™ Creator. To create a new project, select **File > New > Project**. A **Create Project** dialog is displayed, as shown in Figure 3.

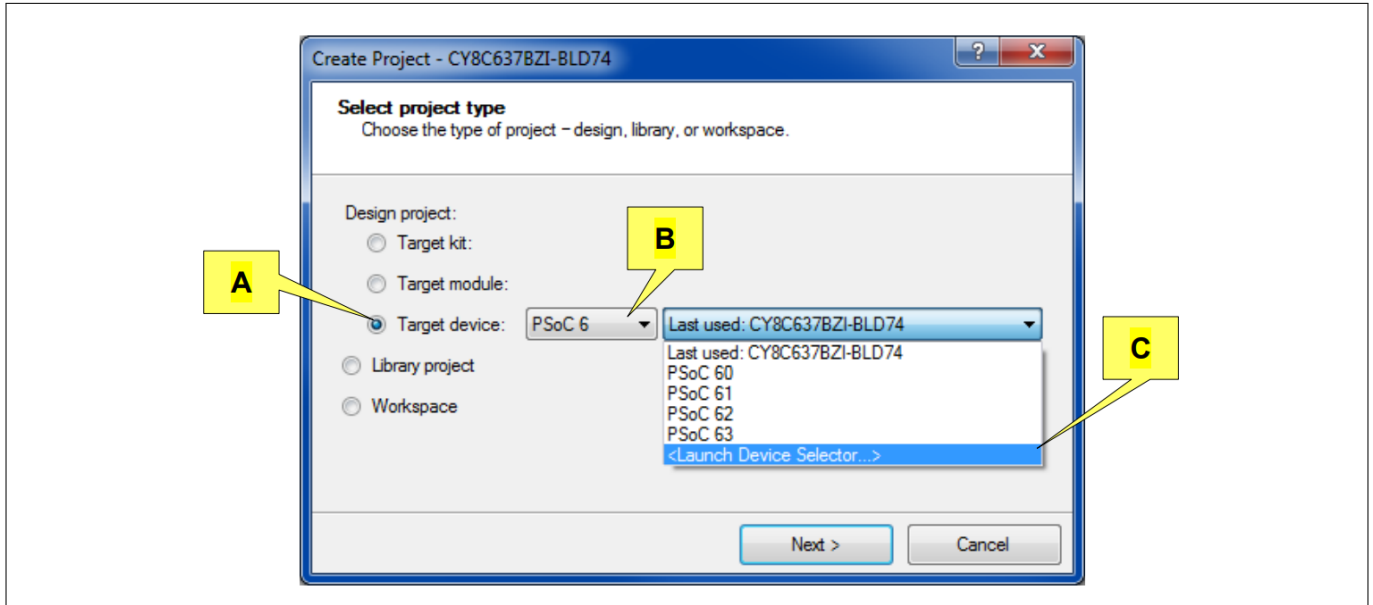

Figure 3 PSoC™ Creator create project dialog

Select **Target Device** (A), and **PSoC 6** (B). On the pull-down list (C), select **<Launch Device Selector...>** to see a list of PSoC™ 6 devices.

Figure 4 shows the Device Selector dialog. To see a list of dual-core devices, click the **CPU** category (D) and select only **CortexM0p, CortexM4**.

In the PSoC™ 6 Bluetooth® LE Pioneer Kit **CY8CKIT -062- BLE**, the PSoC™ 6 MCU dual-core device part number is CY8C6347BZI-BLD53. In the PSoC™ 6 Wi-Fi Bluetooth® Pioneer Kit **CY8CKIT -062- WiFi -BT**, the PSoC™ 6 MCU dual-core device part number is CY8C6247BZI-D54.

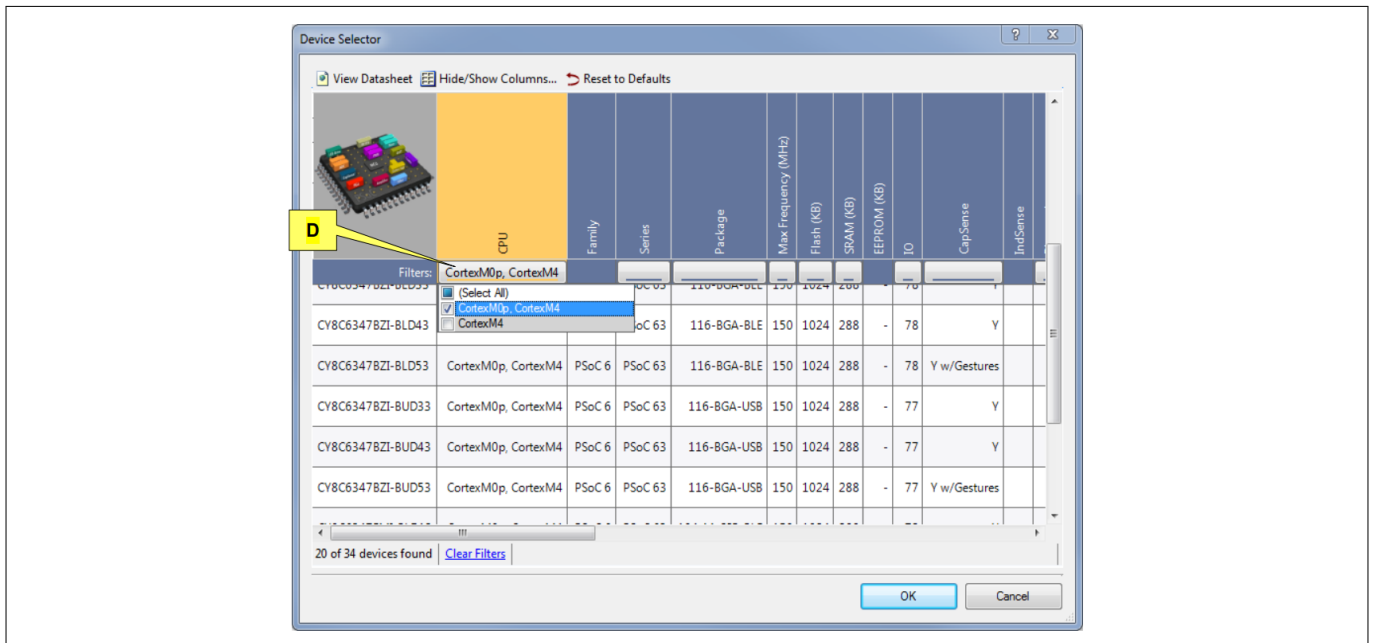

Figure 4 PSoC™ Creator device selector dialog

4 PSoC™ 6 MCU dual-core development

After selecting a PSoC™ 6 MCU part, the rest of the project creation process is the same as for other devices. Click through the rest of the **Create Project** dialogs; PSoC™ Creator creates the project.

The initial project windows layout (Figure 5) includes a **Workspace Explorer** window with the following features for dual-core devices:

- Separate main.c files – main_cm0p.c and main_cm4.c – for each CPU. Sources in the folders CM0p (Core 0) and CM4 (Core 1) are compiled into separate binaries for the respective CPUs.
- A Shared Files folder. Source files in this folder are compiled into both binaries.

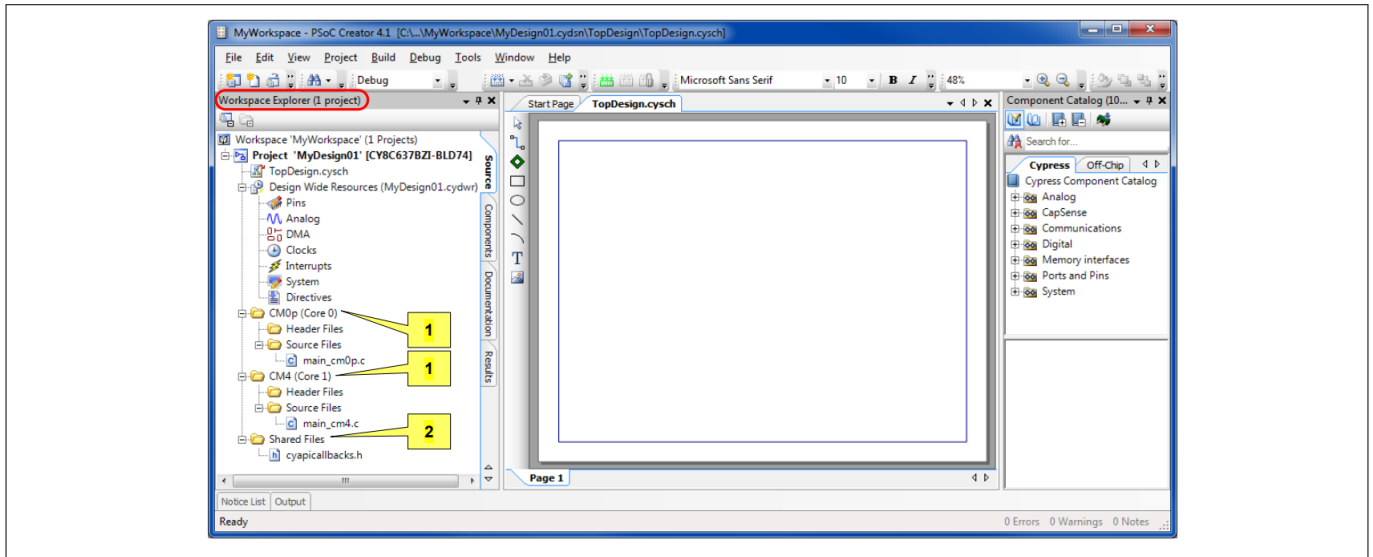

Figure 5 PSoC™ Creator initial project layout for dual-core devices

The initial project layout also includes a TopDesign hardware schematic, along with an associated component catalog window.

After the project is created, implement your hardware design by dragging Components onto the schematic, and configuring and wiring them.

When schematic design entry is complete, select **Build > Generate Application**. This creates several system source code files and folders in the existing folders as well as in the new folder Generated Source, as Figure 6 shows.

The generated source contains drivers for each Component on the schematic, as well as Infineon's peripheral driver library (PDL). The PDL is a software development kit (SDK) that integrates device header files, start-up code, and peripheral drivers. The peripheral drivers abstract the hardware functions into a set of easy-to-use APIs.

For more information on the PDL, select PSoC™ Creator **Help > Documentation > Peripheral Driver Library**. Also, each Component has a datasheet that documents the driver API for that Component. Right-click the Component and select **Open Datasheet...**

PSoC™ Creator IDE creates several other files and folders, and places them in existing folders CM0p (Core 0), CM4 (Core 1), and Shared Files. These files generally support configuration, start-up, and linking options for PSoC™ Creator as well as other IDEs. For more information on these files, see PSoC™ Creator Help article, Generated Files (PSoC™ 6).

4 PSoC™ 6 MCU dual-core development

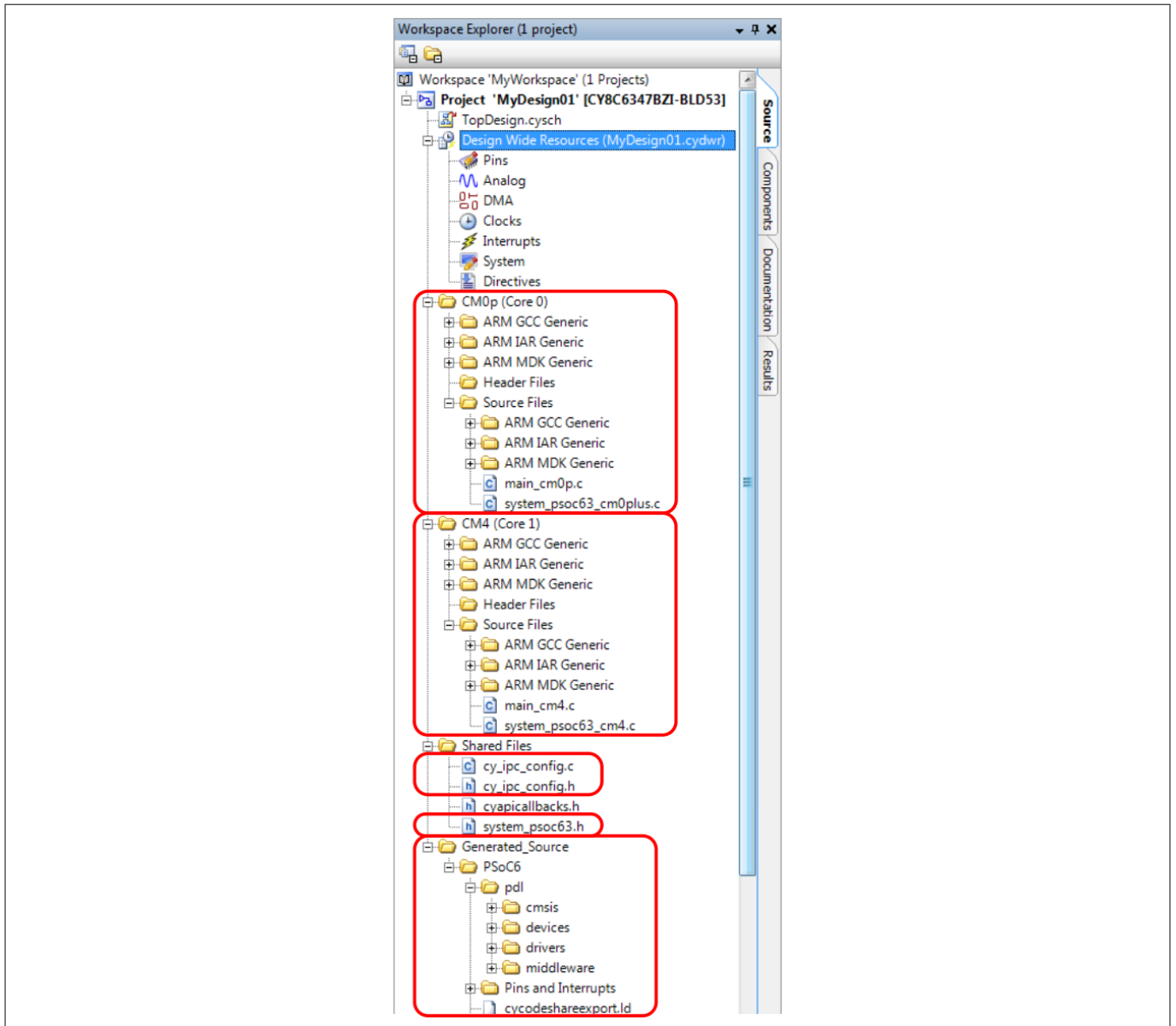

Figure 6 Add generated source to a project

4 PSoC™ 6 MCU dual-core development

4.3 Resource assignment considerations

All PDL driver source and other API files are available to both CPUs. If code for a CPU references any API element in a generated source file, that file is compiled into the binary for that CPU. The same file can be compiled into both binaries – see code example [CE216795](#), PSoC™ 6 MCU dual-CPU basics.

Note: Customers using PSoC™ Creator should download the required examples inside the tool using the project creation wizard. The PSoC™ Creator code example links provided in this document point only to the code example document.

If the same source file is compiled into both binaries, a function in that file is duplicated in both binaries. Even though the copies are in separate builds and binaries, in some cases it is convenient to consider a function to be executed simultaneously by both CPUs.

As noted previously, it is possible for a peripheral to be accessed by both CPUs; for example, both CPUs may send data through the same UART.

There are two ways to do resource management:

- **Dedicate a resource to one CPU.** Include code to use the resource only in the firmware for the desired CPU. Also, if you are using PSoC™ Creator, a good practice is to indicate on the project schematic the CPU that “owns” the resource, as [Figure 7](#) shows

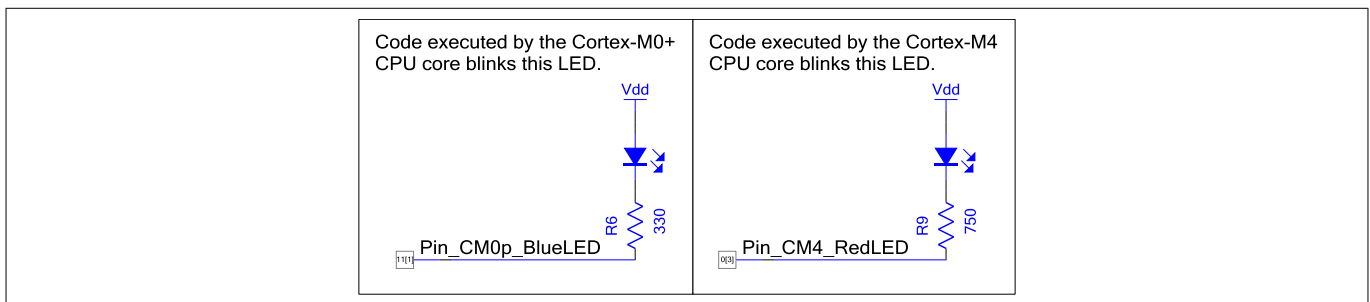

Figure 7 PSoC™ Creator project schematic for dual CPUs controlling separate pin components

- **Share resources between the CPUs.** Code example [CE216795](#) shows how the PSoC™ 6 MCU’s IPC block may be used to implement a mutex to share memory between the CPUs. Use the same technique to share a peripheral resource such as a UART

Flash and SRAM that are allocated in a CPU’s binary are generally separate from that for the other CPU. If custom sections and section placement are defined in the CPUs’ linker scripts, you must ensure that the sections do not overlap. Conversely, another way to share memory is to define for each CPU custom sections with the same address.

4.4 Power mode transition considerations

Resources such as system clocks are always shared between CPUs and all peripherals. The `cybsp_init()` function calls `cybsp_register_sysclk_pm_callback()` function. This function registers a power management callback that prepares the clock system for Deep Sleep mode and restores the clocks upon wakeup from a Deep Sleep.

The default `cybsp_register_sysclk_pm_callback()` is designed for single CPU examples, where CM0+ is in a Deep Sleep. If the CM4 CPU is also put to Deep Sleep, the callback function disables the clock system. This will not cause any problem to the CM0+ CPU as it is already in a Deep Sleep. In the case of dual CPU examples, this is not the case. If one of the CPUs goes to Deep Sleep, the callback doesn’t check the state of the other CPUs and disables the clock system. This causes the other active CPUs to misbehave.

To avoid the above issue, a custom power management callback function is needed. In this custom callback, you can decide whether to disable the system clocks or not. You can also implement any other custom

4 PSoC™ 6 MCU dual-core development

functions required for your application when performing a power mode transition. See the default callback function implementation to write your custom callback in the correct format.

Follow these steps to create and call a custom power management callback function:

1. From the root of your dual CPU example, create a shared folder to add source files.
For example: `shared/source/`
2. Create a C file with any name.
For example: `shared/source/custom_pm_callback.c`
3. Open the file and write a custom callback function with the exact same definition and name as shown below:

```

cy_rslt_t cybsp_register_custom_sysclk_pm_callback(void)
{
    . . .
}
    
```

4. Open the Makefiles of both CM0p and CM4 projects. Make the following changes:
 - a. Edit the SOURCES variable to add the newly created C file to the build process.
`SOURCES= ../shared/source/custom_pm_callback.c`
 - b. Add `CYBSP_CUSTOM_SYSCCLK_PM_CALLBACK` macro to the DEFINES variable.

4.5 IPC configuration considerations

Inter-Process Communication (IPC) provides the functionality for multiple CPUs to communicate and synchronize their activities. Following are some of the guidelines one needs to consider while using IPC:

1. The shared memory used for IPC communication can be placed in an unprotected public RAM region. This `public_ram` region is defined and commented in the default `CM0+` linker script provided by the target BSP. To use this public RAM region, uncomment the `public_ram` line and `.cy_sharedmem` section in the `CM0+` linker script.
2. The `public_ram` region must be given executable privileges to allow for flash write functions to run out of the SRAM. This can be achieved by changing the `rw` parameter to `rwX` parameter in the `public_ram` line of the `CM0+` linker script.
3. If the `public_ram` region is not used, the shared memory will be allocated in the SRAM region defined for the `CM0+` CPU.
4. When using protection units, the user application should take care not to protect the shared memory region.

4.6 Interrupt assignment considerations

An important consideration for dual-core designs is assigning and handling interrupts. As noted previously, all device interrupts are available to CM4, and a subset of interrupts are routed through multiplexers to CM0+. You must decide which CPU will handle each interrupt.

For more information, see application note [AN217666 - PSoC™ 6 MCU interrupts](#).

ModusToolbox™ software: In ModusToolbox™ software, interrupts are assigned programmatically; at this time, there is no GUI support. Examples of the required code are in [AN217666](#); and in the PDL/HAL documentation, Infineon Bluetooth® LE Middleware Library section, Configure BLESS interrupt subsection. The code in this subsection shows how to assign PSoC™ 6 MCU Bluetooth® LE subsystem (BLESS) interrupts to either CM0+ or CM4. The code can be easily modified to support other interrupt sources. If you are using Infineon HAL, all interrupts required by a HAL driver are assigned to the CPU calling the HAL functions.

4 PSoC™ 6 MCU dual-core development

Note: In CY8C61x6/7, CY8C62x6/7, and CY8C63xx devices, the CM0+ CPU is only capable of handling 32 system interrupts, out of which only 8 are deep sleep capable. If HAL functions are being used to initialize peripherals which require interrupts, the function will return “none free error” when all interrupts lines are fully utilized.

PSoC™ Creator: For PSoC™ Creator, let us assign interrupts in an example design. Figure 8 shows a design with two interrupts; one from a PWM Component, connected to an Interrupt Component MyPWM_Int; and the other from an I2C Component.

In the Design wide Resources window (file type .cydwr), select the **Interrupts** tab to see all of the interrupts in the design, as Figure 9 shows.

In this example, the I2C component has an interrupt embedded in it. That interrupt is not shown on the schematic in Figure 8; it is shown in the Design-Wide Resources window as MyI2C_SCB_IRQ.

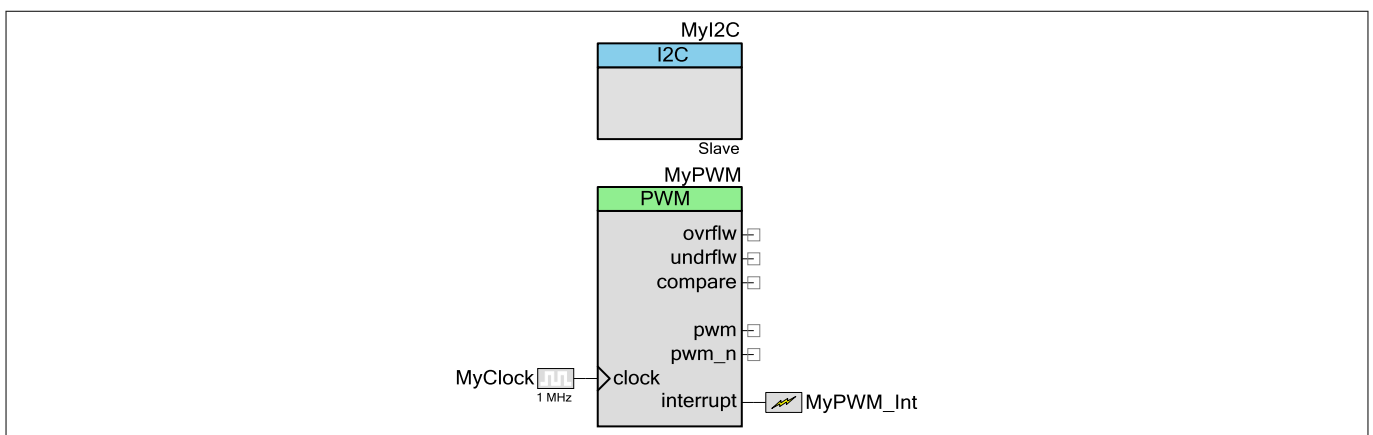

Figure 8 Example schematic design with two interrupts

Check or uncheck the boxes in the **Arm® CM0+ Enable** and **Arm® CM4 Enable** columns to assign interrupts to the respective CPUs.

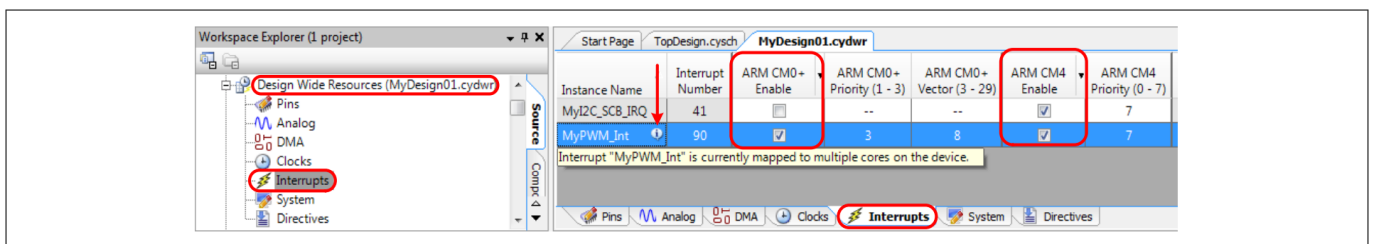

Figure 9 Assign interrupts to the CPUs

Each peripheral interrupt is hard-wired to CM4, so the **Interrupt Number** is automatically assigned by PSoC™ Creator when you build the project. Because interrupts are routed through multiplexers to CM0+, you can select an **Arm® CM0+ Vector** for each interrupt.

Note: A warning symbol and tooltip are displayed if an interrupt is assigned to both CPUs. This is generally not recommended; however, an interrupt can be used to wake up one or both CPUs from their **Sleep modes**.

4.7 Debug considerations

Third-party IDEs such as Keil μVision and IAR Embedded Workbench support dual-core debugging. Eclipse IDE for ModusToolbox™ software supports dual-core debugging (unsynchronized), and PSoC™ Creator supports debugging a single CPU (either CM4 or CM0+) at a time.

4 PSoC™ 6 MCU dual-core development

4.7.1 ModusToolbox™ instructions

Eclipse IDE for ModusToolbox™ software supports asynchronous dual core debugging. You can launch the debug session for both cores simultaneously, but debug activities (For example, halt, stop, breakpoints) on one core will not affect the other. For detailed instructions, open the [ModusToolbox™ User Guide](#), and see the subsection **PSoC™ 6 MCU Programming/Debugging**.

4.7.2 PSoC™ Creator instructions

PSoC™ Creator supports debugging just one CPU at a time. Before starting a debug session with PSoC™ 6 MCU, select the desired debug target (**Debug > Select Debug Target...**), as [Figure 10](#) shows. Select the desired CPU and click **OK/Connect**. To debug the other CPU, you must exit the debugger and then re-enter it with a connection to that CPU.

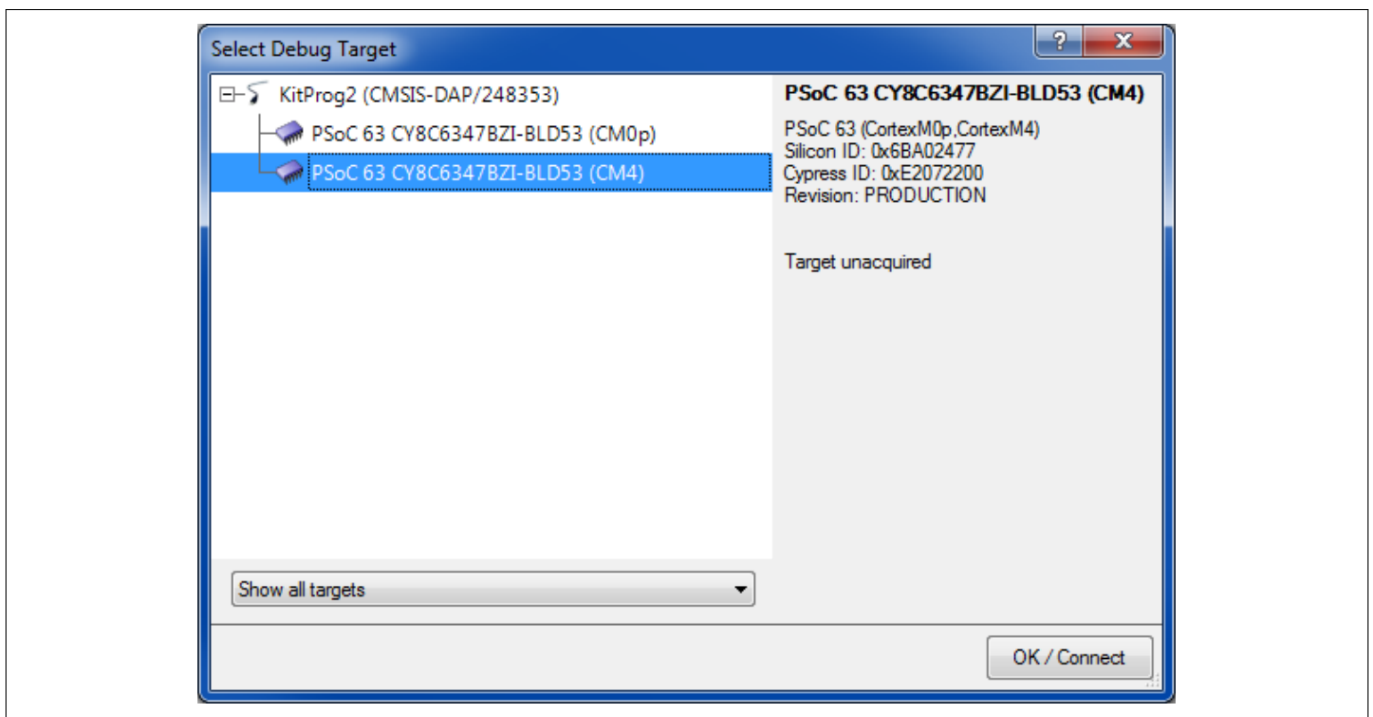

Figure 10 PSoC™ Creator select CPU for debug

Recommended: Develop and debug first the portions of code where the CPUs communicate with each other. After that, code executed by an individual CPU can be debugged separately. For example, when the shared memory project in [CE216795](#) was developed, the portion where CM0+ sends an initial message to CM4 was developed and debugged before subsequent portions of code were developed.

You can debug both CPUs simultaneously by using other IDEs such as µVision or IAR. To do so, you must export your PSoC™ Creator project to the other IDE. PSoC™ Creator documents this topic in the help articles [Integrating into 3rd Party IDEs](#), [PSoC™ 6 Designs](#). Review the instructions in the help articles; the general steps are summarized in the following sections.

4.7.3 Instructions for other IDEs

4.7.3.1 Exporting ModusToolbox™ applications to supported IDEs

ModusToolbox™ software has a mechanism to load and run applications on the following IDEs:

- IAR Embedded Workbench

4 PSoC™ 6 MCU dual-core development

- Keil µVision
- Visual Studio Code

For more details on how to export and set up debugging with these tools, see the “Exporting to IDEs” chapter in the [ModusToolbox™ user guide](#).

4.7.3.2 Exporting from PSoC™ Creator

If you are using PSoC™ Creator, you can export your project to Keil µVision or IAR Embedded Workbench for dual-core debugging. Following are the steps to do so:

1. [Configure the PSoC™ Creator Project](#)
2. [Create µVision Projects](#)
3. [Debug µVision Projects](#)
4. [Create IAR-EW Projects](#)
5. [Debug IAR-EW Projects](#)

1. Configure the PSoC™ Creator Project

Update the **Target IDEs** settings in the project Build Settings, as [Figure 11](#) shows

For µVision, select **CMSIS Pack: > Generate**. Enter appropriate identifying text for the CMSIS pack in the **Vendor**, **Pack**, and **Version** fields

Recommended: select **Toolchain: > ARM MDK Generic**

For IAR, you only need to select **IAR EW-ARM: > Generate**. (An advanced option, **Generate without copying PDL files**, is also available.) IAR has its own compiler (not supported by PSoC™ Creator), so the Toolchain selection is irrelevant

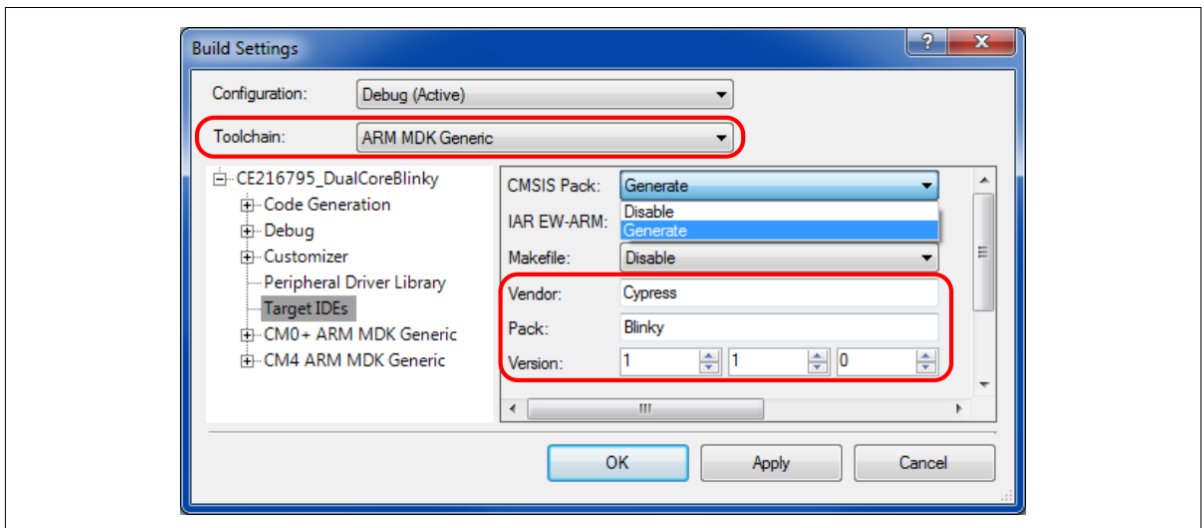

Figure 11 Build settings for target IDEs

Then build your PSoC™ Creator project in the usual manner. A folder Export is created in your <project>.cydsn folder, which contains relevant files for exporting to the selected IDE or IDEs

For µVision, after the PSoC™ Creator project is built, find the corresponding .pack file in the folder Export \ Pack. Double-click the file to install it as a µVision pack, as [Figure 12](#) shows.

Note: Do not use the µVision Pack Installer Wizard File Import function to install this pack.

4 PSoC™ 6 MCU dual-core development

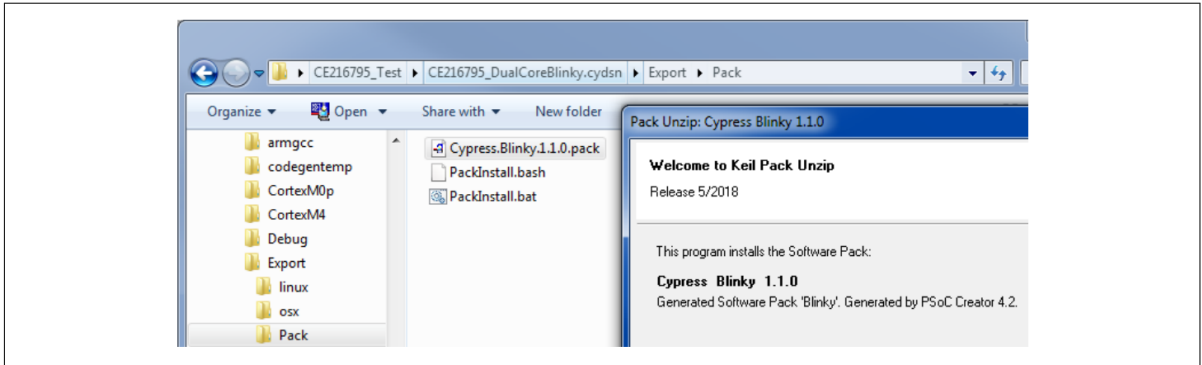

Figure 12 Install μ Vision pack from PSoC™ Creator project

if you update the PSoC™ Creator project, consider changing the μ Vision pack version number (see [Figure 11](#)) and installing the new pack

For more information, see [AN219434 - Importing PSoC™ Creator Code into an IDE for a PSoC™ 6 Project](#)

2. **Create μ Vision projects**

For μ Vision, you must create two projects: one for each PSoC™ 6 MCU CPU: CM0+ and CM4. Do the following:

Recommended: create a new folder (For example, `μ visionBuild`) within your PSoC™ Creator <project>. `cydsn` folder to store all μ Vision project files separately from the PSoC™ Creator files (this is different from the [IAR instructions](#)). Within that folder, create another new folder for CM4 object files (For example, `objectsM4`), as [Figure 13](#) shows:

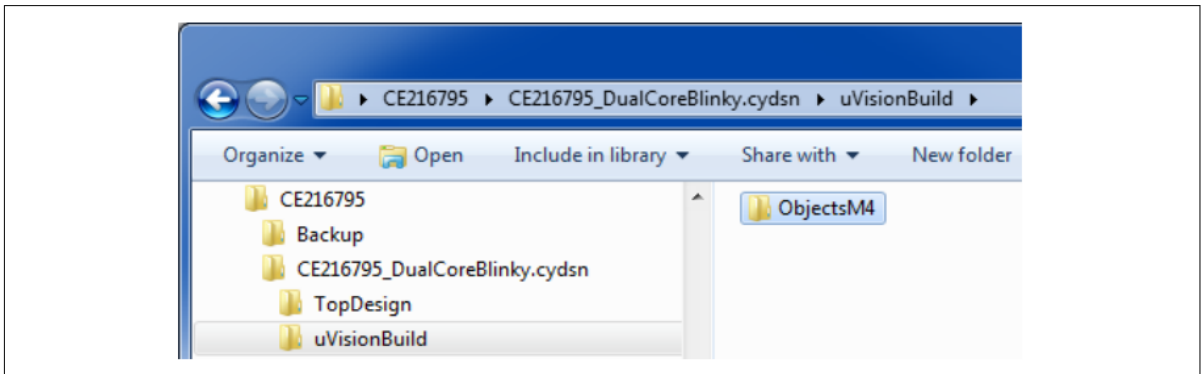

Figure 13 New folders for μ Vision projects

Open μ Vision 5.25 or later and create a new project (**Project > New μ Vision Project...**) in the `μ visionBuild` folder

Recommended: name the project based on the original PSoC™ Creator project name and the target CPU. For example, for the [CE216795](#) dual-core blinky project, create a μ Vision project `BlinkyM0p` for the CM0+ CPU, as [Figure 14](#) shows:

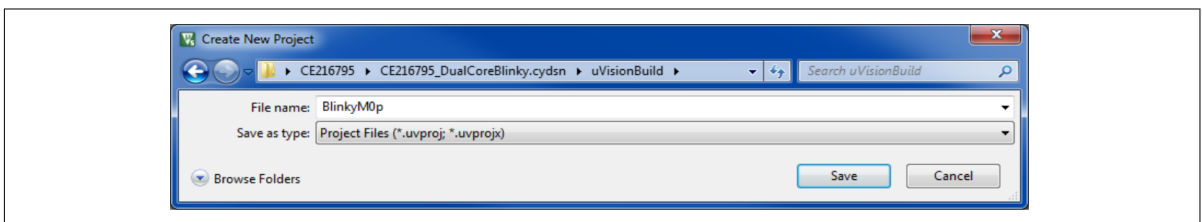

Figure 14 Create a μ Vision project for CM0+

4 PSoC™ 6 MCU dual-core development

After you click **Save**, a **Select Device for Target ‘Target 1’...** dialog box is displayed. The two PSoC™ 6 MCU CPUs that were defined in the previously installed pack (Figure 12) are displayed. Select the CM0+ CPU, as Figure 15 shows. Click **OK**.

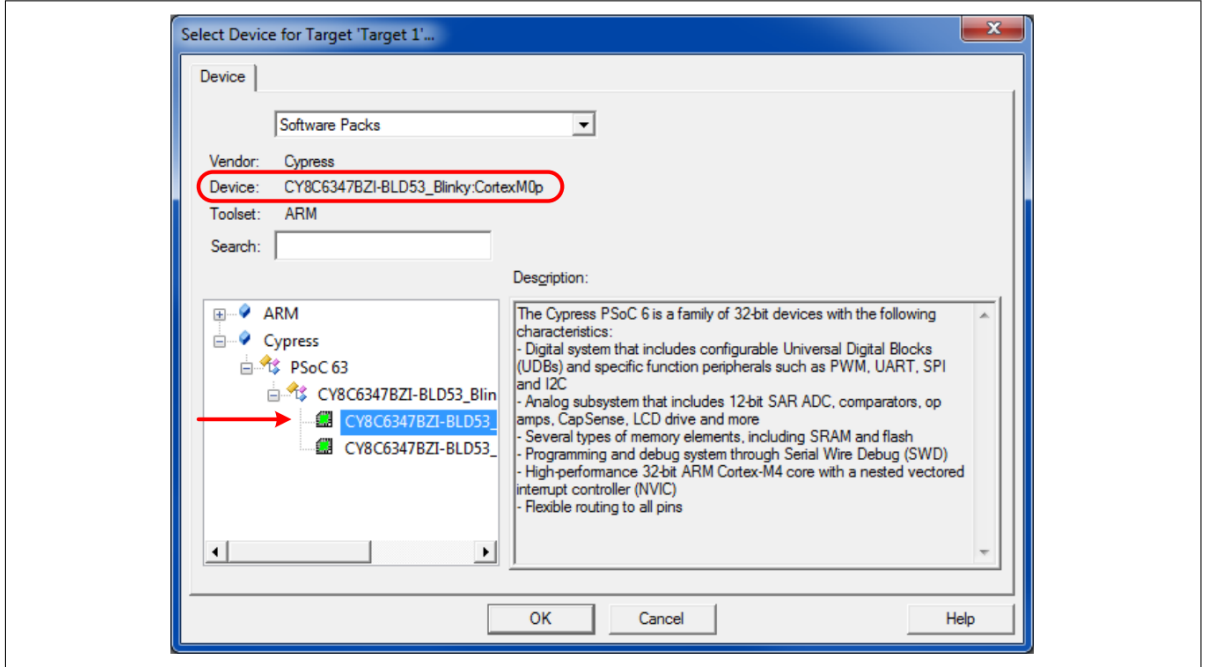

Figure 15 Select CM0+ as the project device

Next, a **Manage Run-Time Environment** dialog box is displayed. Click **Select Packs** and uncheck **Use latest versions of all installed Software Packs**. Select the pack from the PSoC™ Creator project, as Figure 16 shows:

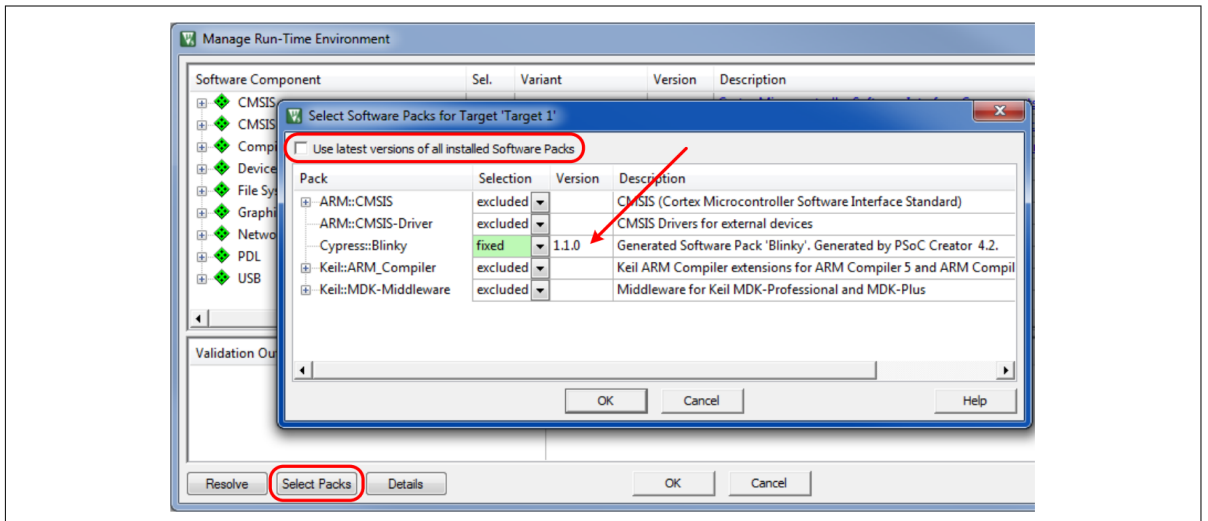

Figure 16 Select the PSoC™ Creator project pack

Click **OK**; the **Manage Run-Time Environment** dialog changes as Figure 17 shows. Select the Device Startup and PDL Drivers and click **OK**. The project is created, with a Target 1, a Source Group 1, and Device startup and PDL files, as Figure 18 shows

4 PSoC™ 6 MCU dual-core development

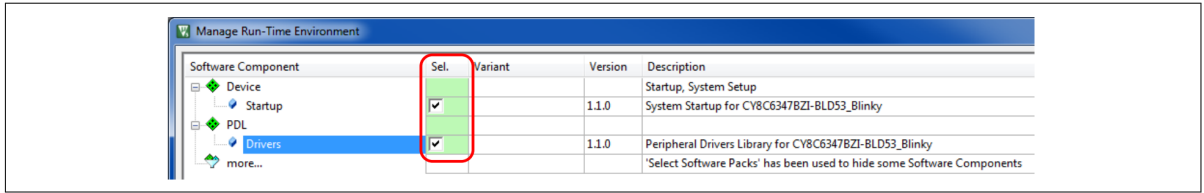

Figure 17 Select pack start-up and PDL driver files

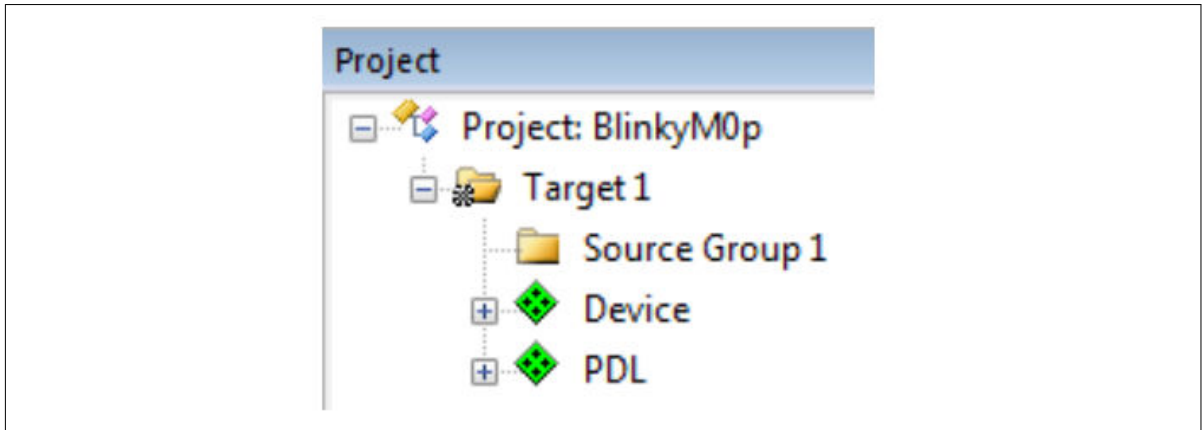

Figure 18 Initial project creation

Right-click **Source Group 1**, and select **Add Existing Files to Group 'Source Group 1'...** Navigate to your PSoC™ Creator project folder and select `main_cm0p.c`, `cy_ipc_config.c`, and all other non-system `.c` and assembler files needed for your project, as Figure 19 shows. You do not have to add any `.h` files, startup, or system `.c`, or assembler files. Click **Add**; the files are added to the source group in the µVision project. Click **Close**.

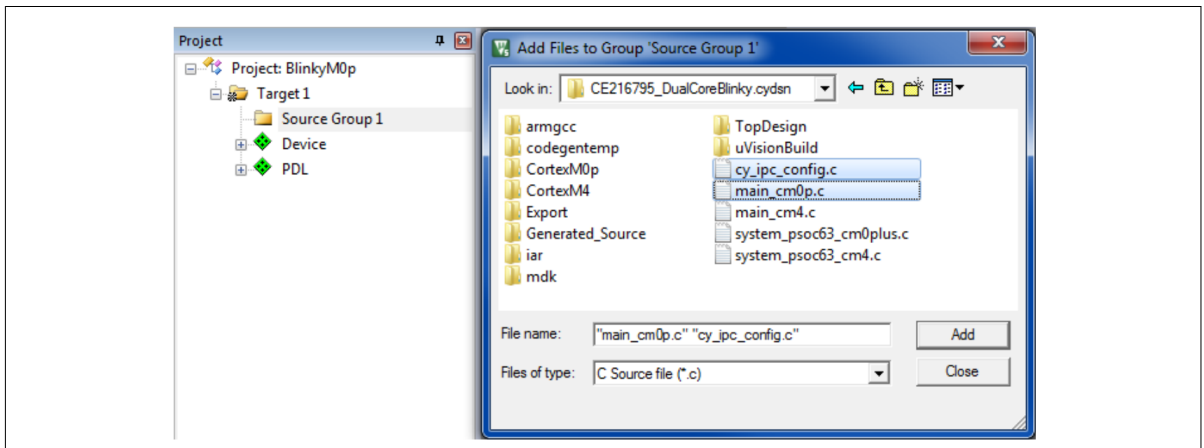

Figure 19 Add PSoC™ Creator project C source files to the source group

Now that the project is created, you must set its options. Right-click **Target 1**, and select **Options for Target 'Target 1'...** Confirm in the **Target** tab that the device, CPU, IROM1, and IRAM1 are correct for your PSoC™ 6 MCU device, as Figure 20 shows. Updating other fields such as Xtal (MHz) and Operating system is optional

4 PSoC™ 6 MCU dual-core development

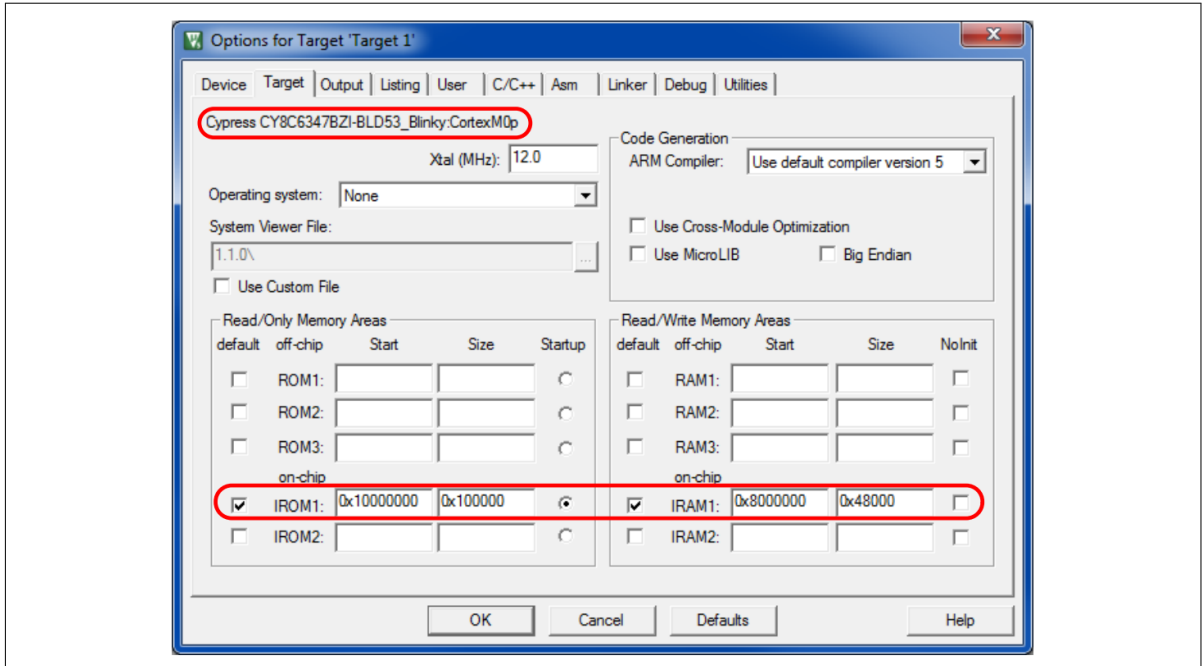

Figure 20 Project target options

In the **User** tab, verify that the correct post-build batch file from the pack is being called. Hover the cursor over the **User Command** field and confirm that `postbuildCortexM0p.bat` is called, as Figure 21 shows. Add other pre- and post-build batch files, and select other options, as needed

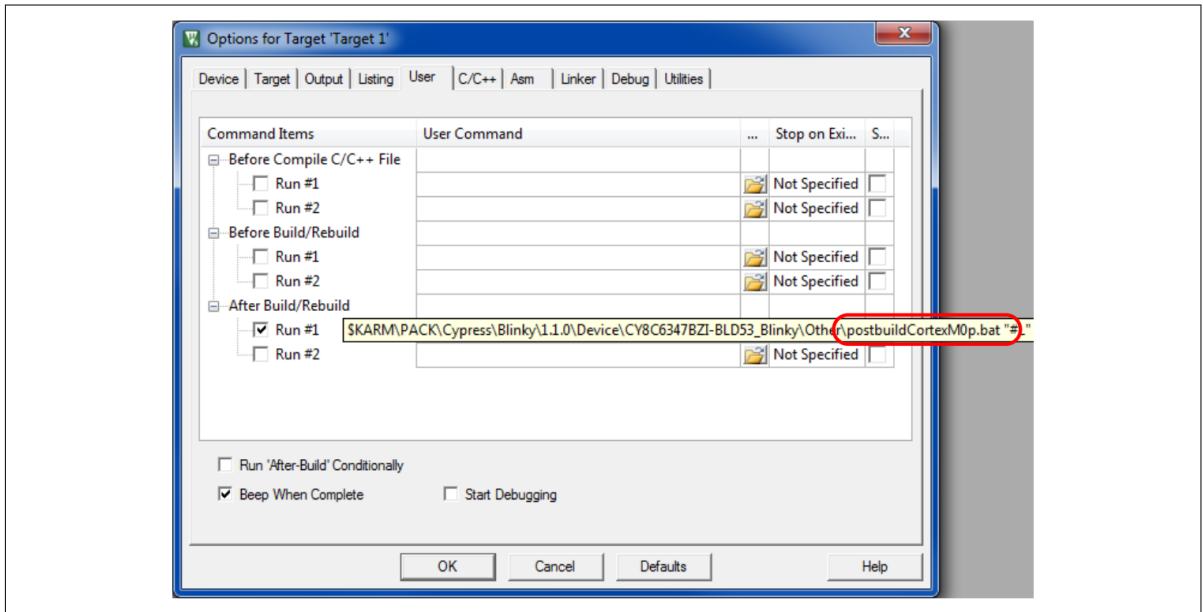

Figure 21 Project user options

Confirm in the **C/C++** tab that the **C99 mode** option is checked, as Figure 22 shows. (PDL is developed based on C99.) Add the PSoC™ Creator <project>.cydsn folder to the **Include Paths**; this provides a link to the .h files in the PSoC™ Creator project. Update other options and fields as needed

4 PSoC™ 6 MCU dual-core development

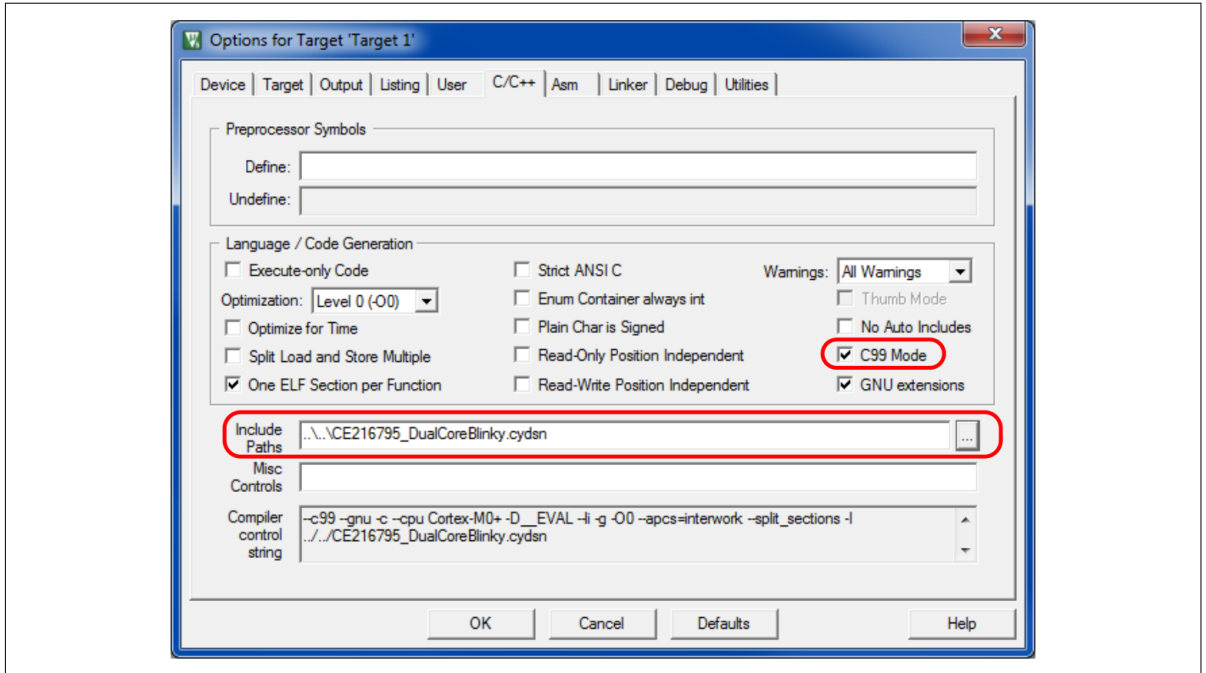

Figure 22 Project C/C++ options

Confirm in the **Linker** tab that the **R/O Base** and **R/W Base** fields are correct for your PSoC™ 6 MCU device, as [Figure 23](#) shows. Select the appropriate **Scatter File** from your PSoC™ Creator project folder

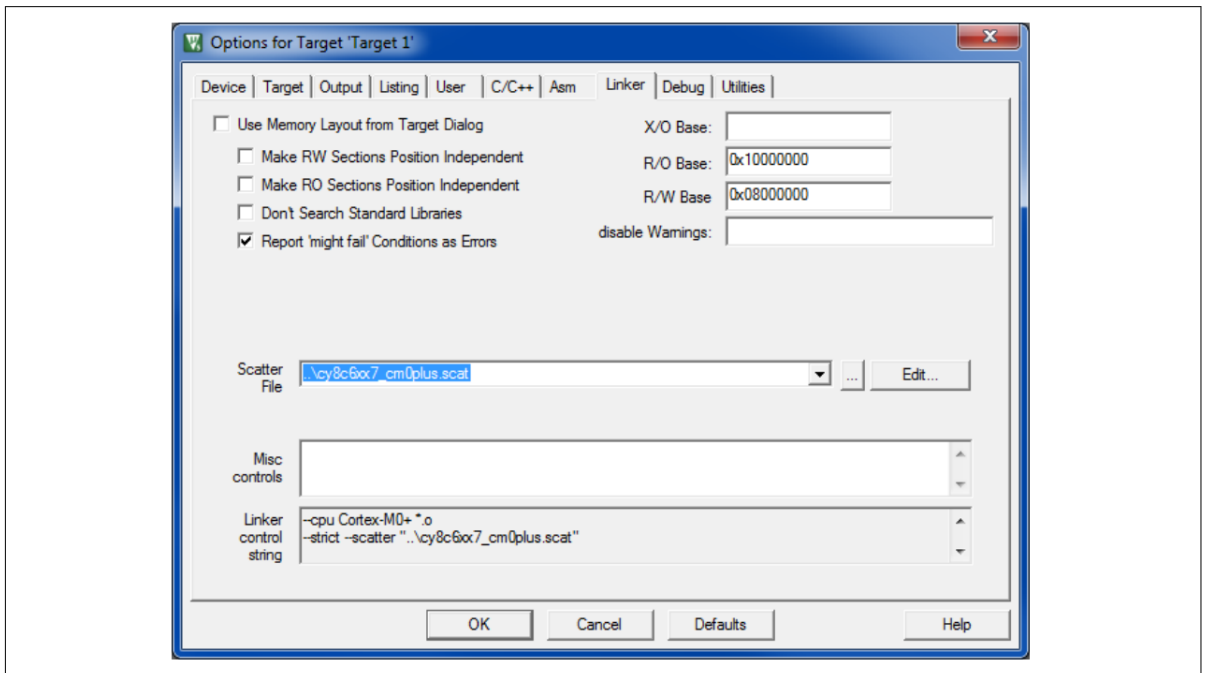

Figure 23 Project linker options

Connect the CY8CKIT-062-BLE USB port to your computer. Press the kit button SW3 to put KitProg2 into CMSIS-DAP mode; see the kit guide for details. This allows debugging without using any external probes
 In the **Debug** tab, select **Use CMSIS-DAP Debugger**, as [Figure 24](#) shows. Click **Settings**, select **KitProg2 CMSIS-DAP**, and confirm that all other settings are at the defaults shown. Click **OK** and go back to the Options dialog

4 PSoC™ 6 MCU dual-core development

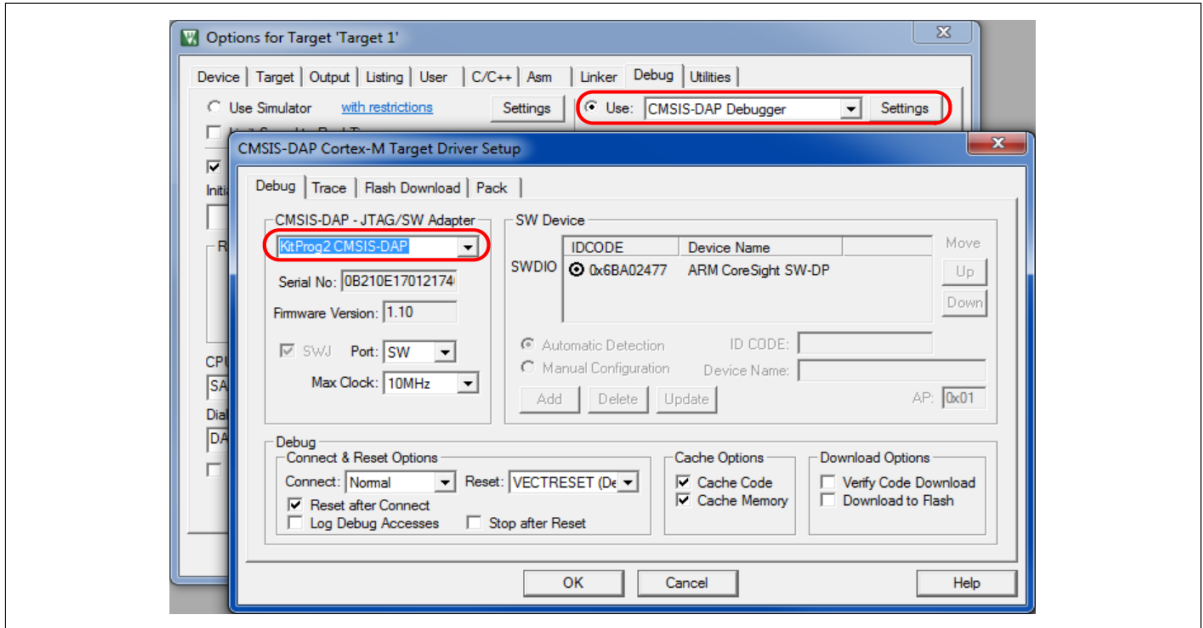

Figure 24 Project debug options

In the **Utilities** tab, confirm that Use Debug Driver is checked, and then uncheck **Update Target before Debugging**. Click **Settings**, and uncheck all **Download Function** boxes, as Figure 25 shows. Click **Do not Erase**. Click **OK** and go back to the **Options** dialog. A warning “Nothing to do ... “ is displayed; click **OK**. The application will be loaded by the CM4 project. Click **OK** to save and close the options settings

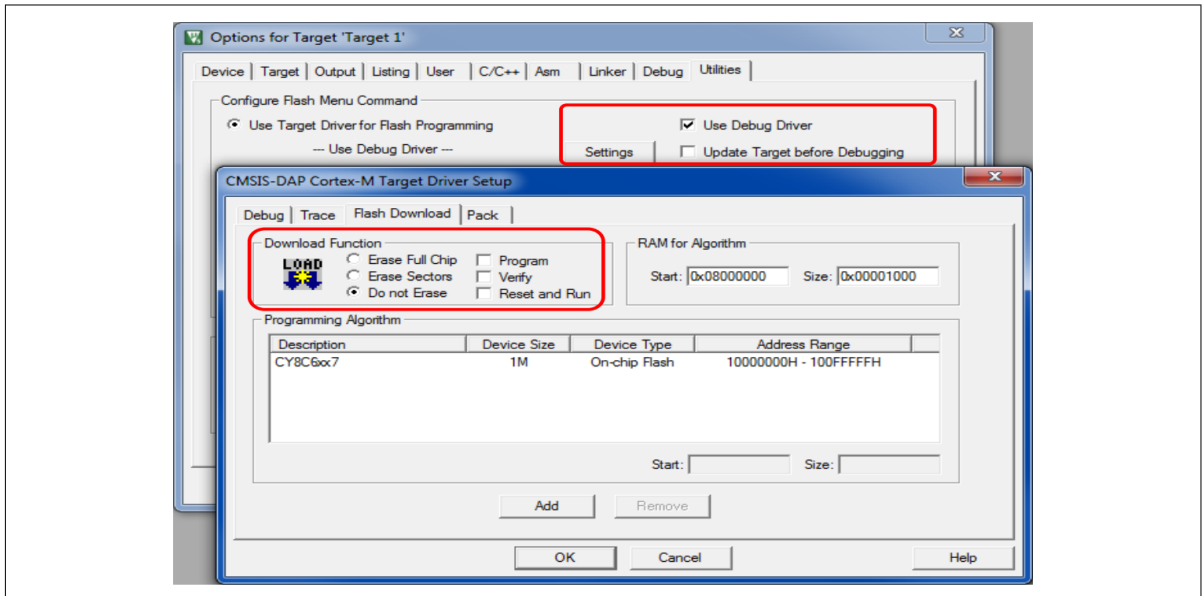

Figure 25 Project utilities options

Repeat the previous steps and create a second project for CM4.

Recommended: name the project based on the original PSoC™ Creator project name and the target CPU. For example, for the CE216795 dual-core blinky project, create μVision project BlinkyM4p; see Figure 14. Configure the project in the same manner as the CM0+ project, with the following differences:

- The CM4 project must be in the same folder as the CM0+ project; in this case, μVisionBuild. See Figure 14
- Select the CM4 CPU from the previously installed pack; see Figure 15

4 PSoC™ 6 MCU dual-core development

- Navigate to your PSoC™ Creator project folder and select `main_cm4.c`, `cy_ipc_config.c`, and all other non-system `.c` and assembler files needed for your project, as [Figure 19](#) shows. You do not have to add any `.h` files, startup, system `.c`, or assembler files
- In the **Options** dialog, **Output** tab, click **Select Folder for Objects...**, and select the `ObjectsM4` folder that you created; see [Figure 13](#)
- In the **Options** dialog, **C/C++** tab, add `--fpu=fpv4-sp` to **Misc Controls**; see [Figure 22](#)
- In the **Options** dialog, **Linker** tab, select the “`cm4_dual1`” scatter file, as [Figure 26](#) shows. The CM4 project will contain code for both CPUs. Add `--fpu=fpv4-sp` to **Misc Controls**

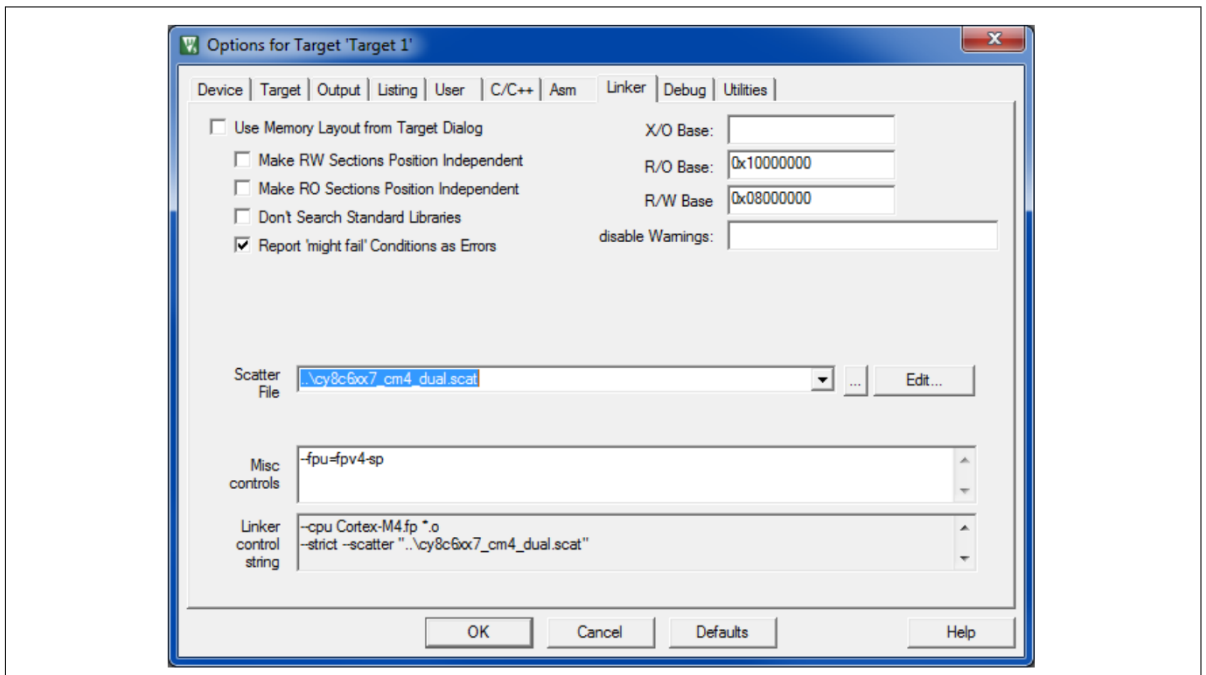

Figure 26 Linker options for CM4 project

- In the **Options** dialog, **Debug** tab, Target Driver Setup, select VECTRESET for the **Reset** option; see [Figure 24](#).
- In the **Options** dialog, **Utilities** tab, confirm that **Update Target before Debugging** is checked, as [Figure 27](#) shows. Set the RAM for Algorithm values as indicated. Checking **Reset and Run** is optional but convenient

4 PSoC™ 6 MCU dual-core development

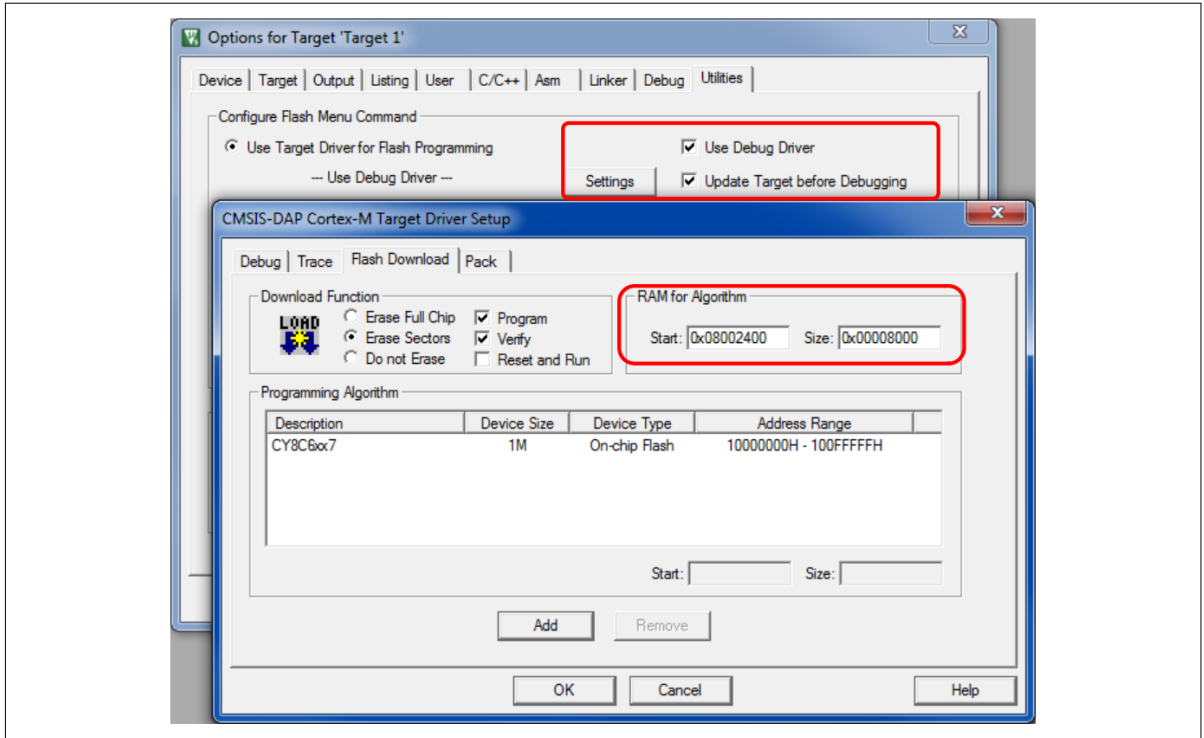

Figure 27 Utilities options for CM4 project

Finally, create a µVision workspace (**Project > New Multi-Project Workspace...**), named for example Blinky, in the uVisionBuild folder. Add the two created projects to that workspace. The created workspace and projects, and the corresponding files, should be similar to Figure 28.

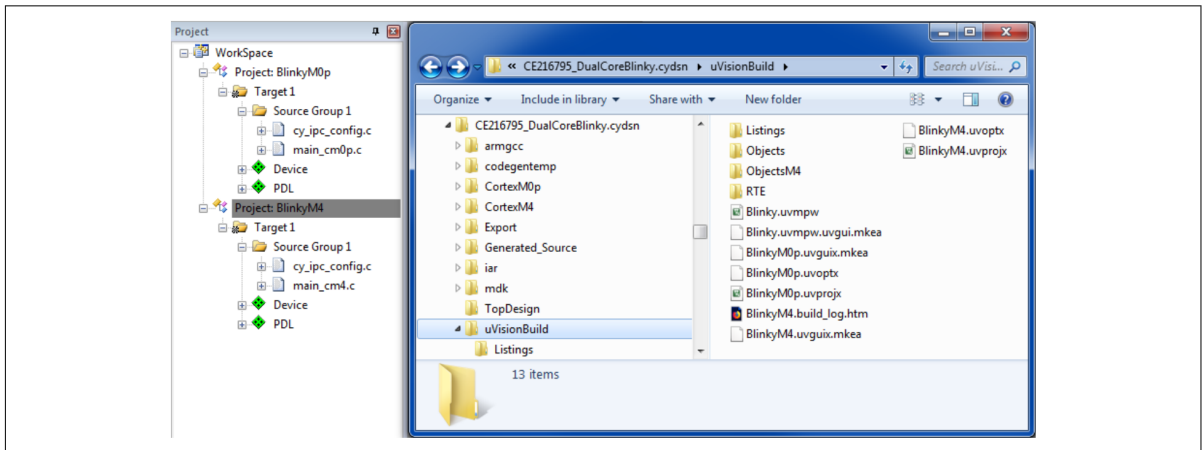

Figure 28 Resultant µVision project window and project files

Build the projects in sequence; build the CM0+ project first. Note that µVision has a batch build feature to automate the process. After building is successfully completed, right-click the BlinkyM4 project and set it as the active project. Then test your build options by (1) erasing flash (**Flash > Erase**), and (2) downloading the project (**Flash > Download**) and confirming correct operation. If you did not select Reset and Run (see Figure 27), you must press the kit reset button (RST / SW1) to start operation

Note: *If you change any code in the CM0+ project, you must rebuild both projects. Note that µVision has a batch build feature to automate the process.*

3. Debug µVision projects

4 PSoC™ 6 MCU dual-core development

Start debugging with the CM4 project – downloading the CM4 project installs code for both CPUs. Set the CM4 project as the active project, download it if needed, and click **Debug > Start/Stop Debug Session** to start debugging. The µVision window appears similar to Figure 29.

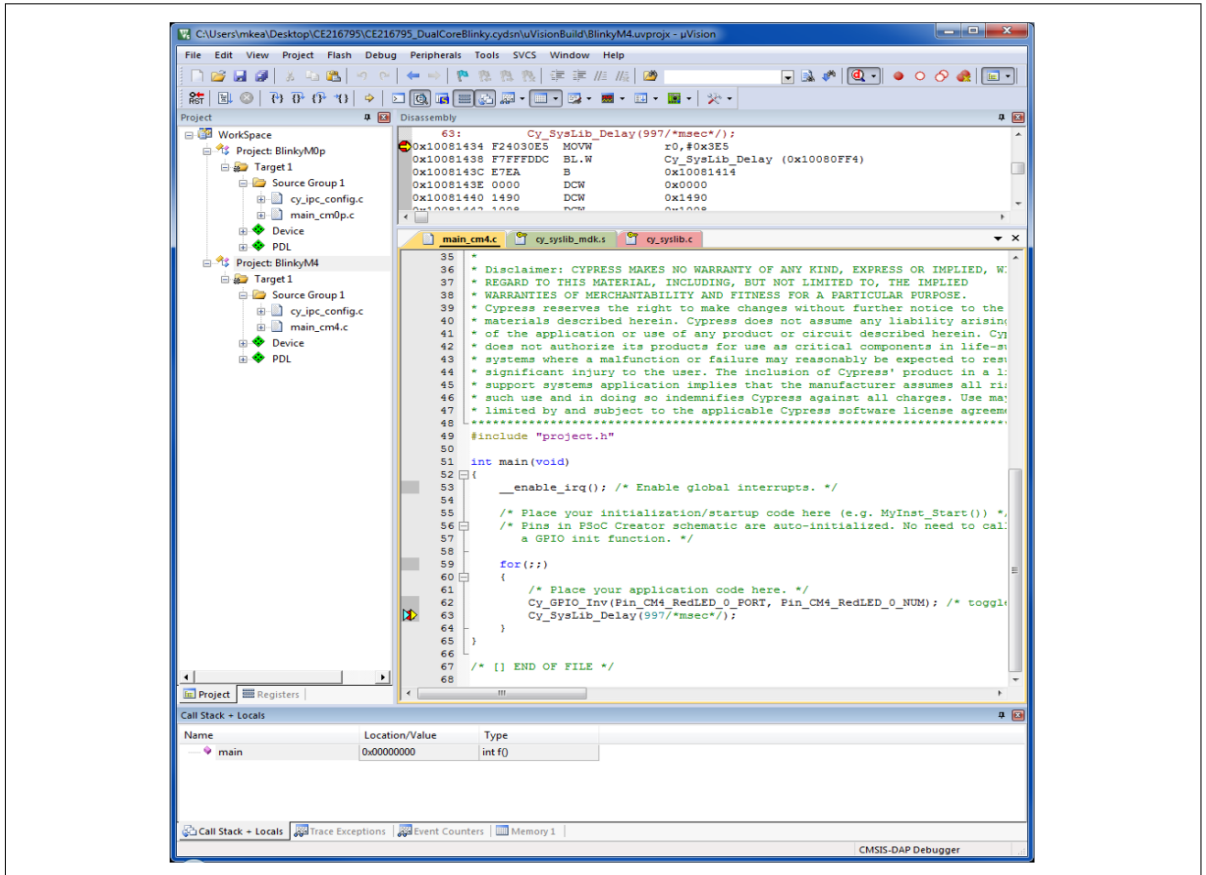

Figure 29 CM4 debug window

If you are running the CE216795 dual-core blinky project, set a breakpoint at line 63, Cy_SysLib_DeLay(). Then repeatedly click **Debug > Run**, and the red LED toggles on each stop at the breakpoint

Now open a second instance of µVision and load the same workspace. Both instances share the kit connection and the PSoC™ 6 MCU debug access port (DAP). Make the CM0+ project active, and start a debug session. Set a breakpoint at line 63, Cy_Syslib_DeLay(). Then repeatedly click **Debug > Run**, and the blue LED toggles on each stop at the breakpoint

Note: Executing the Cy_SysEnableCM4() function call at line 55 causes CM4 to start running again. Go to the CM4 window, click Debug > Stop, then Debug > Run. CM4 runs to the breakpoint again.

It helps to place the instance windows side by side on your desktop. The windows appear similar to Figure 30. Click in the appropriate window to perform a debug operation on the desired CPU. Note that breakpoints can be set separately for each CPU. You can read and update the same memory addresses from either window

4 PSoC™ 6 MCU dual-core development

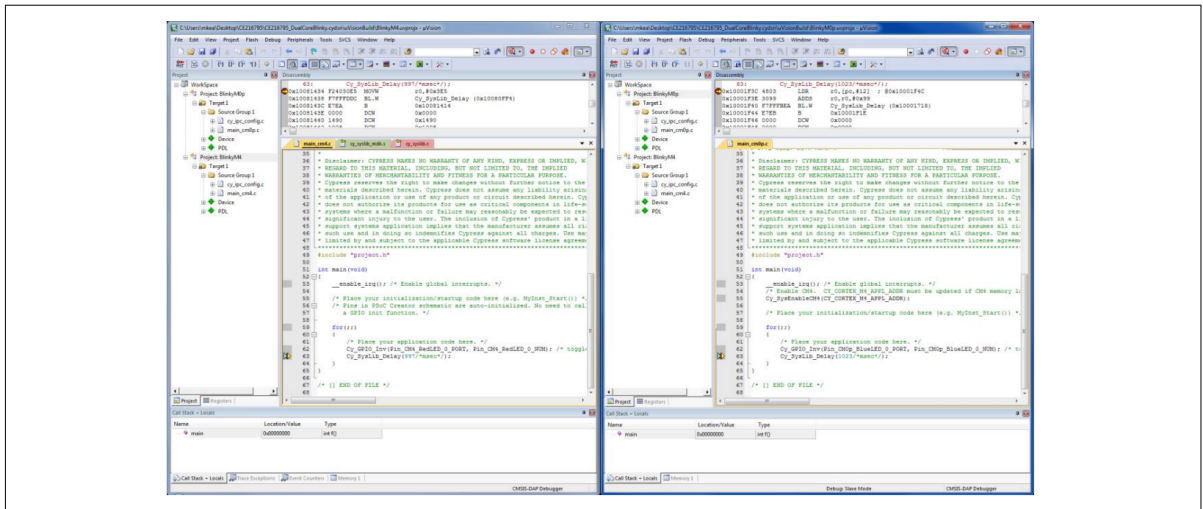

Figure 30 µVision dual-core debugging

4. Create IAR-EW projects

For IAR Embedded Workbench (IAR-EW), you must create two projects: one for each PSoC™ 6 MCU CPU: CM0+ and CM4. Do the following:

Note: *The IAR-EW project files should be created in your PSoC™ Creator <project>.cydsn folder. Do not create a separate folder within your PSoC™ Creator <project>.cydsn folder (this is different from the [µVision instructions](#)). **Recommended:** add a tag such as “IAR_” to each project and workspace file name, to distinguish the IAR-EW files from the PSoC™ Creator files in the same folder.*

Open IAR Embedded Workbench for ARM® 8.22 or later and create a new project (**Project > Create New Project...**). In the Create New Project dialog ([Figure 31](#)), confirm that the Tool chain is **Arm®**, select the **Empty project** template, then click **OK**.

4 PSoC™ 6 MCU dual-core development

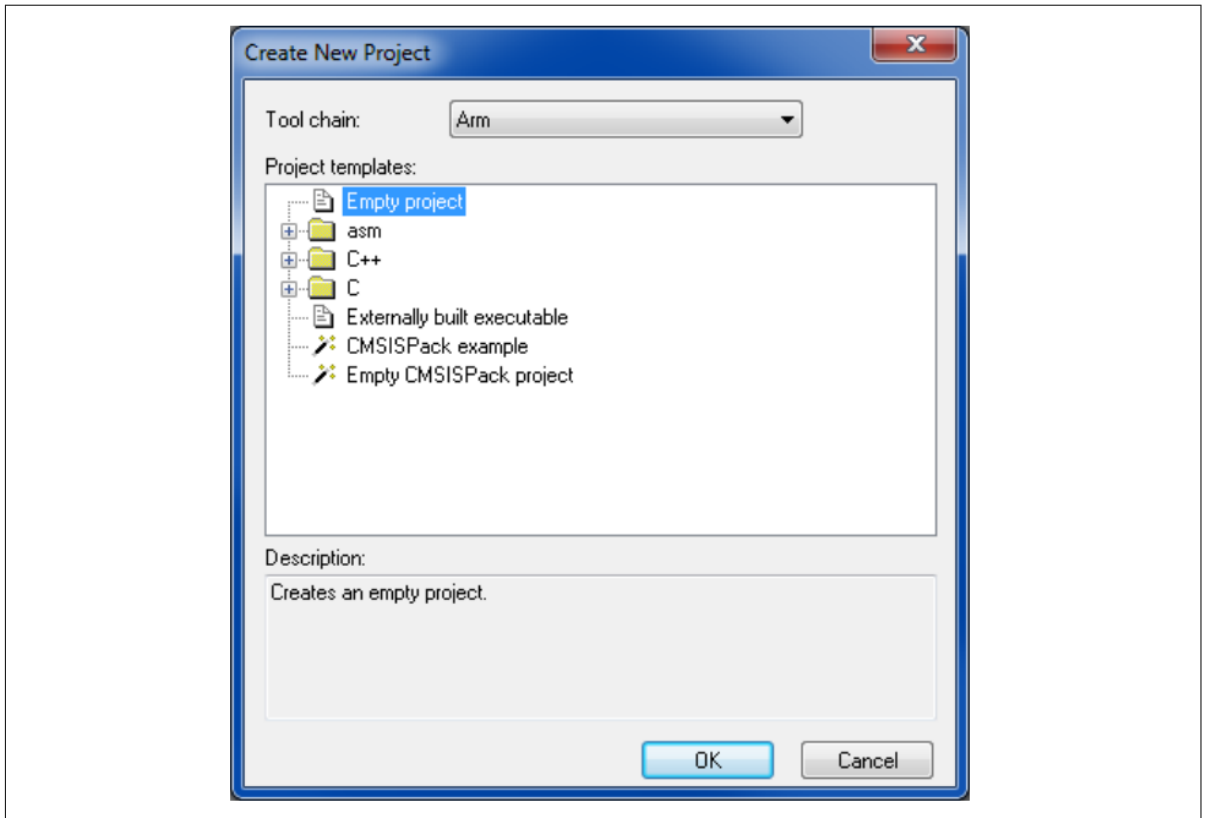

Figure 31 IAR Embedded Workbench create new project dialog

Recommended: in the Save As dialog (Figure 32), name the project based on the original PSoC™ Creator project name and the target CPU. For example, for the CE216795 dual-core blinky project, create a µVision project IAR_BlinkyM0p for the CM0+ CPU

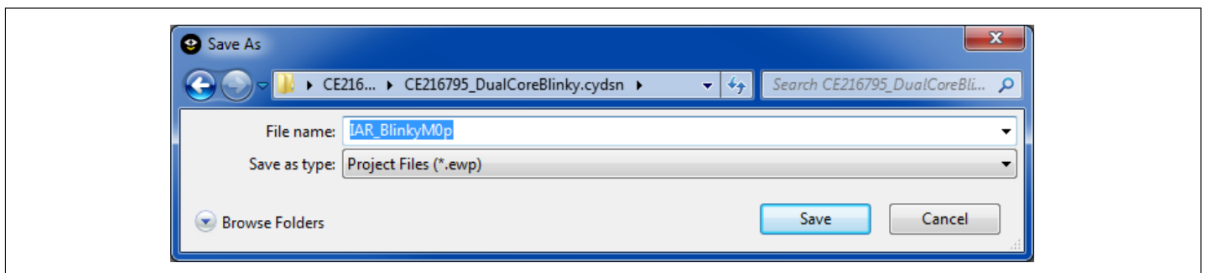

Figure 32 Create an IAR Embedded Workbench project for CM0+

Select **Tools > Options** and make sure that **Enable project connections** is checked. Click **OK**. Then select **Project > Add Project Connection...**. In the next dialog, select **Connect using IAR Project Connection**, and click **OK**. Then select the `...CortexM0p.ipcf` file, as Figure 33 shows. Click **OK**, and several folders and files are added to the project in the Workspace window

4 PSoC™ 6 MCU dual-core development

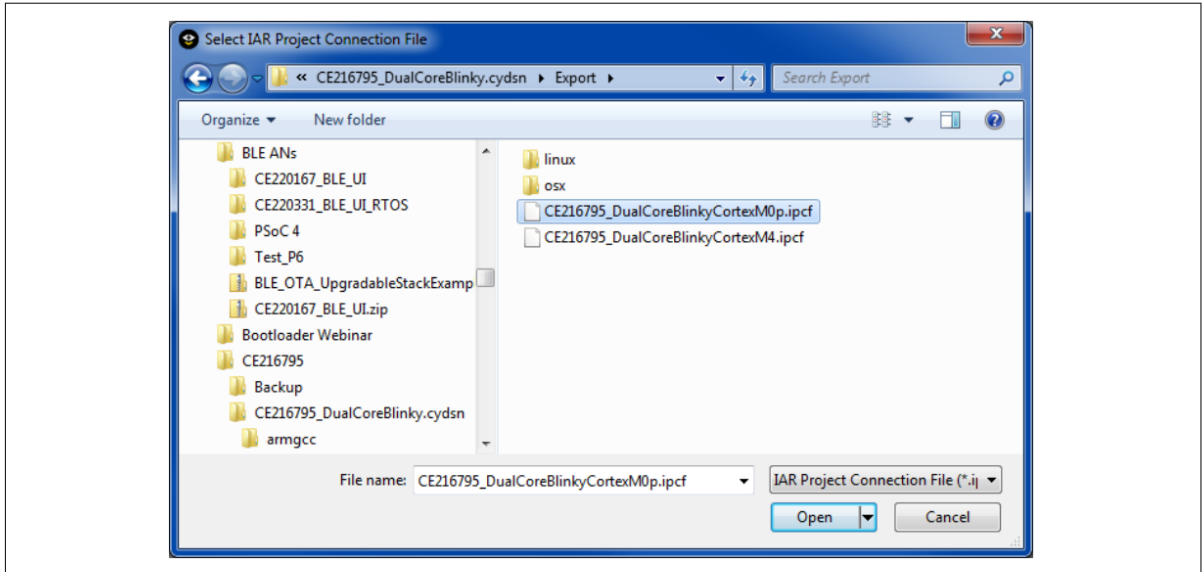

Figure 33 Select IAR project connection file from PSoC™ Creator project export folder

Now that the project is created, you must set its options. Right-click the project, and select **Options...**. Confirm in the Options dialog, **Build Actions** section that `postbuildCortexM0p.bat` is called, as [Figure 34](#) shows

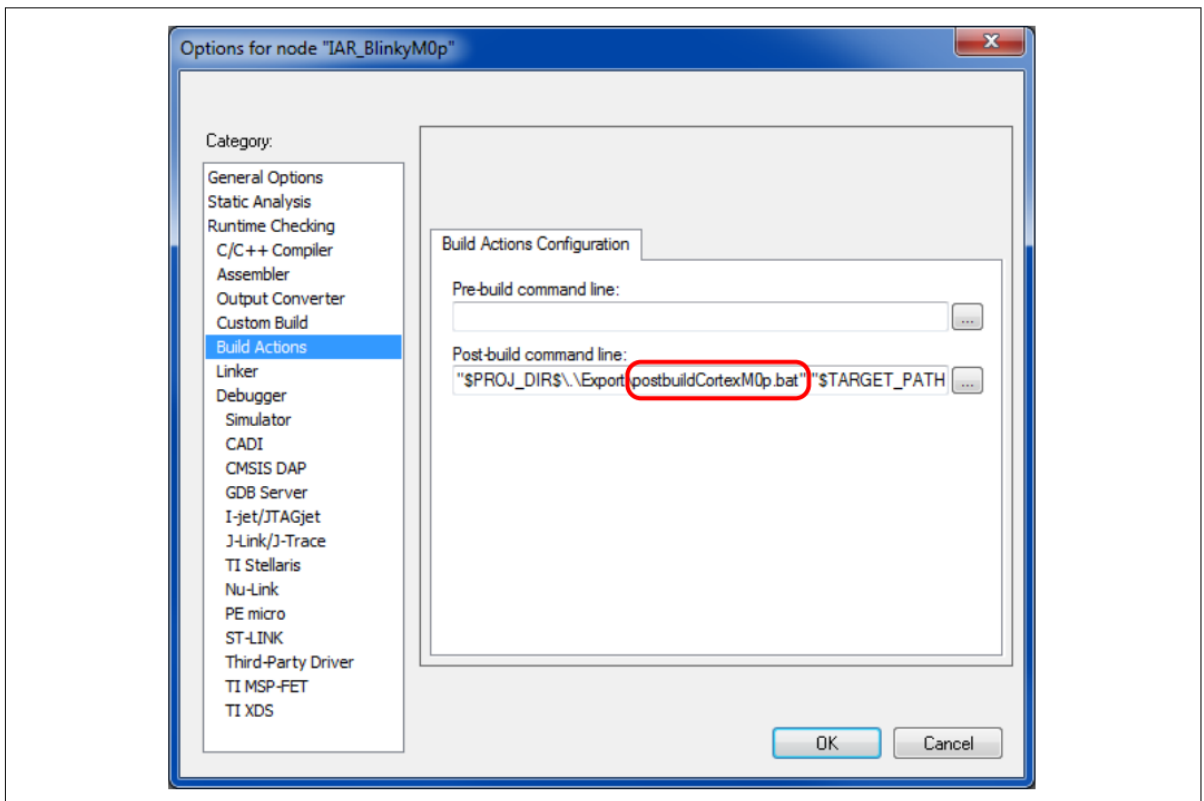

Figure 34 Select PSoC™ Creator post-build batch file

In the **Debugger** section, **Setup** tab, select the **CMSIS DAP** driver. In the **Download** tab, check **Suppress download**. In the **CMSIS DAP** section, **Setup** tab, set **Reset** to **Disabled (no reset)**. The application will be loaded by the CM4 project. In the **Interface** tab, select **SWD**. Click **OK**.

4 PSoC™ 6 MCU dual-core development

Repeat the previous steps and create a second project for CM4. **Recommended:** name the project based on the original PSoC™ Creator project name and the target CPU. For example, for the CE216795 dual-core blinky project, create IAR-EW project IAR_BlinkyM4; see Figure 32. Configure the project similar to the CM0+ project, with the following differences:

- The CM4 project must be in the same folder as the CM0+ project; in this case, your PSoC™ Creator <project>.cydsn folder. See Figure 32
- Select the ...CortexM4.ipcf file; see Figure 33
- In the **Options** dialog, **General Options** section, **Output** tab, change the output directories for object and list files, as Figure 35 shows. Do not change the executables/libraries output folder

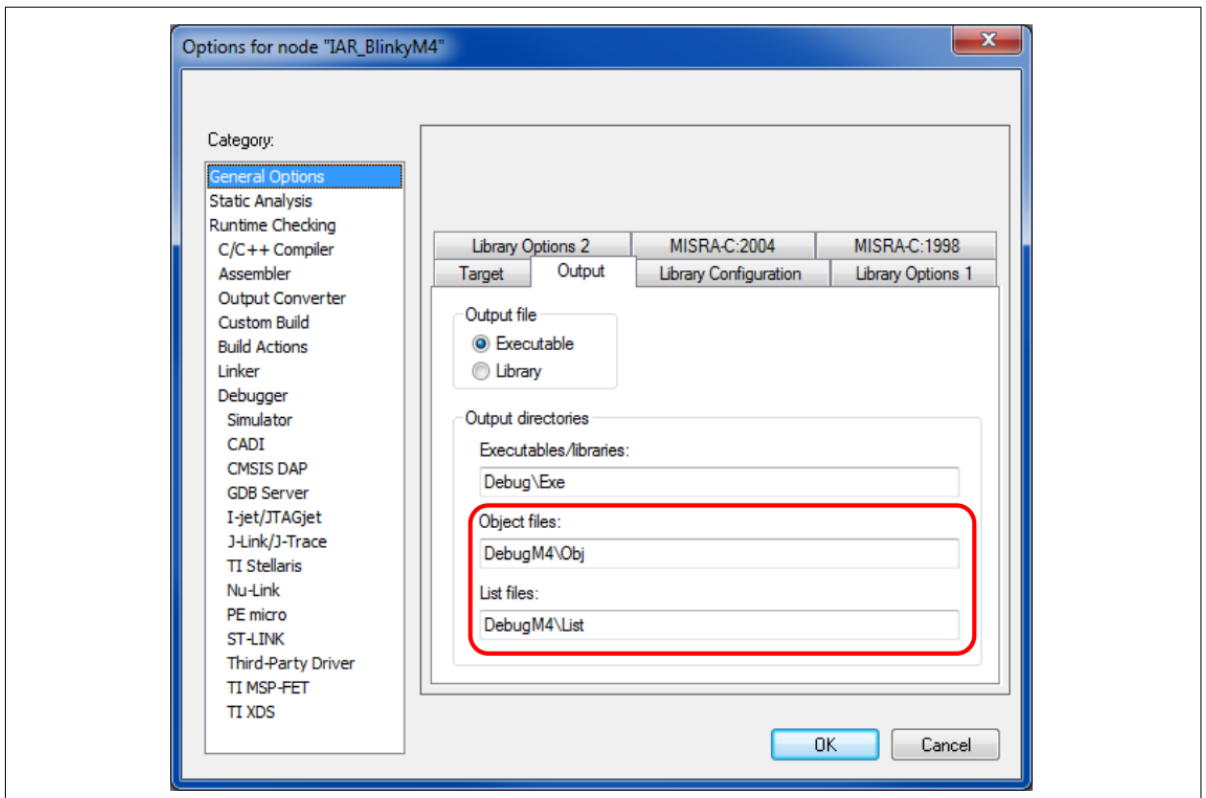

Figure 35 Unique output folders for CM4 project

- In the **Build Actions** section, confirm that postbuildCortexM4.bat is called, see Figure 34
- In the **Debugger** section, **Setup** tab, select the **CMSIS DAP** driver. In the **CMSIS DAP** section, **Setup** tab, confirm that **Reset** is set to **System (default)**. In the **Interface** tab, select **SWD**. Click **OK**

Save Workspace As dialog, create an IAR-EW workspace, named for example IAR_Blinky, in your PSoC™ Creator <project>.cydsn folder. The created workspace and projects, and the corresponding files, should be similar to Figure 36. The files and folders generated by IAR-EW are highlighted

4 PSoC™ 6 MCU dual-core development

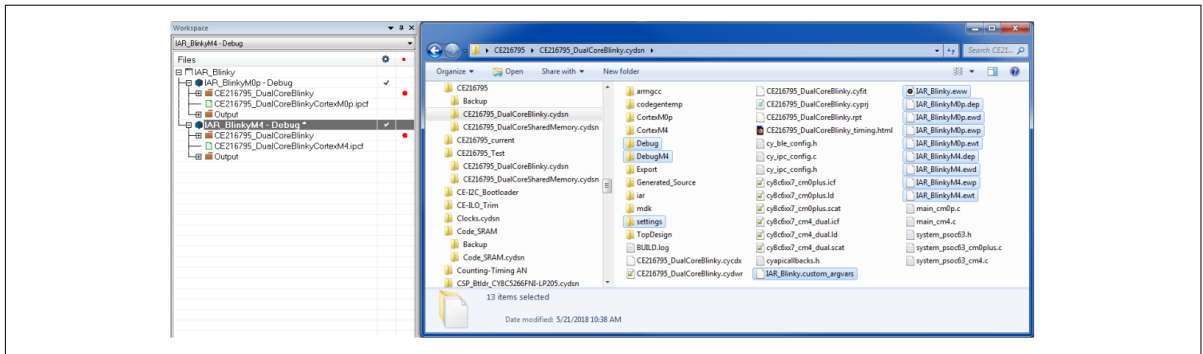

Figure 36 Resultant IAR Embedded Workbench project window and project files

Connect the CY8CKIT-062-BLE USB port to your computer. Press kit button SW3 to put KitProg2 into CMSIS-DAP mode; see the kit guide for details. This allows debugging without using any external debug probes

Build the projects in sequence; build the CM0+ project first. Note that IAR-EW has a batch build feature to automate the process. After building is successfully completed, right-click the BlinkyM4 project and set it as the active project. Then confirm that your build options are correct, by (1) erasing flash (**Project > Download > Erase memory**), and (2) downloading the project (**Project > Download > Download active application**) and confirming correct operation. After downloading, press the kit reset button (RST / SW1) to start operation

Note: When erasing flash, you typically only need to erase PSoC™ 6 MCU application flash (0x1000 0000 – 0x100F FFFF), as Figure 37 shows.

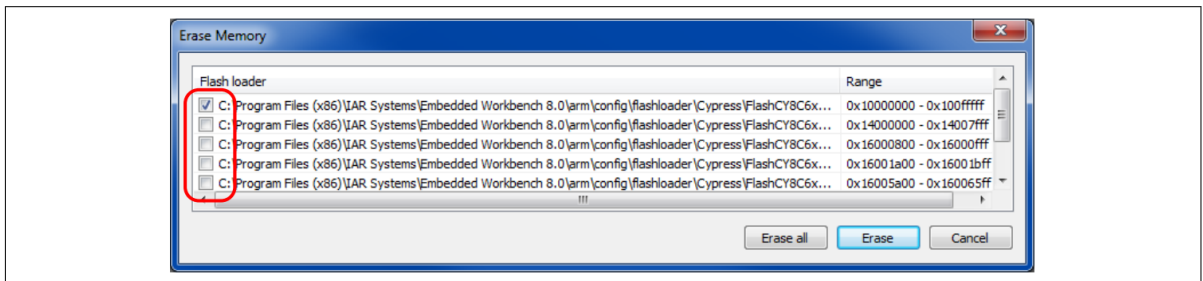

Figure 37 IAR Embedded Workbench erase memory dialog for PSoC™ 6 MCU

Note: If you change any code in the CM0+ project, you must rebuild both projects. Note that IAR-EW has a batch build feature to automate the process.

5. Debug IAR-EW projects

Reopen the options for the CM4 project, and go to the **Debugger** section, **Multicore** folder. PSoC™ 6 MCU has different cores, for example, CM0+ and CM4, which is referred to as "asymmetric multicore". Therefore, fill in the fields in the **Asymmetric multicore** section as Figure 38 shows. Checking **Enable multicore master mode** makes the CM4 CPU the master for download and debugging purposes. Do not change the **Port**.

4 PSoC™ 6 MCU dual-core development

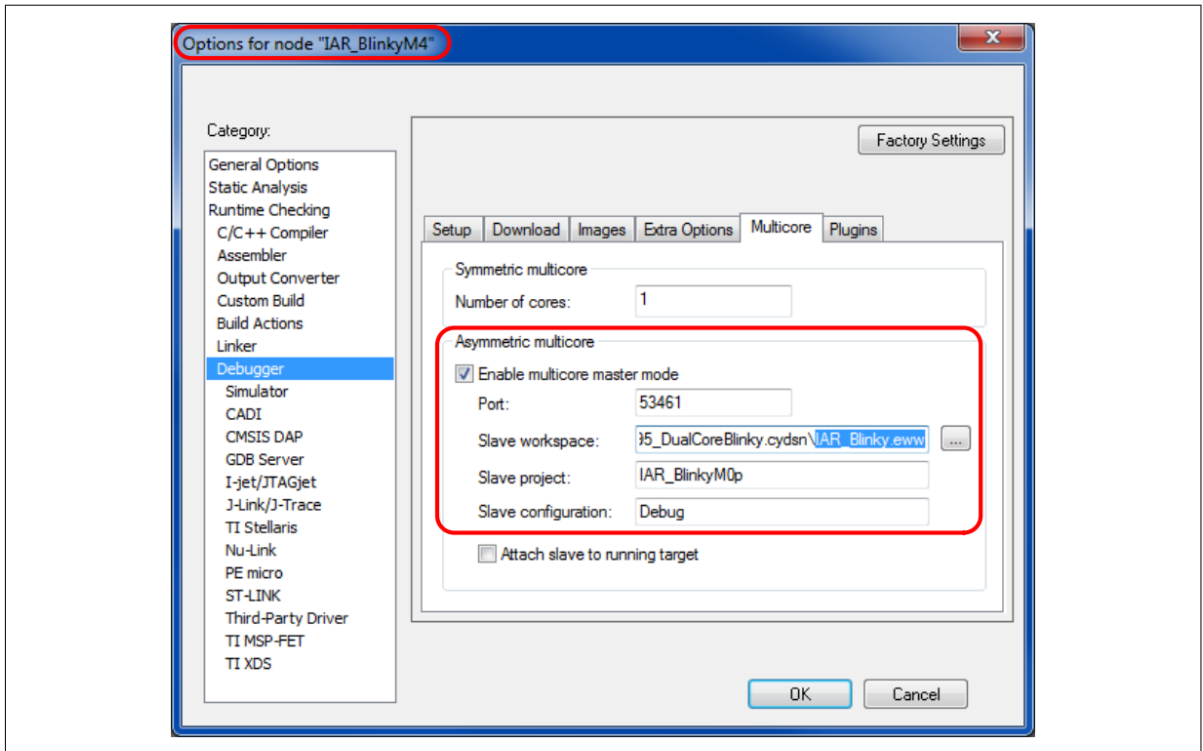

Figure 38 Set up multicore debugging

Select **File > Save All** to save the project options changes. Then start debugging by selecting either **Project > Download and Debug** or **Project > Debug without Downloading**. A second (slave) instance of IAR Embedded Workbench is automatically opened for the CM0+ project. Both instances share the kit connection and the PSoC™ 6 MCU debug access port (DAP).

In the slave instance, set a breakpoint at line 63, `cy_SysLib_DeLAY()`. Then repeatedly click **Debug > Go**, and the blue LED toggles on each stop at the breakpoint

Click anywhere in the CM4 instance window and repeat the process. The red LED toggles on each stop at the breakpoint

It helps to place the instance windows side by side on your desktop. The windows appear like Figure 39. Click in the appropriate window to perform a debug operation on the desired CPU. Note that breakpoints can be set separately for each CPU. You can read and update the same memory addresses from either window

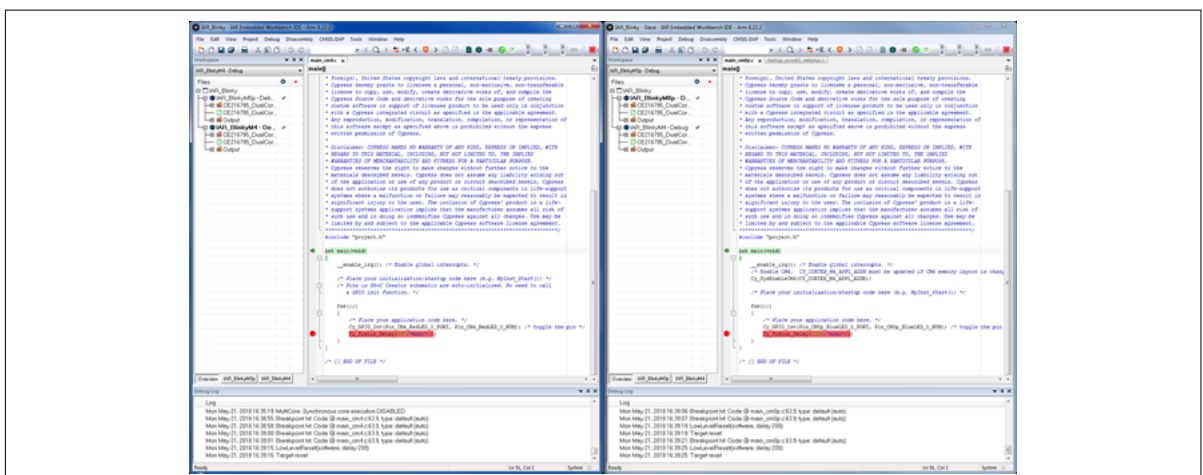

Figure 39 IAR Embedded Workbench dual-CPU debugging

4 PSoC™ 6 MCU dual-core development

You can stop debugging in either window; debugging is ended for both CPUs. Press the kit reset button (RST/SW1) to restart kit operation

4 PSoC™ 6 MCU dual-core development

4.8 Connectivity application design considerations

ModusToolbox™ Connectivity, Wi-Fi, and Bluetooth® middleware libraries are made available through [GitHub](#). These libraries can be used for developing wireless IoT applications using PSoC 6™ MCUs and Infineon’s AIROC™ Wi-Fi and Bluetooth® combo devices. The user has the option of choosing either the Arm® CM0+ or CM4 core for executing the connectivity application along with its necessary middleware and driver libraries. Throughput (data transmission speed in bits per second) and PSoC™ 6 MCU power consumption (in milliampere/microampere) are important factors to consider when deciding the core for the connectivity application. The related performance requirements play a crucial role in determining the optimal core to be used for the connectivity application. The following sections show the results of those analyses.

4.8.1 Throughput analysis

The below figure shows the test setup used for measuring the throughput. The [CY8CPROTO-062S2-43439](#) kit is set up to run an [iperf](#) application in TCP client mode. The kit is connected to a PC running ModusToolbox™ via USB for programming and iperf log viewing. The KitProg3 USB-UART bridge is used with Tera Term software for log viewing. The PC also runs an iperf application in server mode. Both the kit and PC are connected to the same Wi-Fi router. The test setup is at a normal ambient setting meaning not inside a temperature/anechoic chamber.

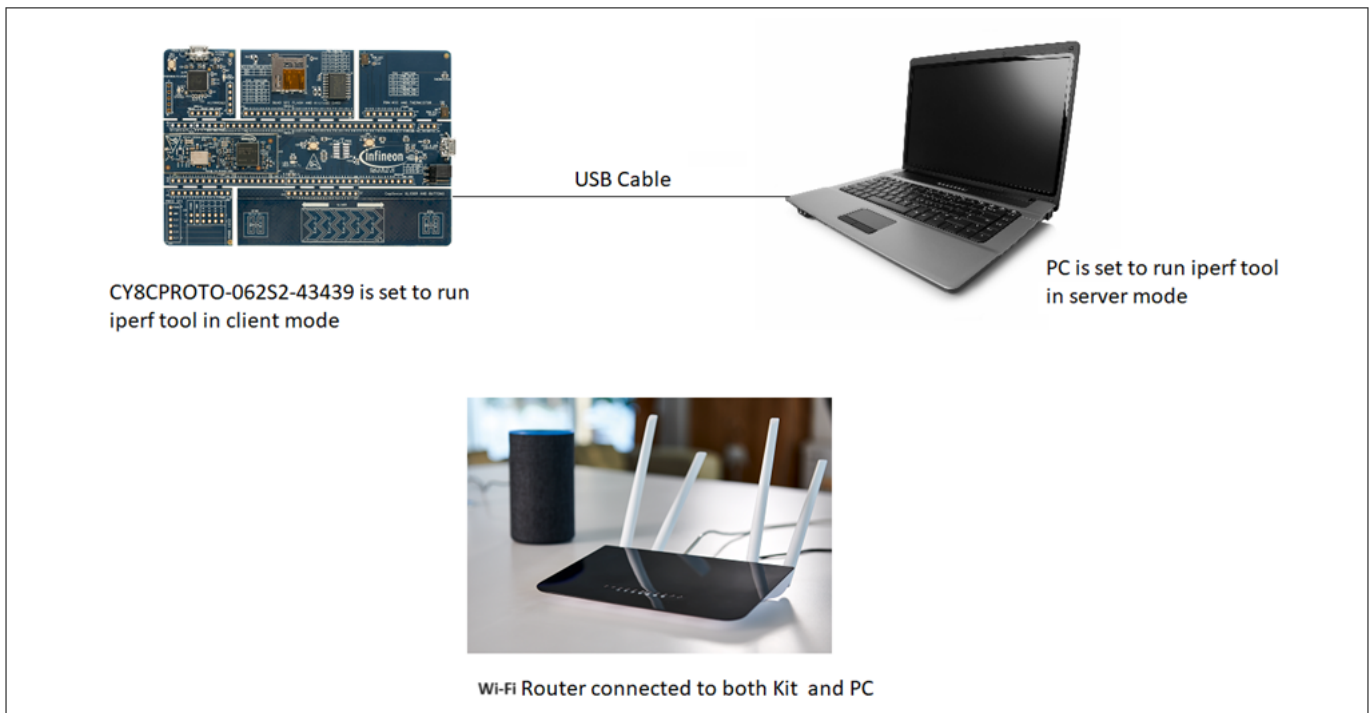

Figure 40 Throughput measurement setup

The following table shows the achieved throughput with the default BSP settings with System Idle Power Mode set to Active, in a home Wi-Fi network:

Table 1 Throughput details

Scenario	Throughput (Megabits per second, Mbps)
CM0+ core sleep, CM4 core active @100 MHz	Peak = 21.9, Typical = 21.2
CM4 core sleep, CM0+ core active @100 MHz	Peak = 16.2, Typical = 15.9

Below are the screenshots of the iperf measurement output from both the kit and the PC.

4 PSoC™ 6 MCU dual-core development

CM4 execution:

```

> iperf -c 192.168.1.11 -p 50007 -t 20 -i 1
>
-----
Client connecting to 192.168.1.11, TCP port 50007
TCP window size: 29.3 KByte (default)
-----
[ ID] Interval      Transfer      Bandwidth
[  0] 0.0- 1.0 sec  2.58 MBytes  21.7 Mbits/sec
[  0] 1.0- 2.0 sec  2.46 MBytes  20.6 Mbits/sec
[  0] 2.0- 3.0 sec  2.40 MBytes  20.1 Mbits/sec
[  0] 3.0- 4.0 sec  2.56 MBytes  21.5 Mbits/sec
[  0] 4.0- 5.0 sec  2.53 MBytes  21.3 Mbits/sec
[  0] 5.0- 6.0 sec  2.55 MBytes  21.4 Mbits/sec
[  0] 6.0- 7.0 sec  2.48 MBytes  20.8 Mbits/sec
[  0] 7.0- 8.0 sec  2.47 MBytes  20.7 Mbits/sec
[  0] 8.0- 9.0 sec  2.40 MBytes  20.1 Mbits/sec
[  0] 9.0-10.0 sec  2.57 MBytes  21.6 Mbits/sec
[  0] 10.0-11.0 sec 2.54 MBytes  21.3 Mbits/sec
[  0] 11.0-12.0 sec 2.54 MBytes  21.3 Mbits/sec
[  0] 12.0-13.0 sec 2.51 MBytes  21.1 Mbits/sec
[  0] 13.0-14.0 sec 2.56 MBytes  21.5 Mbits/sec
[  0] 14.0-15.0 sec 2.59 MBytes  21.7 Mbits/sec
[  0] 15.0-16.0 sec 2.52 MBytes  21.1 Mbits/sec
[  0] 16.0-17.0 sec 2.61 MBytes  21.9 Mbits/sec
[  0] 17.0-18.0 sec 2.52 MBytes  21.1 Mbits/sec
[  0] 18.0-19.0 sec 2.54 MBytes  21.3 Mbits/sec
[  0] 19.0-20.0 sec 2.58 MBytes  21.6 Mbits/sec
[  0] 0.0-20.0 sec 50.5 MBytes  21.2 Mbits/sec
    
```

Figure 41 Throughput observed on the kit with CM4 core

```

PS C:\DATA\Apps\iperf> .\iperf-win-isoach-fix.exe -s -w 64k -p 50007
-----
Server listening on TCP port 50007
TCP window size: 62.5 KByte
-----
[  1] local 192.168.1.11 port 50007 connected with 192.168.1.7 port 52437
[ ID] Interval      Transfer      Bandwidth
[  1] 0.00-19.90 sec  49.7 MBytes  20.9 Mbits/sec
[  2] local 192.168.1.11 port 50007 connected with 192.168.1.7 port 52438
[ ID] Interval      Transfer      Bandwidth
[  2] 0.00-19.90 sec  50.4 MBytes  21.3 Mbits/sec
[  3] local 192.168.1.11 port 50007 connected with 192.168.1.7 port 52439
[ ID] Interval      Transfer      Bandwidth
[  3] 0.00-19.88 sec  50.6 MBytes  21.3 Mbits/sec
    
```

Figure 42 Throughput observed on the PC with app running on CM4 core

4 PSoC™ 6 MCU dual-core development

CM0+ execution

```

> iperf -c 192.168.1.11 -p 50007 -t 20 -i 1
>
-----
Client connecting to 192.168.1.11, TCP port 50007
TCP window size: 29.3 KByte (default)
-----
[ ID] Interval      Transfer      Bandwidth
[  0] 0.0- 1.0 sec  1.86 MBytes  15.6 Mbits/sec
[  0] 1.0- 2.0 sec  1.91 MBytes  16.1 Mbits/sec
[  0] 2.0- 3.0 sec  1.93 MBytes  16.2 Mbits/sec
[  0] 3.0- 4.0 sec  1.87 MBytes  15.6 Mbits/sec
[  0] 4.0- 5.0 sec  1.91 MBytes  16.0 Mbits/sec
[  0] 5.0- 6.0 sec  1.92 MBytes  16.1 Mbits/sec
[  0] 6.0- 7.0 sec  1.91 MBytes  16.1 Mbits/sec
[  0] 7.0- 8.0 sec  1.90 MBytes  15.9 Mbits/sec
[  0] 8.0- 9.0 sec  1.91 MBytes  16.1 Mbits/sec
[  0] 9.0-10.0 sec  1.92 MBytes  16.1 Mbits/sec
[  0] 10.0-11.0 sec 1.88 MBytes  15.7 Mbits/sec
[  0] 11.0-12.0 sec 1.90 MBytes  16.0 Mbits/sec
[  0] 12.0-13.0 sec 1.90 MBytes  16.0 Mbits/sec
[  0] 13.0-14.0 sec 1.90 MBytes  15.9 Mbits/sec
[  0] 14.0-15.0 sec 1.88 MBytes  15.8 Mbits/sec
[  0] 15.0-16.0 sec 1.91 MBytes  16.0 Mbits/sec
[  0] 16.0-17.0 sec 1.91 MBytes  16.0 Mbits/sec
[  0] 17.0-18.0 sec 1.92 MBytes  16.1 Mbits/sec
[  0] 18.0-19.0 sec 1.90 MBytes  15.9 Mbits/sec
[  0] 19.0-20.0 sec 1.81 MBytes  15.2 Mbits/sec
[  0] 0.0-20.0 sec 38.0 MBytes  15.9 Mbits/sec
    
```

Figure 43 Throughput observed on the kit with CM0+ core

```

PS C:\DATA\Apps\iperf> .\iperf-win-isoach-fix.exe -s -w 64k -p 50007
-----
Server listening on TCP port 50007
TCP window size: 62.5 KByte
-----
[  1] local 192.168.1.11 port 50007 connected with 192.168.1.7 port 52432
[ ID] Interval      Transfer      Bandwidth
[  1] 0.00-19.91 sec 38.0 MBytes  16.0 Mbits/sec
[  2] local 192.168.1.11 port 50007 connected with 192.168.1.7 port 52433
[ ID] Interval      Transfer      Bandwidth
[  2] 0.00-19.91 sec 37.5 MBytes  15.8 Mbits/sec
[  3] local 192.168.1.11 port 50007 connected with 192.168.1.7 port 52434
[ ID] Interval      Transfer      Bandwidth
[  3] 0.00-19.91 sec 37.8 MBytes  15.9 Mbits/sec
    
```

Figure 44 Throughput observed on the PC with app running on CM0+ core

The above table and images clearly show that the CM4 core has approximately 5.7 Mbps higher throughput than the CM0+ core. So, we can conclude that running from CM4 generally results in higher throughput due to core architecture features compared to CM0+.

4 PSoC™ 6 MCU dual-core development

```
=====
LED turned ON
Acknowledgment sent to TCP server

CPU cycles consumed: 41767

=====
LED turned OFF
Acknowledgment sent to TCP server

CPU cycles consumed: 41905

=====
LED turned ON
Acknowledgment sent to TCP server

CPU cycles consumed: 41671

=====
LED turned OFF
Acknowledgment sent to TCP server

CPU cycles consumed: 41871
=====
```

Figure 45 CPU cycle consumed by the Wi-Fi task on CM core

A TCP client application, which periodically receives data bytes, consumes approximately 42k CPU cycles per transfer on the CM4 core, as shown in the image above. The same can be saved by moving the Wi-Fi stack and application code to the CM0+ core, which can be utilized for other process intense tasks.

4.8.2 Power consumption analysis

The below figure shows the test setup used for measuring the power consumption. [CY8CPROTO-062S2-43439](#) kit is set up to run the [mtb-example-wifi-wlan-lowpower](#) application in low-power mode is connected over USB cable to a PC running [ModusToolbox™](#) for programming the kit. Both the kit and PC are connected to the same Wi-Fi router. On the kit, current measurement points are then connected to a multimeter to measure the current consumption.

Note: *Minor kit rework is needed to measure the current on this board. Remove the resistor R65 and connect the multimeter probes between the P6_VDD and VTARG signals.*

4 PSoC™ 6 MCU dual-core development

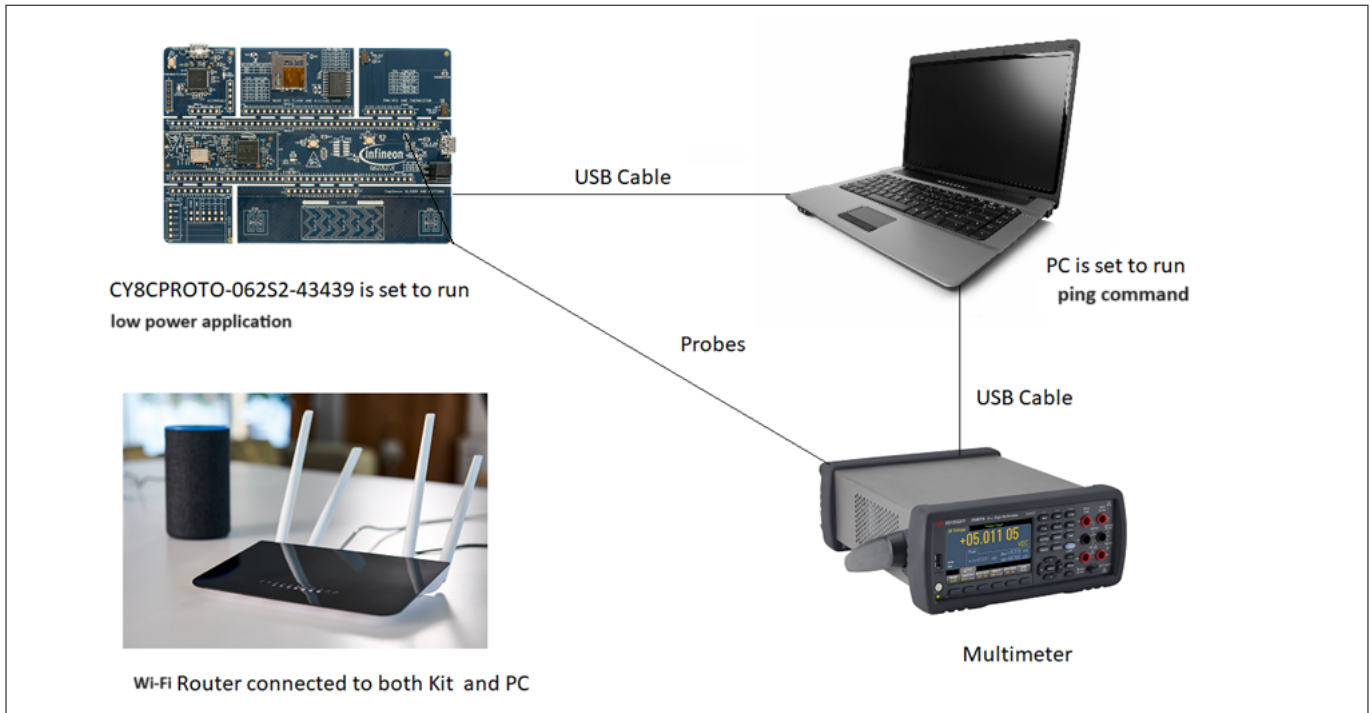

Figure 46 Current measurement setup

The following table shows the achieved throughput with the default BSP settings, for 10 ping commands:

Table 2 Current consumption details

Scenario	Current (mA)
CM0+ core sleep, CM4 core active @3.3 V	Peak = 3.42 mA, Average = 773 µA
CM4 core sleep, CM0+ core active @3.3 V	Peak = 2.58 mA, Average = 751 µA

The figures below show the current measurement obtained from a power analyzer.

4 PSoC™ 6 MCU dual-core development



Figure 47 Application execution on CM4



Figure 48 Application execution on CM0+

Table 2, Figure 47, and Figure 48 show that the peak current consumption is approximately 0.85 mA higher while running the application on the CM4 core compared to the CM0+ core. Please note that the application used in this example is designed to minimize power consumption by utilizing offload features such as packet filtering. As a result, there is only a slight difference in average current consumption between the cores. Therefore, we can conclude that running from CM4 generally results in higher current consumption due to core architecture features compared to CM0+.

4 PSoC™ 6 MCU dual-core development

4.8.3 Porting applications between cores

You can easily port [ModusToolbox™](#) connectivity applications developed by you from one core to another (For example, from CM4 to CM0+) by following the guidelines in [Infineon developer community](#) article [KBA236435](#). This porting may be needed at times to evaluate the tradeoffs of requirements from the application.

4.8.4 Virtual Connectivity Manager

If you need to run connectivity applications on both the CM4 and CM0+ cores at the same time (For example, two MQTT clients), ModusToolbox™ offers a VCM library for sharing the connectivity libraries between the cores. This library uses the IPC mechanism to call connectivity-related APIs from a secondary connectivity core to a primary connectivity core. This way the application design becomes simple and save memory as there is no need to link the connectivity libraries on the binaries for both the cores. The [mtb-example-wifi-dual-core-virtual-mqtt-client](#) code example demonstrates the features of this library.

5 Summary

5 Summary

This application note has shown how to use and optimize your firmware and hardware designs for the dual-core feature in PSoC™ 6 MCUs.

Another way to optimize your PSoC™ 6 MCU design is based on the fact that PSoC™ devices are designed to be flexible and enable you to build custom functions in programmable analog and digital blocks. For example, PSoC™ 6 MCU has the following peripherals that can act as “co-processors”:

- **DMA controllers** Note that the most common CPU assembler instructions output by C compilers are MOV, LDR, and STR, which implies that the CPU spends a lot of cycles just moving bytes around. Let the DMA controllers do that instead

Note: *PSoC™ 6 MCU DMA controllers have an extensive set of features that enable you to construct complex data transfer and control systems that are independent of the CPUs. Software support of these features is provided in the ModusToolbox™ software Device Configurator, a PSoC™ Creator DMA Component, and an API in the PDL. For more information, see the Device Configurator Help Guide, the DMA Component datasheet, or the PDL documentation.*

- **Crypto block** This block offers hardware acceleration for symmetric and asymmetric cryptographic methods (AES, 3DES, RSA, and ECC) and hash functions (SHA-512, SHA-256). It also has a true random number generator (TRNG) function. Software support for these features is provided by an API in the PDL; see the PDL documentation. The Infineon HAL does not have a crypto driver at the moment
- **Universal Digital Blocks (UDBs)** There are as many as 12 UDBs, and each UDB has an 8-bit datapath that can add, subtract, and do bitwise operations, shifts, and cyclic redundancy check (CRC). Datapaths can be chained for word-wide calculations. Consider offloading CPU calculations to the datapaths. At the moment, only PSoC™ Creator supports UDBs. ModusToolbox™ software does not have any support for UDBs
- UDBs also have programmable logic devices (PLDs) which can be used to build state machines; see for example the Lookup Table (LUT) Component datasheet. LUTs can be an effective hardware-based alternative to programming state machines in the CPU, for example by using C switch/case statements. In addition, two GPIO ports include Smart I/O™, which can be used to perform Boolean operations directly on signals going to, and coming from, GPIO pins. The Infineon HAL does not have support for Smart I/O
- Other smart peripherals include serial communication blocks (SCB), counter/timer/PWM blocks (TCPWM), Bluetooth® Low Energy, I2S/PDM audio, programmable analog, and CAPSENSE™. Use these peripherals to further offload processing from the CPUs

PSoC™ Creator and ModusToolbox™ software offer many Components and extensive APIs in the PDL to support the peripherals' functions. This allows you to develop an effective multiprocessing system in a single chip, offloading many functionalities from the CPUs. This, in turn, can not only reduce code size, but by reducing the number of tasks that the CPUs must perform, presents an opportunity to reduce CPU speed and power consumption.

For example, you can implement a digital system to control multiplexed ADC inputs, and interface with DMA to save the data in the SRAM to create an advanced analog data collection system with zero usage of the CPUs.

ModusToolbox™ software provides a set of tools for setting up peripherals, pre-defined BSPs for all Infineon kits, libraries for popular functionality like CAPSENSE™ and emWin, and a comprehensive array of example applications to get you started.

Infineon offers extensive application note and [code example](#) support for PSoC™ peripherals, as well as detailed data in the device datasheets, PDL documentation, HAL documentation, and technical reference manuals (TRMs). For more information, see Related Documents.

References

References

For a comprehensive list of PSoC™ 6 MCU resources, see KBA223067 in the [Infineon Support](#).

Application notes

AN228571 - Getting started with PSoC™ 6 MCU on ModusToolbox™ software	Describes PSoC™ 6 MCU devices and how to build your first ModusToolbox™ project
AN221774 - Getting started with PSoC™ 6 MCU on PSoC™ Creator	Describes PSoC™ 6 MCU devices and how to build your first ModusToolbox™ or PSoC™ Creator project
AN210781 - Getting started with PSoC™ 6 MCU with Bluetooth® low energy connectivity on PSoC™ Creator	Describes PSoC™ 6 MCU with Bluetooth® LE Connectivity devices and how to build your first PSoC™ Creator project
AN217666 - PSoC™ 6 MCU interrupts	Describes PSoC™ 6 MCU interrupt architecture and how to configure interrupts
AN219434 - Importing PSoC™ Creator Code into an IDE for a PSoC™ 6 MCU Project	Describes how to import the code generated by PSoC™ Creator into your preferred IDE

Code examples (PSoC™ Creator)

CE216795 - PSoC™ 6 MCU dual-CPU basics	Demonstrates the two CPU cores in PSoC™ 6 MCU doing separate independent tasks and communicating with each other using shared memory and the inter-processor communication (IPC) block
CE223820 - PSoC™ 6 MCU IPC pipes	This example demonstrates how to use the inter-processor communication (IPC) driver to implement a message pipe in PSoC™ 6 MCU. The pipe is used to send messages between CPUs
CE223549 - PSoC™ 6 MCU IPC semaphore	This example demonstrates how to use the inter-processor communication (IPC) driver to implement a semaphore in PSoC™ 6 MCU. The semaphore is used as a lock to control access to a resource shared by the CPUs
CE226306 - PSoC™ 6 MCU power measurements	This example shows how to achieve the power measurements listed in the PSoC™ 6 MCU datasheets

Code examples (ModusToolbox™)

mtb-example-psoc6-dual-cpu-empty-app	This is a minimal starter Dual-CPU application template for PSoC™ 6 MCU devices
mtb-example-psoc6-dual-cpu-ipc-sema	This example demonstrates how to use the inter-processor communication (IPC) driver to implement a semaphore in PSoC™ 6 MCU. The semaphore is used to lock to control access to a resource shared by the CPUs and synchronize the initialization instructions
mtb-example-psoc6-dual-cpu-ipc-pipes	This example demonstrates how to use the inter-processor communication (IPC) driver to implement a message pipe in PSoC™ 6 MCU. The pipe is used to send messages between CPUs

PSoC™ Creator component datasheets

Interrupt	Supports generating interrupts from hardware signals
---------------------------	--

Device documentation

PSoC™ 6 MCU datasheets	PSoC™ 6 technical reference manuals
--	---

Development kit documentation

CY8CKIT-062-BLE	PSoC™ 6 Bluetooth® LE Pioneer Kit
CY8CKIT-062-WiFi-BT	PSoC™ 6 Wi-Fi Bluetooth® Pioneer Kit
CY8CKIT-062S2-43012	PSoC™ 6S2 Wi-Fi Bluetooth® Pioneer Kit

References

CY8CPROTO-063-BLE	PSoC™ 6 Bluetooth® LE Prototyping Kit
CY8CPROTO-062-4343W	PSoC™ 6 Wi-Fi Bluetooth® Prototyping Kit
CY8CPROTO-062S3-4343W	PSoC™ 62S3 Wi-Fi Bluetooth® Prototyping Kit
CYW9P62S1-43438EVB-01	PSoC™ 62S1 Wi-Fi Bluetooth® Pioneer Kit
CYW9P62S1-43012EVB-01	PSoC™ 62S1 Wi-Fi Bluetooth® Pioneer Kit
CY8CPROTO-062S2-43439	PSoC™ 62S2 Wi-Fi Bluetooth® Prototyping Kit

Tool documentation

ModusToolbox™ software	ModusToolbox™ software simplifies development for IoT designers. It delivers easy-to-use tools and a familiar microcontroller (MCU) integrated development environment (IDE) for Windows, macOS, and Linux
PSoC™ Creator	PSoC™ Creator enables concurrent hardware and firmware editing, compiling and debugging of PSoC™ devices. Applications are created using schematic capture and over 150 pre-verified, production-ready peripheral Components. Look in the downloads tab for Quick Start and user guides
Peripheral Driver Library (PDL)	Installed by PSoC™ Creator 4.3 and available through GitHub. Visit mtb-pdl-cat1 ; for PSoC™ Creator, look in <PDL install folder>/doc for the User Guide and API Reference
Hardware Abstraction Layer (HAL)	Available through GitHub only. Visit mtb-hal-cat1

Revision history
Revision history

Document version	Date of release	Description of changes
**	2017-02-16	New Application Note
*A	2017-03-08	Updated Template
*B	2017-06-09	Updated text and screen shots for release versions of PSoC™ Creator 4.1 and PDL 3.0.0 Other miscellaneous edits
*C	2017-08-23	Minor edits Ported to new application note document template Confidential tag removed
*D	2018-03-07	Added a new Figure 2 Updated Figure 4 and associated kit device part number Updated Figures 6 and 9 for PSoC™ Creator 4.2 beta 2 Emphasized using CM0+ as a support CPU for tasks such as Bluetooth® LE and CAPSENSE™ Added references to AN221111, Creating a Secure System; AN217666, PSoC™ 6 Interrupts; AN219528, PSoC™ 6 Low Power Modes; and CE216795, PSoC™ 6 Dual-CPU Updated power modes description Miscellaneous minor edits Ported to new application note template Changed the document title to PSoC™ 6 MCU Dual-CPU System Design
*E	2018-06-11	Expanded section 4.3 to include dual-CPU debugging with µVision and IAR Embedded Workbench IDEs Updated power mode descriptions in section 3 Miscellaneous minor edits Ported to *Y application note template
*F	2018-06-12	Added support for ModusToolbox™
*G	2020-05-25	Updated instructions based on ModusToolbox™ 2.1 Added HAL support
*H	2020-08-26	Updated instructions based on ModusToolbox™ 2.2
*I	2022-09-19	Migrated to Infineon template Updated instruction based on ModusToolbox™ 3.0
*J	2023-08-03	Updated link references
*K	2023-12-01	Added the Connectivity application design considerations section and its subsection Removed the Techniques to improve throughput section
*L	2024-02-09	Replaced CY8CPROTO-062-4343W with CY8CPROTO-062S2-43439 and added reference to CY8CPROTO-062S2-43439 in the Development kit documentation table.

Trademarks

Trademarks

The Bluetooth® word mark and logos are registered trademarks owned by Bluetooth SIG, Inc., and any use of such marks by Infineon is under license.

Trademarks

All referenced product or service names and trademarks are the property of their respective owners.

Edition 2024-02-09

Published by

Infineon Technologies AG

81726 Munich, Germany

© 2024 Infineon Technologies AG

All Rights Reserved.

Do you have a question about any aspect of this document?

Email: erratum@infineon.com

Document reference

IFX-jii1649671899455

Important notice

The information contained in this application note is given as a hint for the implementation of the product only and shall in no event be regarded as a description or warranty of a certain functionality, condition or quality of the product. Before implementation of the product, the recipient of this application note must verify any function and other technical information given herein in the real application. Infineon Technologies hereby disclaims any and all warranties and liabilities of any kind (including without limitation warranties of non-infringement of intellectual property rights of any third party) with respect to any and all information given in this application note.

The data contained in this document is exclusively intended for technically trained staff. It is the responsibility of customer's technical departments to evaluate the suitability of the product for the intended application and the completeness of the product information given in this document with respect to such application.

Warnings

Due to technical requirements products may contain dangerous substances. For information on the types in question please contact your nearest Infineon Technologies office.

Except as otherwise explicitly approved by Infineon Technologies in a written document signed by authorized representatives of Infineon Technologies, Infineon Technologies' products may not be used in any applications where a failure of the product or any consequences of the use thereof can reasonably be expected to result in personal injury.