A large, light blue, stylized graphic element consisting of a thick, curved line that forms a partial circle, with a small circle at its top end, resembling a stylized 'C' or a swoosh.

Recommendations for Printed Circuit Board Assembly of Infineon BGA/LBGA/TBGA Packages

Additional Information

DS2, October 2010

Table of Contents

1	Package Description	3
2	Package Handling	4
2.1	ESD Protective Measurement	4
2.1.1	Workplace-ESD Protective Measures	4
2.1.2	Equipment for Personal	4
2.1.3	Production Installations and Processing Tools	4
2.2	Packing of Components	4
2.3	Moisture Sensitive Components (MSL Classification)	5
2.4	Storage and Transportation Conditions	6
2.5	Handling Damage and Contaminations	6
2.6	Component Solderability	6
3	Printed Circuit Board, PCB	7
3.1	Routing	7
3.2	PCB Pad Design	7
3.3	Pad Surfaces	9
4	PCB Assembly	10
4.1	Solder Stencil	10
4.2	Solder Paste	10
4.3	Component Placement	10
4.4	Soldering	11
4.4.1	Double-Sided Assembly	12
4.4.2	Compatibility of Solder Alloys	13
4.5	Cleaning and Subsequent Processing	13
5	Inspection	15
6	Rework	17
6.1	Tooling	17
6.2	Device Removal	17
6.3	Site Redressing	17
6.4	Reassembly and Reflow	17

1 Package Description

Standard P(G)-BGA (Plastic (Green) Ball Grid Array Package), P(G)-LBGA (Plastic (Green) Low Profile Ball Grid Array Package), and P(G)-TBGA (Plastic (Green) Thin Profile Ball Grid Array Package) are plastic overmolded, rigid laminate substrate, ball grid array IC packages. Standard P(G)-BGA (Figure 1) is molded as individual units and singulated by punching, while P(G)-LBGA and P(G)-TBGAs (Figure 2) are molded in an array and singulated by sawing. P(G)-BGA is typically applied for larger body sizes (> 17 mm) and higher IO counts (> 208) than P(G)-LBGA and P(G)-TBGA. P(G)-BGAs have a flange of substrate around the mold cap while in case of P(G)-LBGA and P(G)-TBGAs the mold cap extends to the substrate edge.

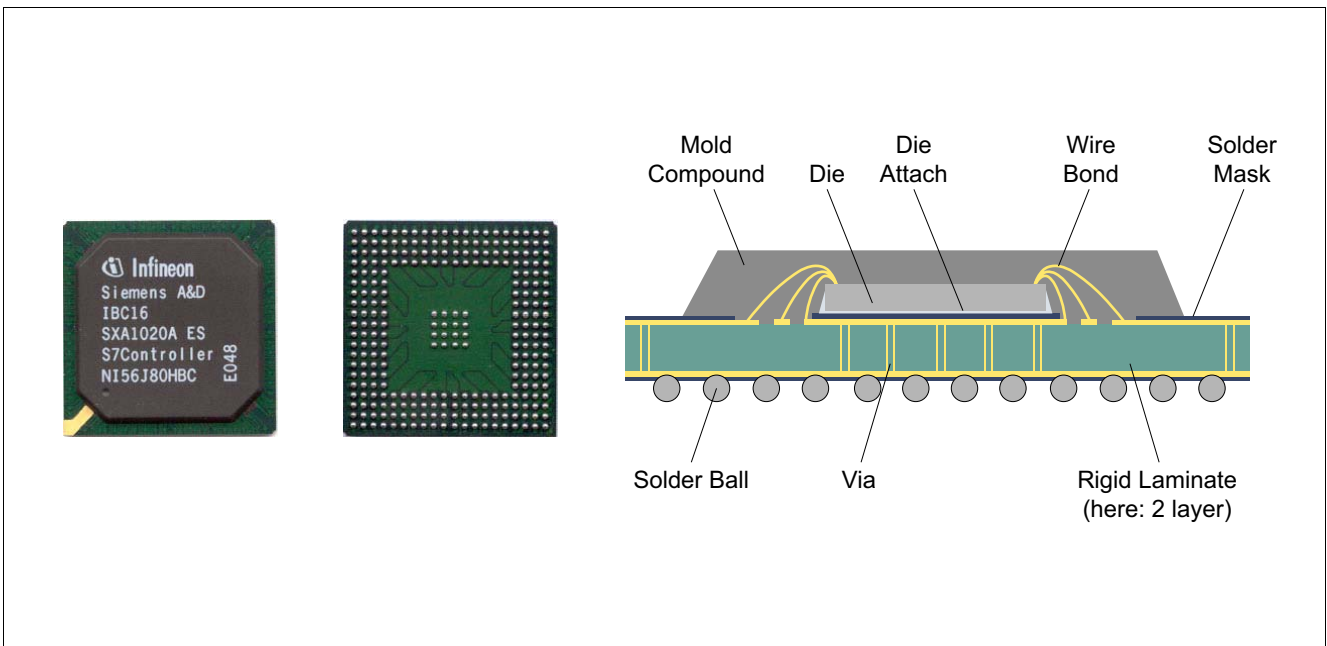

Figure 1 P(G)-BGA Top View, Bottom View and Cross Section

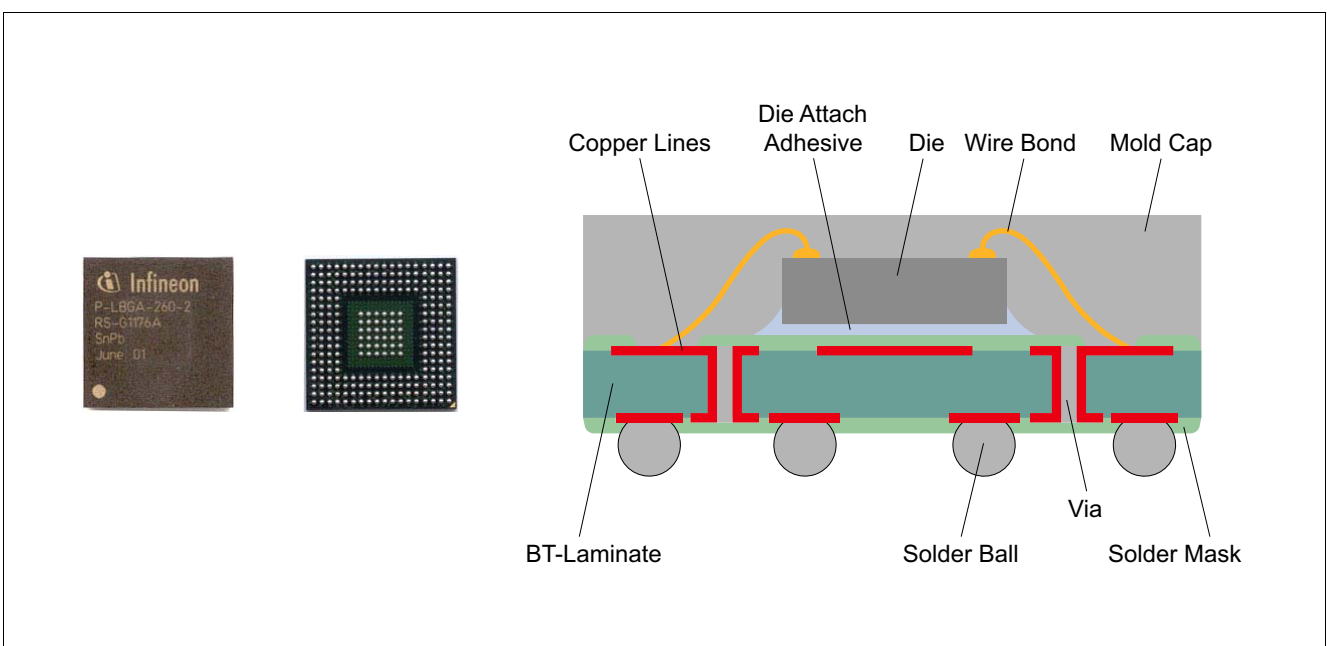

Figure 2 P(G)-LBGA Top View, Bottom View and Cross Section; P(G)-TBGAs only differ in the package thickness (for details please refer to the package outline drawing)

2 Package Handling

2.1 ESD Protective Measurement

Semiconductor devices are normally electrostatic discharge sensitive devices (ESDS) requiring specific precautionary measures regarding handling and processing. Discharging of electrostatic charged objects over an IC, caused by human touch or by processing tools may cause high current respectively high voltage pulses, which may damage or even destroy sensitive semiconductor structures. On the other hand ICs may also be charged during processing.

If discharging takes place too quickly ("hard" discharge), it may cause load pulses and in worst case electrical damages.

ESD protective measures must therefore prevent a contact with charged parts as well as a charging of the ICs. Protective measures against ESD include both the handling and processing and the packing of ESDS. A few hints are provided below on handling and processing.

2.1.1 Workplace-ESD Protective Measures

- Standard marking of ESD protected areas
- Access controls, with wrist strap and footwear testers
- Air conditioning
- Dissipative and grounded floor
- Dissipative and grounded working and storage areas
- Dissipative chairs
- Earth bonding point for wrist strap
- Trolleys with dissipative surfaces and wheels
- Suitable shipping and storage containers
- No sources of electrostatic fields

2.1.2 Equipment for Personal

- Dissipative/conductive footwear or heel straps
- Suitable smocks
- Wrist strap with safety resistor
- Volume conductive gloves or finger cots
- Regular training of staff

2.1.3 Production Installations and Processing Tools

- Machine and tool parts made of dissipative or metallic materials
- No materials having thin insulating layers for sliding tracks
- All parts reliably connected to ground potential
- No potential difference between individual machine and tool parts
- No sources of electrostatic fields

Detailed information on ESD protective measures may be obtained from the ESD Specialist through Area Sales Offices. Our recommendations are based on the internationally applicable standards IEC 61340-5-1 and ANSI/ESD S2020.

2.2 Packing of Components

Please refer to product and package specifications (on IFX-homepage) and our sales department to get information about what packings are available for a given product.

Generally the following list of standards dealing with packing should be considered if applicable for a given package and packing:

IFX packs according to the IEC 60286-* series

- IEC 60286-3 Packaging of components for automatic handling - Part 3:
Packaging of surface mount components on continuous tapes
- IEC 60286-4 Packaging of components for automatic handling - Part 4:
Stick magazines for dual-in-line packages
- IEC 60286-5 Packaging of components for automatic handling - Part 5:
Matrix trays

Moisture Sensitive Surface Mount Devices are packed according to IPC/JEDEC J-STD-033*: Handling, Packing, Shipping and Use of Moisture/Reflow Sensitive Surface Mount Devices

Detailed Packing drawings: [Packing Information \(Internet\)](#)

Other references:

- ANSI/EIA-481-* Standards Proposal No. 5048, Proposed Revision of ANSI/EIA-481-B 8 mm through 200 mm Embossed Carrier Taping and 8 mm & 12 mm Punched Carrier Taping of Surface Mount Components for Automatic Handling (if approved, to be published as ANSI/EIA-481-C)
- EIA-783 Guideline Orientation Standard for Multi-Connection Package (Design Rules for Tape and Reel Orientation)

2.3 Moisture Sensitive Components (MSL Classification)

For moisture-sensitive packages it is necessary to control the moisture content of the components. The penetration of moisture into the package molding compound is generally caused by exposure to the ambient air. In many cases moisture absorption leads to moisture concentrations in the component which are high enough to damage the package during the reflow process. Thus it is necessary to dry moisture-sensitive components, to seal them in a moisture-resistant bag and only to remove them immediately prior to assembly onto the PCB. The permissible time (from opening the moisture barrier bag until the final soldering process), which a component can remain outside the moisture barrier bag, is a measure of the sensitivity of the component to ambient humidity (Moisture Sensitivity Level, MSL). The most commonly applied standard IPC/JEDEC J-STD-033* defines eight different MSLs (see [Table 1](#)). Please refer to the “Moisture Sensitivity Caution Label” on the packing material, which contains information about the moisture sensitivity level of our product. IPC/JEDEC-J-STD-20 specifies the maximum reflow temperature, which shall not be exceeded during the board assembly at the customer.

Table 1 Moisture Sensitivity Levels (according to IPC/JEDEC J-STD-033*)

Level	Floor Life (out of bag)	
	Time	Conditions
1	Unlimited	≤ 30°C / 85% RH
2	1 year	≤ 30°C / 60% RH
2a	4 weeks	≤ 30°C / 60% RH
3	168 hours	≤ 30°C / 60% RH ¹⁾
4	72 hours	≤ 30°C / 60% RH ¹⁾
5	48 hours	≤ 30°C / 60% RH
5a	24 hours	≤ 30°C / 60% RH ¹⁾
6	Mandatory bake before use. After bake, must be reflowed within the time limit specified on the label.	≤ 30°C / 60% RH

If moisture-sensitive components have been exposed to ambient air for longer than the specified time according to their MSL, or the humidity indicator card after opening the dry package indicates too much moisture, the packages have to be baked prior to the assembly process. Please refer to IPC/JEDEC J-STD-033* for details. Baking a package too often can cause solderability problems due to oxidation and/or intermetallic growth. Notice that packing material possibly can not withstand the baking temperature. Please refer to imprints/labels on the respective packing for maximum temperature.

2.4 Storage and Transportation Conditions

Improper transportation and unsuitable storage of components can lead to a number of problems during subsequent processing, such as poor solderability, delamination and package cracking effects.

List of relevant standards which should be considered:

- IEC 60721-3-0 Classification of environmental conditions: Part 3:
Classification of groups of environmental parameters and their severities; introduction
- IEC 60721-3-1 Classification of environmental conditions: Part 3:
Classification of groups of environmental parameters and their severities; Section 1: Storage
- IEC 60721-3-2 Classification of environmental conditions: Part 3:
Classification of groups of environmental parameters and their severities; Section 2: Transportation
- IEC 61760-2 Surface mounting technology - Part 2:
Transportation and storage conditions of surface mounting devices (SMD) - Application guide
- IEC 62258-3 Semiconductor Die Products - Part 3:
Recommendations for good practise in handling, packing and storage
- ISO 14644-1 Clean rooms and associated controlled environments Part 1:
Classification of airborne particulates

Table 2 General Storing Conditions - Overview

Product	Condition for Storing
Wafer/Die	N2 or MBB (IEC 62258-3)
Component - moisture sensitive	MBB ¹⁾ (JEDEC J-STD-033*)
Component - not moisture sensitive	1K2 (IEC 60721-3-1)

1) MBB = Moisture Barrier Bag

Maximum storage time:

The conditions to be complied with in order to ensure problem-free processing of active and passive components are described in standard IEC 61760-2.

Internet links to standards institutes:

[American National Standards Institutes \(ANSI\)](#)

[Electronics Industries Alliance \(EIA\)](#)

[Association Connecting Electronics Industries \(IPC\)](#)

2.5 Handling Damage and Contaminations

Any mechanical damage during automatic or manual handling of components in or out of the component packing which may harm package leads and/or body has to be avoided.

Generally the components in the packing are ready to use.

Any contaminations applied to component or packing may cause or induce (together with other factors) processes which may lead to a damaged device. The most critical damages are:

- solderability problems
- corrosion
- electrical shorts (due conductive particles)

2.6 Component Solderability

The solder balls of P(G)-BGA / P(G)-LBGA / P(G)-TBGA packages assure good solderability, even after a long storage time. Suitable methods for the assessment of solderability can be derived from JESD22B 102 or IEC6068-2-58.

Please also refer to [Chapter 4.4.2](#) regarding the compatibility between different solder alloys.

3 Printed Circuit Board, PCB

3.1 Routing

The main difference between the P(G)-BGA / P(G)-LBGA / P(G)-TBGA and conventional SMT leadframe packages is the array configuration of solder spheres on the package, which implies different concepts for routing the signal, power and ground pins on the PCB.

Generally the printed circuit board design and construction is a key factor for achieving a high reliability of the solder joints. For example, it is recommended not to place P(G)-BGA / P(G)-LBGA / P(G)-TBGA packages at the same opposite locations on the PCB (if double sided mounting is used), because this results in a stiffening of the assembly with earlier solder joint fatigue compared to a design where the component locations are shifted against each other. Furthermore it is known, that the lower bending stiffness of thinner boards (e.g. 1.0 mm) are favorable for solder joint reliability (temperature cycling) compared to thick boards (e.g. 2.35 mm).

Typically fineline PCBs with conductor width/spacing of 100 µm are necessary for routing. The details of the used PCB design strongly depends on the board technology (conventional technology with drilled vias, build-up technology with microvias), the conductor width/spacing, number of metal layers, and electrical restrictions.

3.2 PCB Pad Design

The solder pads have to be designed to assure optimum manufacturability and reliability. Generally two basic types of solder pads are commonly used:

- “Solder mask defined” (SMD) pad ([Figure 3](#)): The copper pad is larger than the solder mask opening above this pad. Thus the land area is defined by the opening in the solder mask.

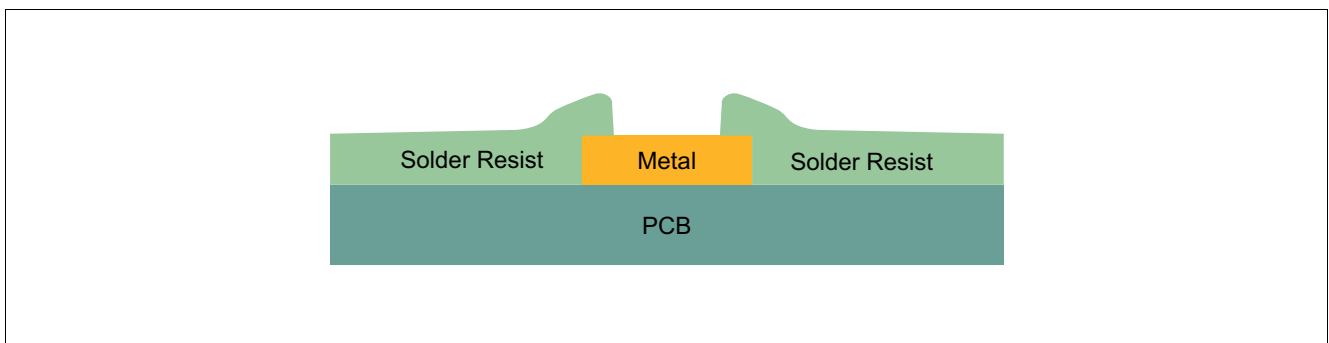

Figure 3 SMD Pad

- “Non solder mask defined” (NSMD) pad ([Figure 4](#)): Around each copper pad there is solder mask clearance. It is necessary to specify the dimensions and tolerances of the solder mask clearance in this way, that no overlapping of the solder pad by solder mask occurs (depending on PCB manufacturers tolerances, 75 µm is a widely used value).

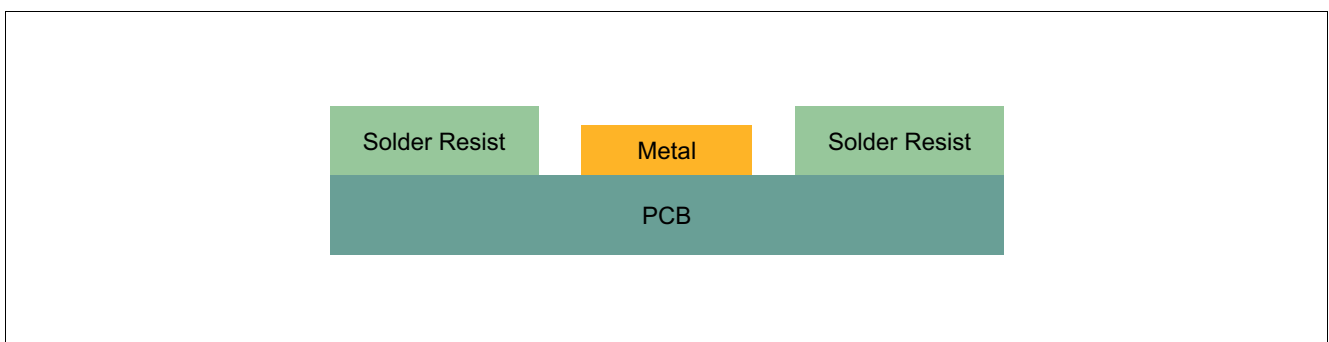

Figure 4 NSMD Pad

Because NSMD pads provide more space for routing and result in a higher solder joint reliability (also the side walls of the lands are wetted by the solder, which results in less stress concentration), NSMD type is recommended for the solder pads on the PCB.

Figure 5 shows the recommended PCB Pad design. Refer to **Table 3** for the appropriate dimensions, which are ball pitch specific. The values in the table are typical dimensions. The details depend on the used PCB technology, capability of the suppliers and the planned routing. If drilled via holes are placed between the pads, they should be plugged or plated closed to prevent solder flow into this via. If microvias are placed inside the pads, it is recommended to specify a good flatness of the vias. Deep dips inside the pads may cause solder joint voiding.

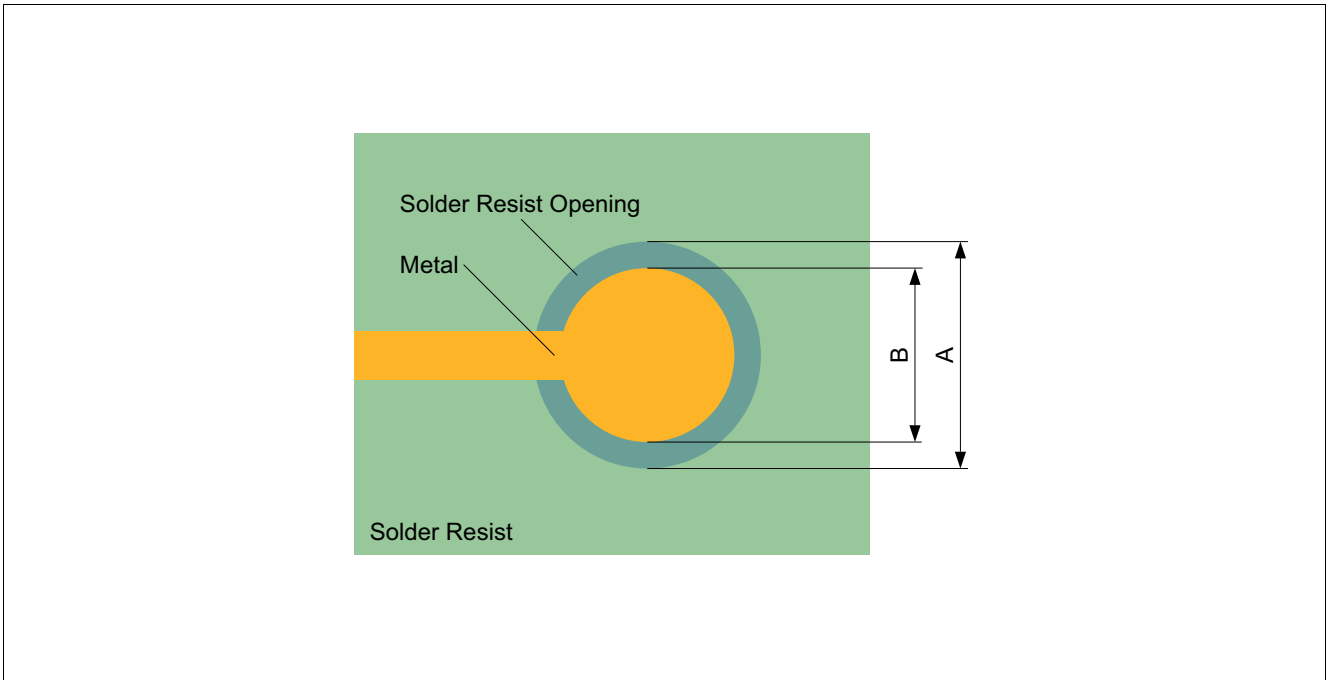

Figure 5 PCB Pad Design Recommendation (NSMD Pad)

Table 3 PCB Pad Dimensions

Ball Pitch [mm] / Ball Diameter [mm]	1.00/0.40	1.00/0.50	1.00/0.60	1.27/all
Solder resist opening diameter A [μm]	450	500	600	800
Metal pad diameter B [μm]	300	350	400	600

3.3 Pad Surfaces

The solder pads have to be easy for the solder paste to wet. In general, all finishes are well-proven for SMT assembly, but the quality of the plating/finish is more important for fine-pitch applications in particular. Because of the uneven surface of Hot Air Solder Leveling (HASL) finish, Pb-free or Pb-containing HASL is less preferred for assembly (especially for pitches < 0.65 mm) compared to completely “flat” platings such as Cu-OSP (OSP: Organic Solderability Preservative) or electroless Sn or NiAu.

From a package point of view, it is difficult to recommend a certain PCB pad finish that will always meet all requirements. The choice of finish also depends strongly on board design, pad geometry, all components on the board, and process conditions, and must be chosen accordingly to the specific needs of the customer.

Infineon’s internal tests have shown that Cu-OSP is a suitable and reliable plating.

Table 4 Typical PCB Pad Finishes

Finish	Typical Layer Thickness [µm]	Properties	Concerns
HASL (SnAg) (Hot Air Leveling)	> 5	low cost, widely usage, know how in fabrication	uneven surface, formation of humps, flatness of single pads has to be good for fine pitch applications
Electroless Tin	0.3 - 1.2	solder joint consists only of copper and solder, no further metal is added to the solder joint	long-term stability of protection may be a concern, baking of PCB may be critical
Electroless Silver	0.2 - 0.5	solder joint consists only of copper and solder, no further metal is added to the solder joint	long-term stability of protection may be a concern, baking of PCB may be critical
Electroless Ni / Immersion Au (ENIG)	3 - 7 / 0.05 - 0.15	good solderability protection, high shear force values	expensive, concerns about brittle solder joints
Galvanic Ni/Au	> 3 / 0.1 - 2	only for thicker layers, typically used for connectors	expensive, not recommended for solder pads
OSP (Organic Solderability Preservatives)	typical 1	low cost, simple, fast and automated fabrication	must be handled carefully to avoid damaging the OSP; not as good long-term stability as other coatings; in case of double-sided assembly only suitable with inert gas during reflow

4 PCB Assembly

4.1 Solder Stencil

The solder paste is applied onto the PCB metal pads by screen printing. The volume of the printed solder paste is determined by the stencil aperture and the stencil thickness. In most cases the thickness of a stencil has to be matched to the needs of all components on the PCB. For P(G)-BGA, P(G)-LBGA and P(G)-TBGA packages it is recommended to use 100 - 150 μm thick stencils. Stencil apertures should be of circular shape. The aperture diameter should be the same as the metal pad diameter on the PCB or slightly above.

To ensure a uniform and high solder paste transfer to the PCB, lasercut (mostly made from stainless steel) or electroformed stencils (Nickel) should be preferred.

Table 5 Recommendations for Stencil Dimensions

Package	Stencil Aperture Diameter [μm]	Stencil Thickness [μm]
P(G)-TBGA, Ball pitch 1.00 mm, Ball diameter 0.40 mm	300 - 350	100 - 125
P(G)-BGA, P(G)-LBGA, Ball pitch 1.00 mm, Ball diameter 0.50 mm	350 - 400	100 - 150
P(G)-LBGA, Ball pitch 1.00 mm, Ball diameter 0.60 mm	400 - 450	100 - 150
P(G)-BGA, Ball pitch 1.27 mm	600 - 650	100 - 150

4.2 Solder Paste

Solder paste consists of solder alloy and a flux system. Normally the volume is split into about 50% alloy and 50% flux. In term of mass this means approx. 90 wt% alloy and 10 wt% flux system. The flux system has the function to remove the contaminations from the solder joints during the soldering process. The capability of removing contaminations is given by the respective activation level. The solder paste metal alloy has to be of leaded eutectic or near-eutectic composition (SnPb or SnPbAg) or lead-free composition (SnAgCu whereas Ag 3 - 4%, Cu 0.5 - 1%). A "no-clean" solder paste is preferred, because cleaning under the soldered P(G)-BGA / P(G)-LBGA / P(G)-TBGA may be difficult. The paste must be suitable for printing the solder stencil aperture dimensions, Type 3 paste is recommended. Solder paste is sensitive to age, temperature and humidity. Please notice the handling recommendations of the paste manufacturer.

4.3 Component Placement

P(G)-BGA / P(G)-LBGA / P(G)-TBGA packages have to be placed accurately according to their geometry. Positioning the packages manually is not recommended.

Component placement accuracies of $\pm 50 \mu\text{m}$ are obtained with modern automatic component placement machines using vision systems. With these systems both the PCB and the components are optically measured and the components are placed on the PCB at their programmed positions. The fiducials on the PCB are located either on the edge of the PCB for the entire PCB or additionally on individual mounting positions (local fiducials). They are detected by a vision system immediately before the mounting process. Recognition of the packages is performed by a special vision system, enabling a correct centering of the complete package.

If they are slightly displaced, packages with solder balls as the P(G)-BGA / P(G)-LBGA / P(G)-TBGA have the favorable property of self alignment during the reflow process due to the solder's high surface tension. As a rule of thumb a maximum tolerable displacement of the components is 30% of the metal pad diameter on the PCB (for non solder mask defined pads). In consequence, for P(G)-BGA / P(G)-LBGA / P(G)-TBGA packages the solder ball to PCB pad misalignment has to be better than 150 μm to assure a robust mounting process. Generally this is achievable with a wide range of placement systems.

The following remarks are important:

- Especially on large boards local fiducials close to the device can compensate a large amount of PCB tolerances.
- It is recommended to use the ball recognition capabilities of the placement system, not the outline centering. This eliminates the solder ball to package edge tolerances of the package (please refer to the respective package outline drawing for details).
- To ensure the identification of the packages by the vision system, an adequate lighting as well as the correct choice of the measuring modes are necessary. The accurate settings can be taken from the equipments manuals.
- Too much placement force can lead to squeezed out solder paste and cause solder joint shorts. On the other hand too low placement force can lead to insufficient contact between package and solder paste and this can lead to open solder joints or badly centered packages.

4.4 Soldering

Soldering determines the yield and quality of assembly fabrication to a very large extent. Generally all standard reflow soldering processes

- forced convection
- vapour phase
- infrared (with restrictions)

and typical temperature profiles are suitable for board assembly of P(G)-BGA / P(G)-LBGA / P(G)-TBGA packages. Wave soldering is not possible. At the reflow process each solder joint has to be exposed to temperatures above solder liquidus for a sufficient time to get the optimum solder joint quality, whereas overheating the PCB with its components has to be avoided. Please refer to the bar code label on the packing for the peak package body temperature. When using infrared ovens without convection special care may be necessary to assure a sufficiently homogeneous temperature profile for all solder joints on the PCB, especially on large, complex boards with different thermal masses of the components, including those under the P(G)-BGA / P(G)-LBGA / P(G)-TBGA. The most recommended type is forced convection reflow. Nitrogen atmosphere can generally improve solder joint quality, but is normally not necessary for soldering tin-lead metal alloys.

The temperature profile of a reflow process is one of the most important factors of the soldering process. The temporal progression of the temperature profile is divided into several phases, each with a special function. **Figure 6** shows a general forced convection reflow profile for soldering P(G)-BGA / P(G)-LBGA / P(G)-TBGA packages, **Table 6** shows an example of the key data of such a solder profile for Tin-lead and for lead-free alloys. The single parameters are influenced by various facts, not only by the package. It is essential to follow the solder paste manufactures application notes, too. Additionally, most PCBs contain more than one package type and therefore the reflow profile has to be matched to all components' and materials' demands. We recommend to measure the solder joints' temperatures by thermocouples beneath the respective packages. It has to be considered, that components with large thermal masses don't heat up in the same speed as lightweight components, and also the position and the surrounding of the package on the PCB, as well as the PCB thickness can influence the solder joint temperature significantly. Therefore no concrete temperature profile can be given.

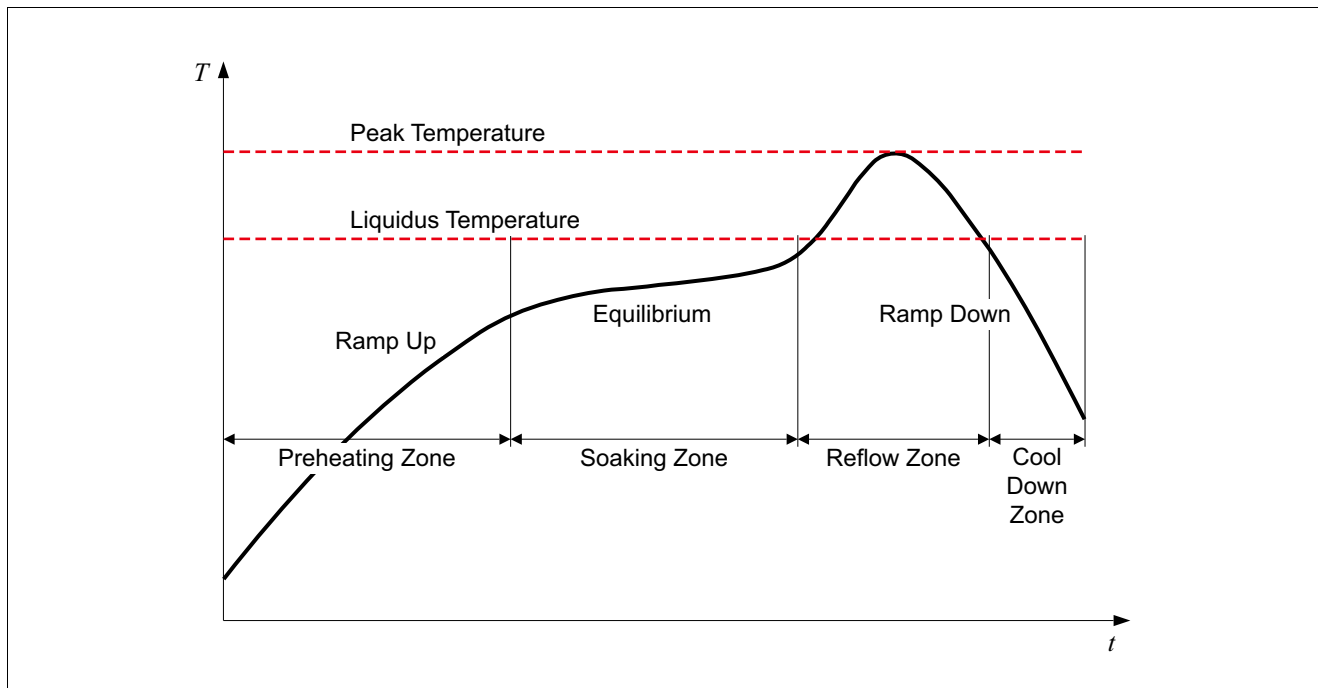

Figure 6 General Forced Convection Reflow Solder Profile

The following table is an example, not a recommendation (for reference only).

Table 6 EXAMPLE for the Key Data of a Forced Convection Reflow Solder Profile

Parameter	Tin-lead Alloy (SnPb or SnPbAg)	Lead-free Alloy (SnAgCu)	Main Requirements From
Preheating rate	2.5 K/s	2.5 K/s	Flux system (Solder paste)
Soaking temperature	140 - 170°C	140 - 170°C	Flux system (Solder paste)
Soaking time	80 s	80 s	Flux system (Solder paste)
Peak temperature	225°C	245°C	Alloy (Solder paste)
Reflow time over Liquidus	60 s	60 s	Alloy (Solder paste)
Cool down rate	2.5 K/s	2.5 K/s	

4.4.1 Double-Sided Assembly

P(G)-BGA / P(G)-LBGA / P(G)-TBGA packages are generally suitable for mounting on double-sided PCBs. That means that in a first step one side of the PCB is fitted with components and soldered. Afterwards the second side of the PCB is fitted with components and soldered again. Be aware that especially packages with a high mass could fall off during the second reflow process, while heading face down. In such cases this packages have to be assembled with the last (= second) reflow process. As a rule of thumb a weight limit of 0.2 g/mm² soldered area (NSMD pad) can be assumed. Which packages are affected depends not only on the mass, but also on the vibrations and the air draft in the reflow oven.

4.4.2 Compatibility of Solder Alloys

Due to the possible usage of different solder alloys for package balls and solder paste printed on the PCB, the compatibility of these alloys has to be taken into account. The following table describes the possible combinations and our recommendation which of them may serve for good processability and reliability.

Table 7 Possible Combinations of Lead-Based and Lead-Free Solder Balls and Solder Paste

	SnPb(Ag) Solder Paste (= low peak temperature)	SnAgCu Solder Paste (= high peak temperature)
SnPb(Ag) solder ball	ok	ok
SnAgCu solder ball	Reliability concerns / with restrictions (see the following notes)	ok

In respect of material combination it is possible to mix SnPb(Ag) solder paste with SnAgCu solder balls. Of particular interest is the required minimum peak temperature at reflow for the combination lead-free solder ball and SnPb(Ag) solder paste. The following table is the result of an in-house evaluation about this topic.

Table 8 Correlation between Processability and Peak Temperature / Coplanarity

Peak Temperature (at solder joint)	Regular Coplanarity
200 - 215°C	no
220 - 230°C	yes with restrictions
235 - 260°C	yes

Below a peak temperature of 215°C no suitable solder joints are formed. With peak temperature around 225°C suitable solder joints are only possible, if the packages have good coplanarity values. Due to reduced self-alignment of the BGA packages at this temperature, the package must be placed exactly on the solder paste. With a peak temperature over 230°C suitable solder joints are formed.

4.5 Cleaning and Subsequent Processing

Cleaning

After the reflow soldering process some flux residues can be found around the solder joints. If a “no-clean” solder paste has been used for solder paste printing, the flux residues usually don’t have to be removed after the soldering process. Be aware, that cleaning beneath a P(G)-BGA / P(G)-LBGA / P(G)-TBGA package is difficult because of the small gap between package substrate and PCB and is therefore not recommended. Whether the solder joints have to be cleaned, however, the cleaning method (e.g. ultrasonic, spray or vapor cleaning) and solution has to be selected with consideration of the packages to be cleaned, the used flux in the solder paste (rosin-based, water-soluble, etc.), environmental and safety aspects. Removing/Drying even of small residues of the cleaning solution should also be done very thorough. Contact the solder paste manufacturer for recommended cleaning solutions.

Underfilling

The application of an underfill material under the package is an efficient method to improve the board level reliability regarding mechanical and thermomechanical stress, especially for smaller ball pitches.

A liquid epoxy resin is dispensed on the PCB next to the package outline at a distance that allows the material to wet the gap between package and board. Through capillary action the underfiller is then driven into the gap and fills it completely.

The process parameters are dependent on the used underfill material, the package size, ball matrix, and design of the PCB. To achieve shorter flow times the substrate is usually heated up to 50°C to 90°C during dispensing to reduce the fluid viscosity. For small package sizes (approx. < 40 mm²) it is sufficient to deposit the underfiller only on one side in a line-shaped dispense move (length approx. 75% of package side). For larger packages it is

recommended to dispense a L-shape pattern on two adjacent sides. For very large packages it may be necessary to dispense an additional second L-shape after the flow out of the first dispensed material to achieve a complete filling. U-shape patterns are an alternative for large packages but bear a risk for entrapping air by colliding flow fronts.

Typically liquid, filled or unfilled epoxy resins are used for package underfilling. Ultra fine-fillers are not needed and it is possible to use low cost materials with larger filler particles (max. filler size should be $\leq 1/3$ of the gap).

5 Inspection

A visual inspection of the solder joints with conventional AOI (automatic optical inspection) systems is not possible. The only reasonable method to realize an efficient inline control is the implementation of AXI (automatic X-ray inspection) systems. AXI systems are available as 2D and 3D solutions. They usually consist of an X-ray camera and the hard- and software needed for inspection, controlling, analysing and data transfer routines. These systems enable the user to detect soldering defects like poor soldering, bridging, voiding and missing parts quite reliable. But other defects like broken solder joints are not easily detectable by X-ray. For the acceptability of electronic assemblies please refer also to the IPC-A-610C standard.

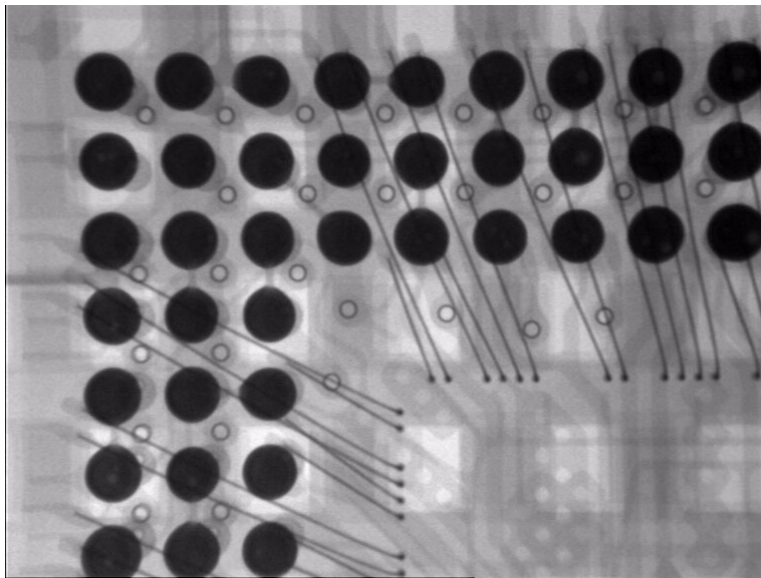

Figure 7 Typical X-ray Image of Soldered BGA Package

Another kind of inspection equipment are endoscopes. With them a lot of failures can be detected beneath BGAs. The optical head of the system moves around the package near the PCB area. The user can look along the solder rows by adjusting the focus. The pictures from such a endoscope system are much more easy to interpret than X-ray images.

Cross sectioning of a soldered package as well as dye penetrant analysis can serve as tools for sample monitoring only, because of their destructive character.

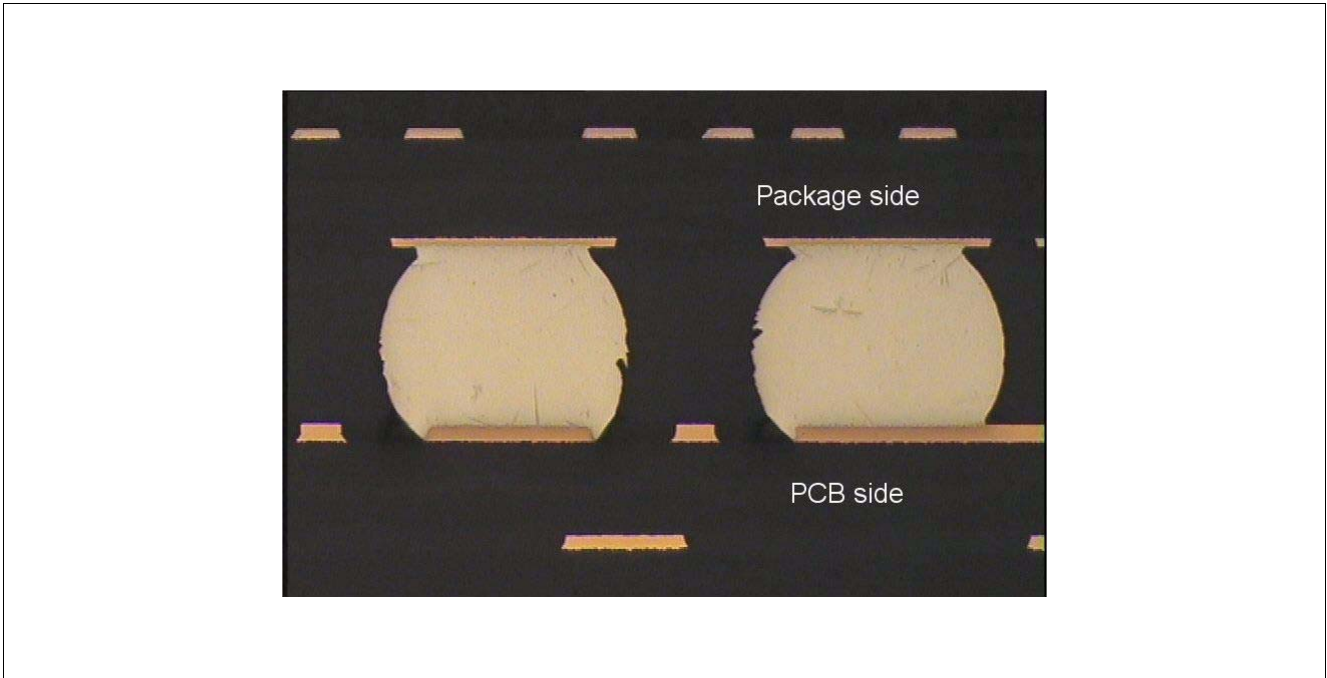

Figure 8 Sample Cross Section of BGA Solder Balls

Please note that lead-free solder joints look different than tin-lead solder joints. The surface properties are caused by the irregular solidification of the solder. As the used solder alloys are not exactly eutectic (like the 63Sn37Pb solder alloy) they do not have a melting point but a melting range of some degrees difference.

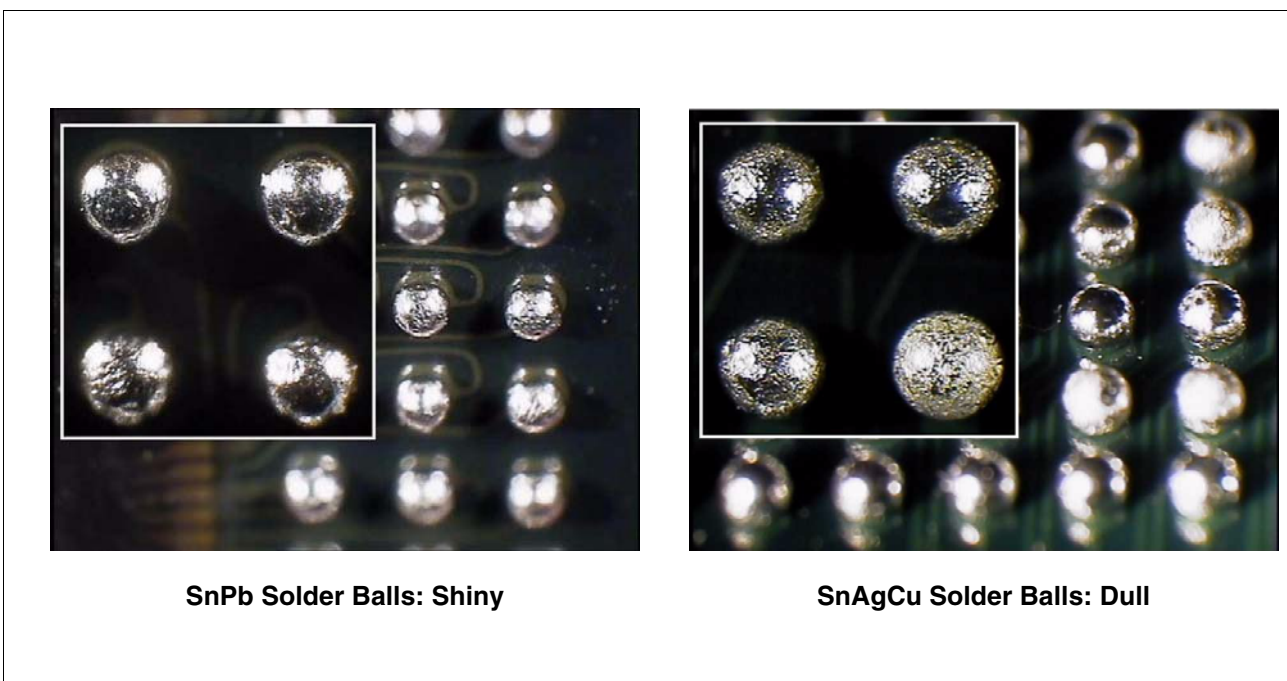

Figure 9 Comparison of Solder Ball Appearance

6 Rework

If a defect component is observed after board assembly the device can be removed and replaced by a new one. Repair of components' single solder joints is not possible.

6.1 Tooling

The rework process is commonly done on special rework equipment. There are a lot of systems available on the market, and for processing these packages the equipment should fulfill the following requirements:

- *Heating:* Hot air heat transfer to the package and PCB is strongly recommended. Temperature and air flow for heating the device should be controlled. With free-programmable temperature profiles (e.g. by PC controller) it is possible to adapt the profiles to different package sizes and masses. PCB preheating from underside is recommended. Infrared heating can be applied, especially for preheating the PCB from underside, but it should be only supporting the hot air flow from the upside. Instead of air also nitrogen can be used.
- *Vision system:* The bottom side of the package as well as the site on the PCB should be observable. For precise alignment of package to PCB a split optic should be implemented. Microscope magnification and resolution should be appropriate for the pitch of the device.
- *Moving and additional tools:* The device should be relocatable on the whole PCB area. Placement accuracy is recommended to be better than $\pm 100 \mu\text{m}$. The system should have the capability of removing solder residues from PCB pads (special vacuum tools).

6.2 Device Removal

If it is intended to send a defect component back to the supplier, please note that during the removal of this component no further defects must be introduced to the device, because this may hinder the failure analysis at the supplier. This includes the following recommendations:

- *Moisture:* According to his moisture sensitivity level, possibly the package has to be dried before removal. If the maximum storage time out of the dry pack (see label on packing material) is exceeded after board assembly, the PCB has to be dried according to the recommendations (see [Chapter 4.4](#)), otherwise too much moisture may have been accumulated and damage may occur (popcorn effect).
- *Temperature profile:* During soldering process it should be assured that the package peak temperature is not higher and temperature ramps are not steeper than for the standard assembly reflow process (see [Chapter 4.4](#)).
- *Mechanics:* Be aware not to apply high mechanical forces for removal. Otherwise failure analysis of the package can be impossible or PCB can be damaged. For large packages pipettes can be used (implemented on most rework systems), for small packages tweezers may be more practical.

Especially if suspected components are underfilled it is necessary to clarify if they can be electrically tested at Infineon Technologies directly after desoldering or if these components have to be re-balled first. The underfill may hinder to contact or to re-ball such desoldered components.

In this case and also if a gentle removing of the suspected component which should be analysed at the supplier is not possible or too risky, it is necessary to send back the whole (or part of the) PCB containing the defect component.

6.3 Site Redressing

After removing the defect component the pads on the PCB have to be cleaned from solder residues. Don't use steel brushes because steel residues can lead to bad solder joints. Before placing a new component it is recommended to apply flux by dispensing it on each PCB pad or by obliterating it over the whole site (e.g. by a brush). It is recommended to use only no-clean flux, if possible the same one that is used in your solder paste for stencil printing.

6.4 Reassembly and Reflow

After preparing the site, the new package can be placed onto the PCB. The package is positioned exactly above the PCB pads, in height just that there is no contact between the package and the PCB and the package is then dropped into the printed or dispensed flux or solder paste depot (Zero-force-placement). During soldering process it should be assured that the package peak temperature is not higher and temperature ramps are not steeper than for the standard assembly reflow process (see [Chapter 4.4](#)).

Packages with lead-free balls can be reworked like leaded packages, but peak temperatures have to be adjusted according to the used solder (see also [Chapter 4.4](#)) and overheating has to be avoided.

Edition 2010-06

**Published by
Infineon Technologies AG
81726 Munich, Germany**

**© 2010 Infineon Technologies AG
All Rights Reserved.**

Legal Disclaimer

The information given in this document shall in no event be regarded as a guarantee of conditions or characteristics. With respect to any examples or hints given herein, any typical values stated herein and/or any information regarding the application of the device, Infineon Technologies hereby disclaims any and all warranties and liabilities of any kind, including without limitation, warranties of non-infringement of intellectual property rights of any third party.

Information

For further information on technology, delivery terms and conditions and prices, please contact the nearest Infineon Technologies Office (www.infineon.com).

Warnings

Due to technical requirements, components may contain dangerous substances. For information on the types in question, please contact the nearest Infineon Technologies Office.

Infineon Technologies components may be used in life-support devices or systems only with the express written approval of Infineon Technologies, if a failure of such components can reasonably be expected to cause the failure of that life-support device or system or to affect the safety or effectiveness of that device or system. Life support devices or systems are intended to be implanted in the human body or to support and/or maintain and sustain and/or protect human life. If they fail, it is reasonable to assume that the health of the user or other persons may be endangered.

www.infineon.com

Published by Infineon Technologies AG