

CoolMOS® Power Transistor

Product Summary

V_{DS}	600	V
$R_{DS(on),max}$	0.045	Ω
$Q_{g,typ}$	150	nC

Features

- Worldwide best $R_{ds,on}$ in TO247
- Ultra low gate charge
- Extreme dv/dt rated
- High peak current capability
- Automotive AEC Q101 qualified
- Green package (RoHS compliant)

CoolMOS CPA is specially designed for:

- DC/DC converters for Automotive Applications

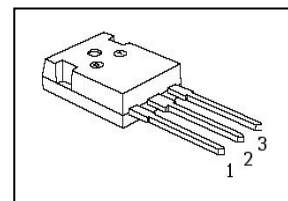
PG-TO247-3

Type	Package	Marking
IPW60R045CPA	PG-TO247-3	6R045A

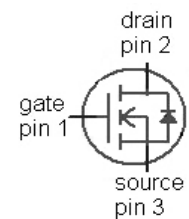
Maximum ratings, at $T_j=25\text{ °C}$, unless otherwise specified

Parameter	Symbol	Conditions	Value	Unit
Continuous drain current	I_D	$T_C=25\text{ °C}$	60	A
		$T_C=100\text{ °C}$	38	
Pulsed drain current ¹⁾	$I_{D,pulse}$	$T_C=25\text{ °C}$	230	
Avalanche energy, single pulse	E_{AS}	$I_D=11\text{ A}$, $V_{DD}=50\text{ V}$	1950	mJ
Avalanche energy, repetitive t_{AR} ^{1),2)}	E_{AR}	$I_D=11\text{ A}$, $V_{DD}=50\text{ V}$	3	
Avalanche current, repetitive t_{AR} ^{1),2)}	I_{AR}		11	A
MOSFET dv/dt ruggedness	dv/dt	$V_{DS}=0\dots480\text{ V}$	50	V/ns
Gate source voltage	V_{GS}	static	± 20	V
Power dissipation	P_{tot}	$T_C=25\text{ °C}$	431	W
Operating temperature	T_j		-40 ... 150	°C
Storage temperature	T_{stg}		-40 ... 150	
Mounting torque		M3 and M3.5 screws	60	Ncm

Maximum ratings, at $T_j=25\text{ °C}$, unless otherwise specified

Parameter	Symbol	Conditions	Value	Unit
Continuous diode forward current	I_S	$T_C=25\text{ °C}$	44	A
Diode pulse current ¹⁾	$I_{S,pulse}$		230	
Reverse diode dv/dt ³⁾	dv/dt		15	V/ns

Parameter	Symbol	Conditions	Values			Unit
			min.	typ.	max.	

Thermal characteristics

Thermal resistance, junction - case	R_{thJC}		-	-	0.29	K/W
Thermal resistance, junction - ambient	R_{thJA}	leaded	-	-	62	
Soldering temperature, wavesoldering only allowed at leads	T_{sold}	1.6 mm (0.063 in.) from case for 10 s	-	-	260	°C

Electrical characteristics, at $T_j=25\text{ °C}$, unless otherwise specified
Static characteristics

Drain-source breakdown voltage	$V_{(BR)DSS}$	$V_{GS}=0\text{ V}$, $I_D=250\text{ }\mu\text{A}$	600	-	-	V
Gate threshold voltage	$V_{GS(th)}$	$V_{DS}=V_{GS}$, $I_D=3\text{ mA}$	2.5	3	3.5	
Zero gate voltage drain current	I_{DSS}	$V_{DS}=600\text{ V}$, $V_{GS}=0\text{ V}$, $T_j=25\text{ °C}$	-	-	10	μA
Gate-source leakage current	I_{GSS}	$V_{GS}=20\text{ V}$, $V_{DS}=0\text{ V}$	-	-	100	nA
Drain-source on-state resistance	$R_{DS(on)}$	$V_{GS}=10\text{ V}$, $I_D=44\text{ A}$, $T_j=25\text{ °C}$	-	0.04	0.045	Ω
		$V_{GS}=10\text{ V}$, $I_D=44\text{ A}$, $T_j=150\text{ °C}$	-	0.11	-	
Gate resistance	R_G	$f=1\text{ MHz}$, open drain	-	1.3	-	Ω

Parameter	Symbol	Conditions	Values			Unit
			min.	typ.	max.	

Dynamic characteristics

Input capacitance	C_{iss}	$V_{GS}=0\text{ V}, V_{DS}=100\text{ V},$ $f=1\text{ MHz}$	-	6800	-	pF
Output capacitance	C_{oss}		-	320	-	
Effective output capacitance, energy related ⁴⁾	$C_{o(er)}$	$V_{GS}=0\text{ V}, V_{DS}=0\text{ V}$ to 480 V	-	310	-	
Effective output capacitance, time related ⁵⁾	$C_{o(tr)}$		-	820	-	
Turn-on delay time	$t_{d(on)}$	$V_{DD}=400\text{ V},$ $V_{GS}=10\text{ V}, I_D=44\text{ A},$ $R_G=3.3\ \Omega$	-	30	-	ns
Rise time	t_r		-	20	-	
Turn-off delay time	$t_{d(off)}$		-	100	-	
Fall time	t_f		-	10	-	

Gate Charge Characteristics

Gate to source charge	Q_{gs}	$V_{DD}=400\text{ V}, I_D=44\text{ A},$ $V_{GS}=0\text{ to }10\text{ V}$	-	34	-	nC
Gate to drain charge	Q_{gd}		-	51	-	
Gate charge total	Q_g		-	150	190	
Gate plateau voltage	$V_{plateau}$		-	5.0	-	V

Reverse Diode

Diode forward voltage	V_{SD}	$V_{GS}=0\text{ V}, I_F=44\text{ A},$ $T_J=25\text{ }^\circ\text{C}$	-	0.9	1.2	V
Reverse recovery time	t_{rr}	$V_R=400\text{ V}, I_F=I_S,$ $di_F/dt=100\text{ A}/\mu\text{s}$	-	600	-	ns
Reverse recovery charge	Q_{rr}		-	17	-	μC
Peak reverse recovery current	I_{rrm}		-	60	-	A

¹⁾ Pulse width t_p limited by $T_{j,max}$

²⁾ Repetitive avalanche causes additional power losses that can be calculated as $P_{AV}=E_{AR} \cdot f$.

³⁾ $I_{SD} \leq I_D, di/dt \leq 100\text{ A}/\mu\text{s}, V_{DClink} = 400\text{ V}, V_{peak} < V_{(BR)DSS}, T_J < T_{j,max}$, identical low side and high side switch

⁴⁾ $C_{o(er)}$ is a fixed capacitance that gives the same stored energy as C_{oss} while V_{DS} is rising from 0 to 80% V_{DSS} .

⁵⁾ $C_{o(tr)}$ is a fixed capacitance that gives the same charging time as C_{oss} while V_{DS} is rising from 0 to 80% V_{DSS} .

1 Power dissipation

$P_{tot}=f(T_C)$

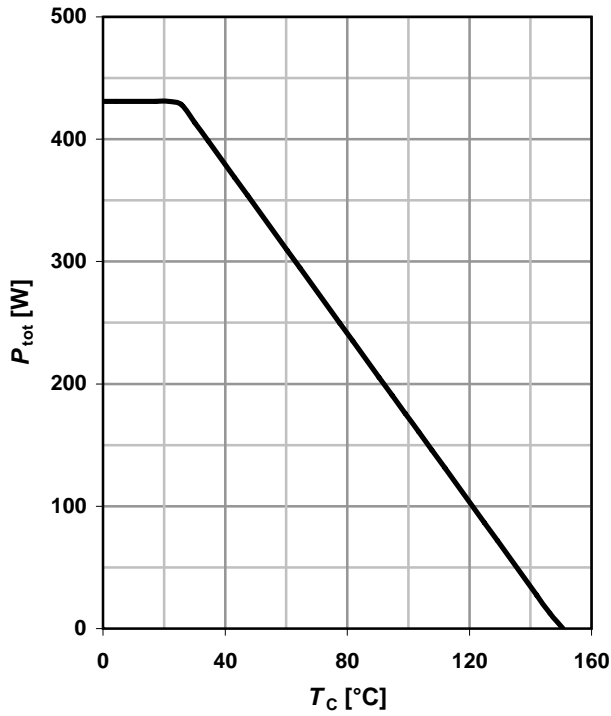

2 Safe operating area

$I_D=f(V_{DS}); T_C=25\text{ °C}; D=0$

parameter: t_p

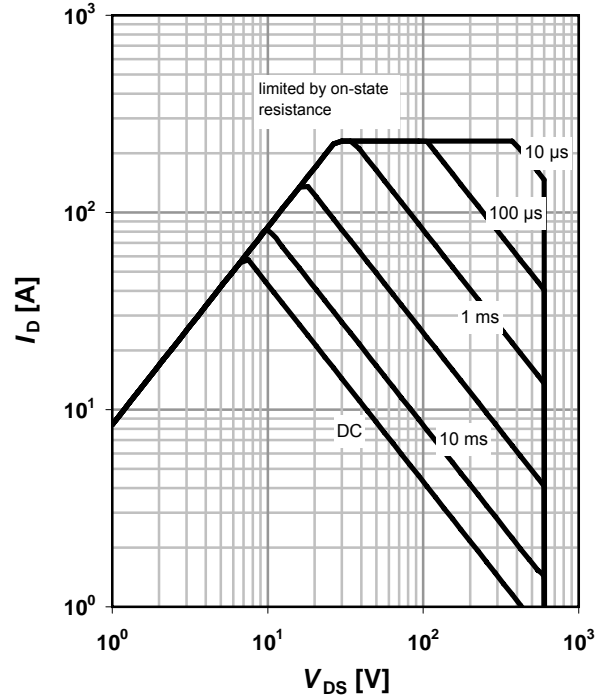

3 Max. transient thermal impedance

$Z_{(thJC)}=f(t_p)$

parameter: $D=t_p/T$

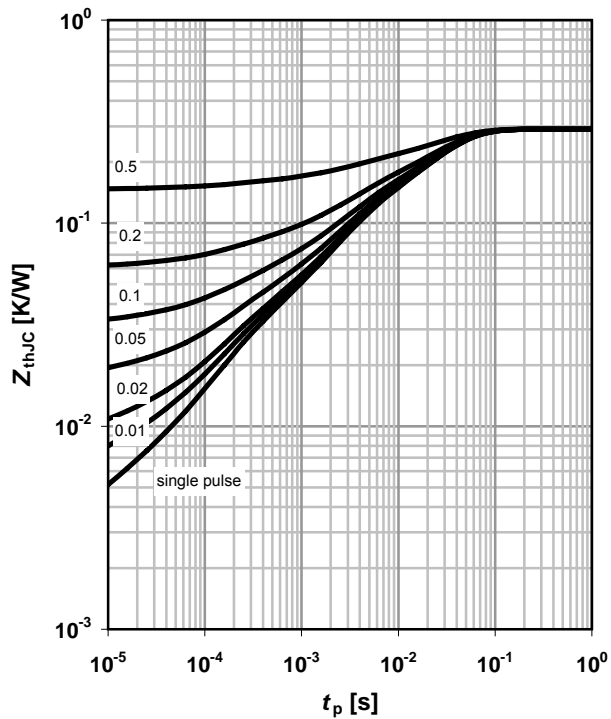

4 Typ. output characteristics

$I_D=f(V_{DS}); T_j=25\text{ °C}$

parameter: V_{GS}

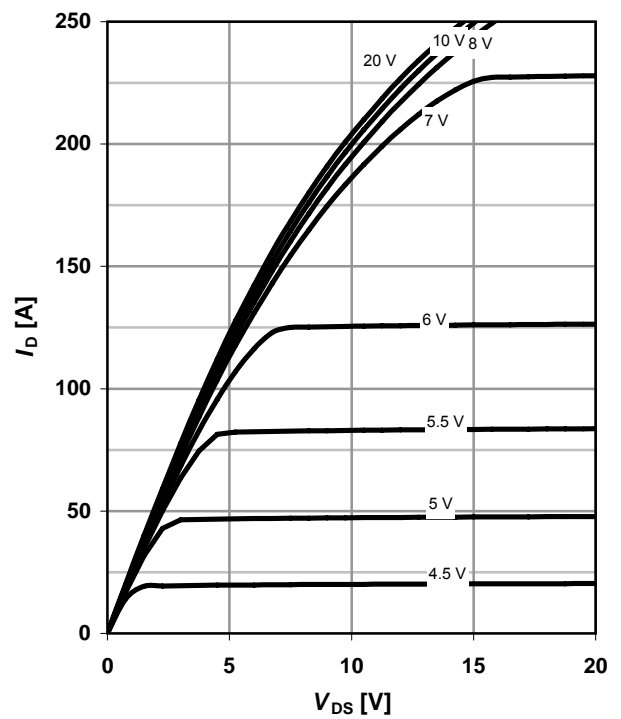

5 Typ. output characteristics

$I_D=f(V_{DS}); T_j=150\text{ }^\circ\text{C}$

parameter: V_{GS}

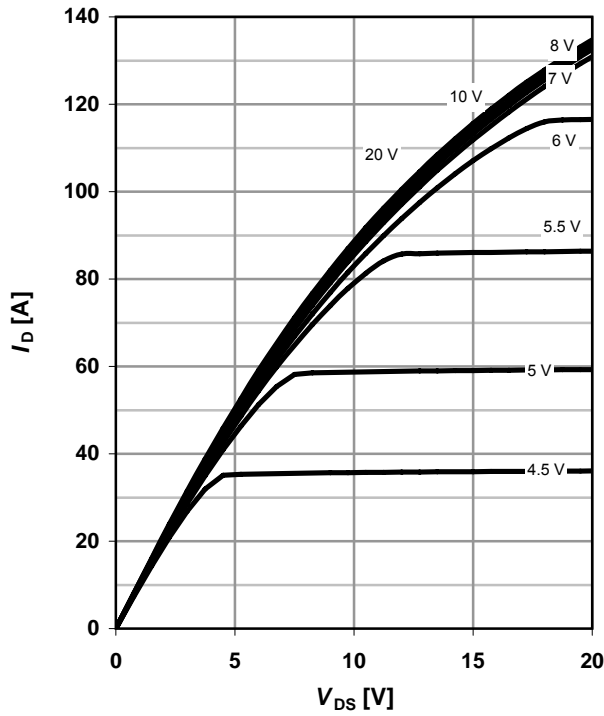

6 Typ. drain-source on-state resistance

$R_{DS(on)}=f(I_D); T_j=150\text{ }^\circ\text{C}$

parameter: V_{GS}

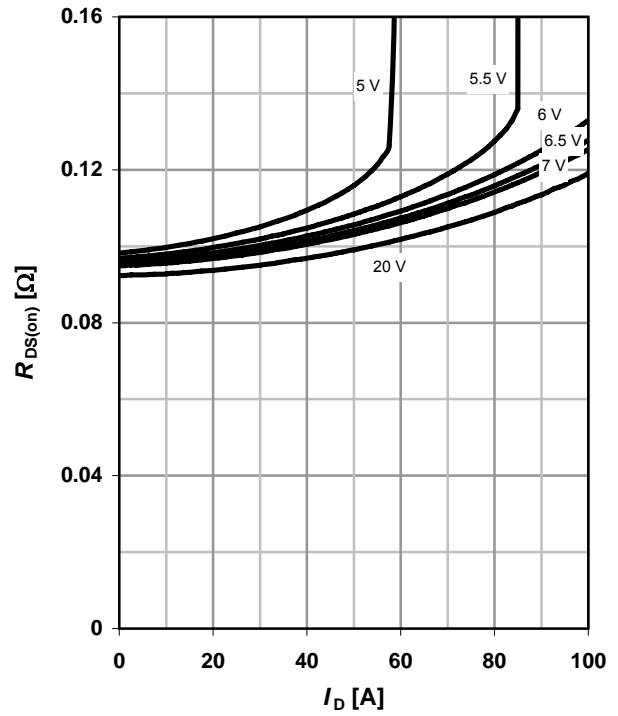

7 Drain-source on-state resistance

$R_{DS(on)}=f(T_j); I_D=44\text{ A}; V_{GS}=10\text{ V}$

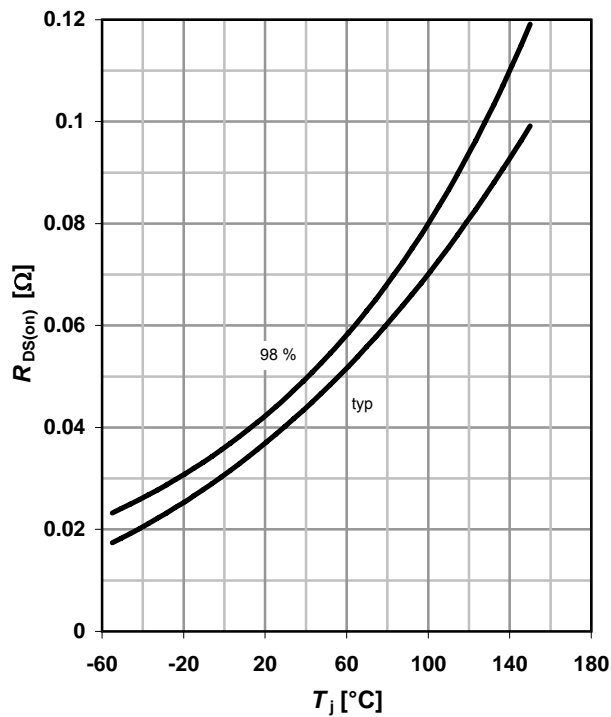

8 Typ. transfer characteristics

$I_D=f(V_{GS}); |V_{DS}|>2|I_D|R_{DS(on)max}$

parameter: T_j

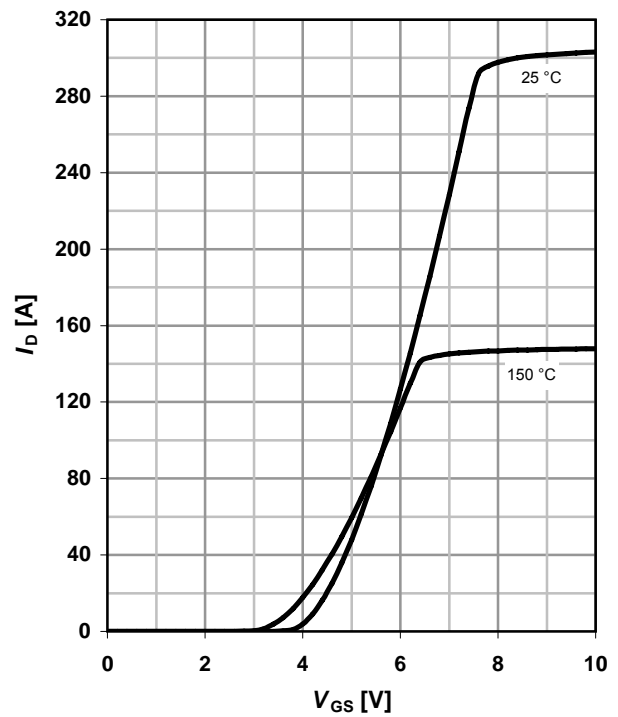

9 Typ. gate charge

$V_{GS}=f(Q_{gate}); I_D=44\text{ A pulsed}$

parameter: V_{DD}

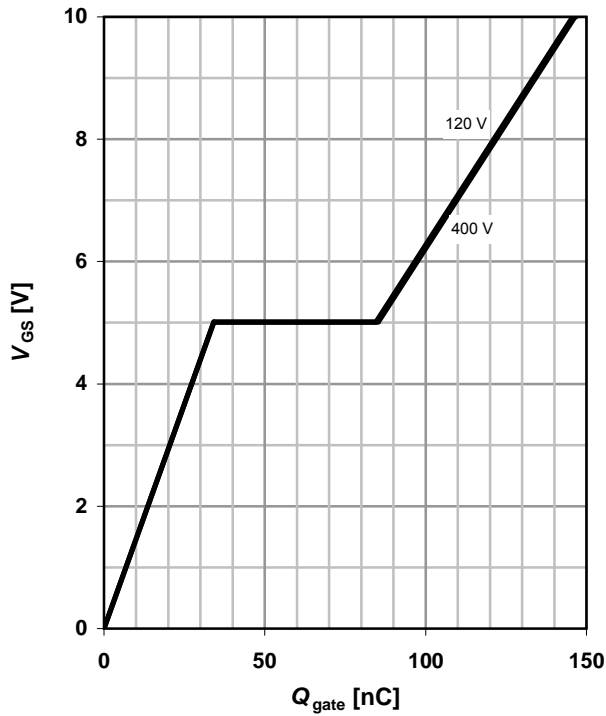

10 Forward characteristics of reverse diode

$I_F=f(V_{SD})$

parameter: T_j

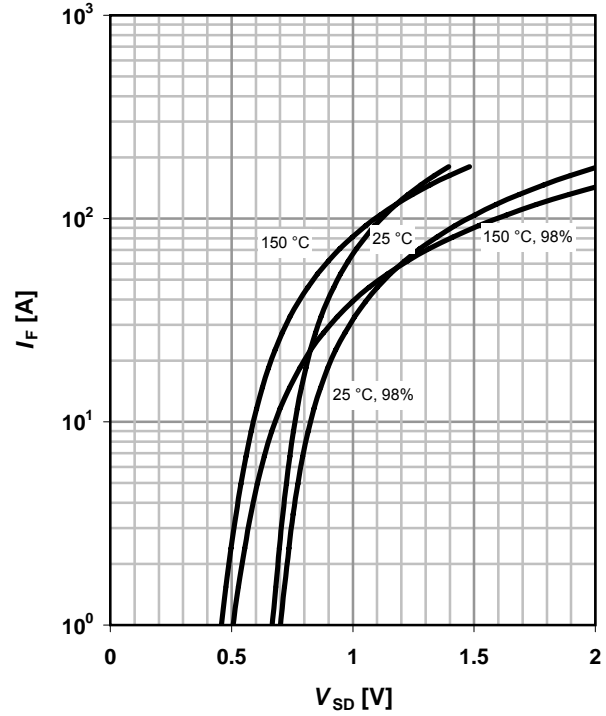

11 Avalanche energy

$E_{AS}=f(T_j); I_D=11\text{ A}; V_{DD}=50\text{ V}$

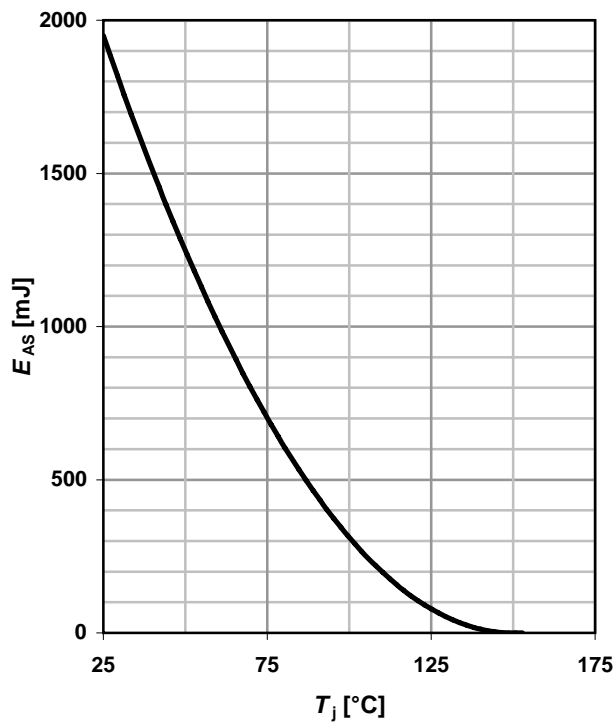

12 Drain-source breakdown voltage

$V_{BR(DSS)}=f(T_j); I_D=0.25\text{ mA}$

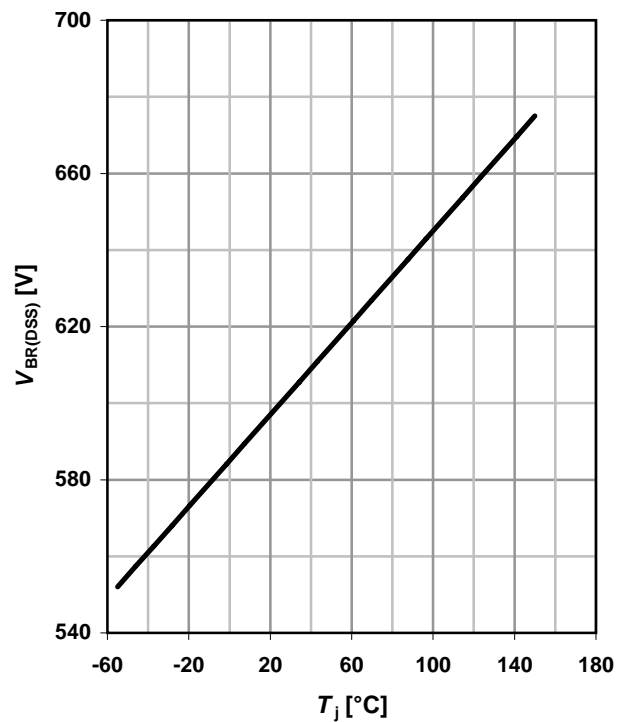

13 Typ. capacitances

$C=f(V_{DS}); V_{GS}=0\text{ V}; f=1\text{ MHz}$

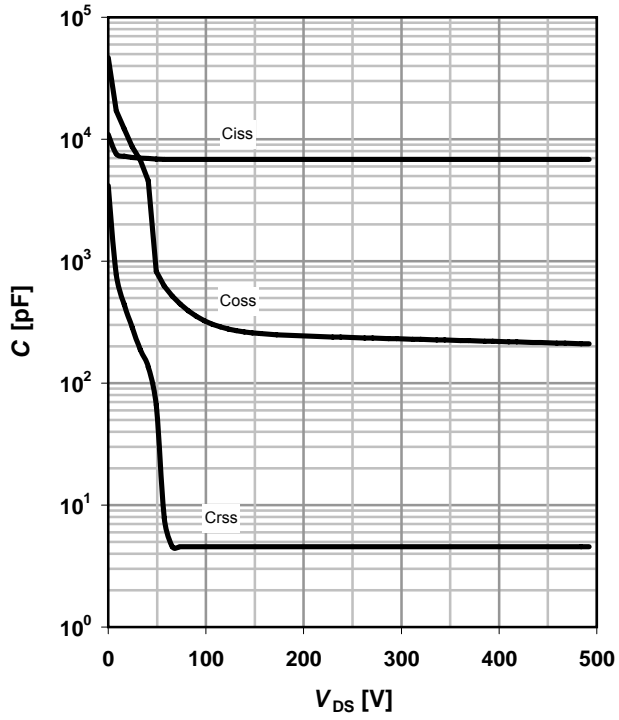

14 Typ. Coss stored energy

$E_{oss}=f(V_{DS})$

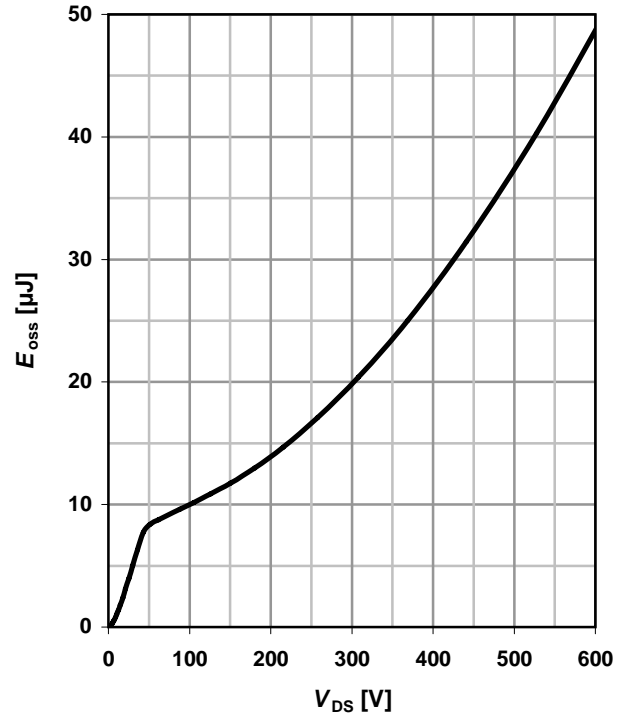

Definition of diode switching characteristics

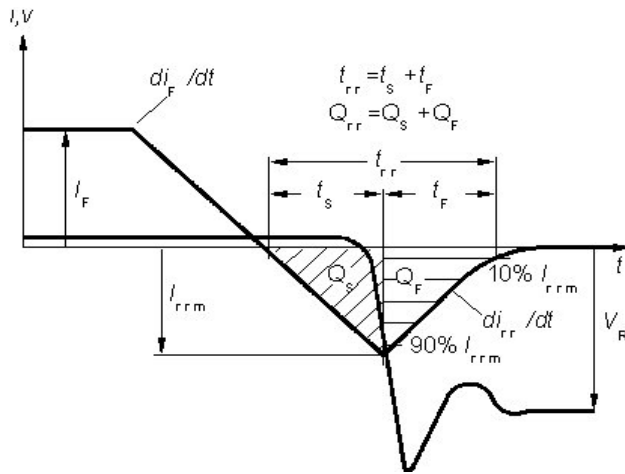

PG-TO-247-3: Outlines

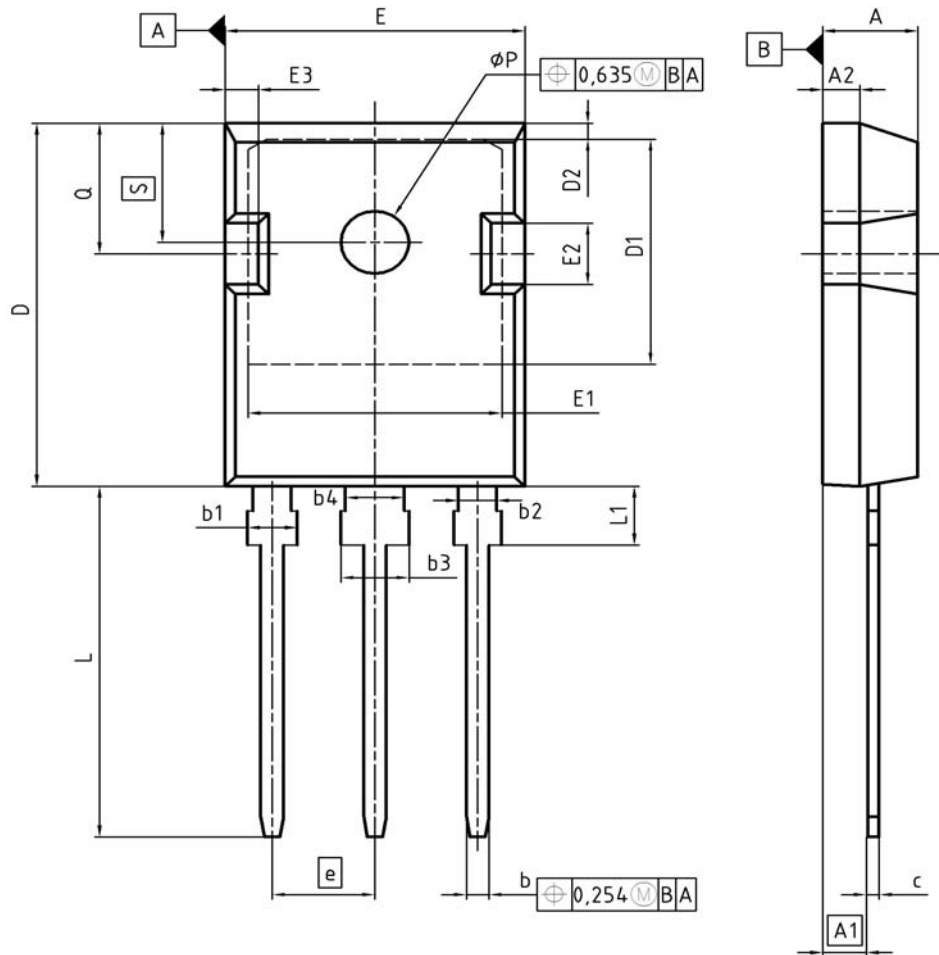

DIM	MILLIMETERS		INCHES	
	MIN	MAX	MIN	MAX
A	4.90	5.16	0.193	0.203
A1	2.27	2.53	0.089	0.099
A2	1.85	2.11	0.073	0.083
b	1.07	1.33	0.042	0.052
b1	1.90	2.41	0.075	0.095
b2	1.90	2.16	0.075	0.085
b3	2.87	3.38	0.113	0.133
b4	2.87	3.13	0.113	0.123
c	0.55	0.68	0.022	0.027
D	20.82	21.10	0.820	0.831
D1	16.25	17.65	0.640	0.695
D2	1.05	1.35	0.041	0.053
E	15.70	16.03	0.618	0.631
E1	13.10	14.15	0.516	0.557
E2	3.68	5.10	0.145	0.201
E3	1.68	2.60	0.066	0.102
e	5.44		0.214	
N	3		3	
L	19.80	20.31	0.780	0.799
L1	4.17	4.47	0.164	0.176
phi P	3.50	3.70	0.138	0.146
Q	5.49	6.00	0.216	0.236
S	6.04	6.30	0.238	0.248

DOCUMENT NO.
Z8B00003327

SCALE

EUROPEAN PROJECTION

ISSUE DATE
17-12-2007

REVISION
03

Published by
Infineon Technologies AG
81726 Munich, Germany
© 2010 Infineon Technologies AG
All Rights Reserved.

Legal Disclaimer

The information given in this document shall in no event be regarded as a guarantee of conditions or characteristics ("Beschaffenheitsgarantie"). With respect to any examples or hints given herein, any typical values stated herein and/or any information regarding the application of the device, Infineon Technologies hereby disclaims any and all warranties and liabilities of any kind, including without limitation warranties of non-infringement of intellectual property rights of any third party.

Information

For further information on technology, delivery terms and conditions and prices please contact your nearest Infineon Technologies Office (www.infineon.com).

Warnings

Due to technical requirements components may contain dangerous substances. For information on the types in question please contact your nearest Infineon Technologies Office.
Infineon Technologies Components may only be used in life-support devices or systems with the express written approval of Infineon Technologies, if a failure of such components can reasonably be expected to cause the failure of that life-support device or system, or to affect the safety or effectiveness of that device or system. Life support devices or systems are intended to be implanted in the human body, or to support and/or maintain and sustain and/or protect human life. If they fail, it is reasonable to assume that the health of the user or other persons may be endangered.

NOTIFICATION



N° 040/10

Information on N-Channel MOSFET products designed for automotive applications

Products affected:

SalesName	Package
IPB60R099CPA	PG-TO263-3-2
IPB60R199CPA	PG-TO263-3-2
IPB60R299CPA	PG-TO263-3-2
IPC60R075CPA	Bare Die
IPI60R099CPA	PG-TO262-3-1
IPP60R099CPA	PG-TO220-3-1
IPW60R045CPA	PG-TO247-3-41
IPW60R075CPA	PG-TO247-3-41
IPW60R099CPA	PG-TO247-3-41

Dear Customer,

The devices listed for this notification are sensitive to hard commutation of the conducting body diode. This operating condition can occur in half-bridge configurations used in ZVS phase shift and resonant switching PWM converters. Using the device under such conditions may result in violation of the datasheet specification limits and may lead to permanent damage of the device.

Please take care that in the context of the application described above the datasheet limits are not exceeded.

Best Regards

Michael Paulu

If you have any questions, please do not hesitate to contact your local Sales office.